

TEKNİK ÜRÜNLER

FİYAT LİSTESİ

2019/1



İÇİNDEKİLER:

ISITMA - SİHHİ TESİSAT VALFLERİ			
Termostatik Radyatör Valfleri	3	Stop Valfler	38
Termostatik Radyatör Valfleri (Çift Akış Yönlü)	5	Kosva Valfler	38
Termostatik Radyatör Valfleri (Debi İç Ayar Tertibatlı)	7	Filtreler ve Çekvalfler	39
Termostatik Radyatör Valfleri (Pex Boru Bağlantılı)	8	Flatörler	41
Termostatik Radyatör Valfleri (Kompakt Tip Panel Radyatörler İçin)	9	Su Basınç Düşürücü Valfler	42
Radyatör Valfleri	12	Küresel Tip Musluklar	44
Krom Radyatör Valfleri (Havlupan Tipi Radyatörler İçin)	15	YERDEN ISITMA SİSTEMLERİ	
Radyatör Geri Dönüş Valfleri	17	Debimetreli Kolektör	47
H-Valfler	19	Debimetresiz Kolektör	48
Rakorlar	20	Termal Kontrol Vanası (Aktüatör)	49
Pex Boru Bağlantı Elemanları	22	2-Yollu 1" Termal Kontrol Vanası	49
Yerden Dağıtım - Isıtma Sistemleri - Kolektörler	23	Ana Kontrol Ünitesi	49
Kolektör Bağlantı Elemanları	26	Oda Termostatı	50
Otomatik Havalandırıcı ve Purjörler	27	Askı Seti	50
Emniyet Valfleri	28	Hava/Su Boşaltma Seti	50
Su Tesizat/Kombi Emniyet Valfi	28	1" Rakorlu Küresel Valf	51
Doğalgaz Küresel Valfler	29	1" Termokupl Çıkışlı Rakorlu Küresel Valf	51
Kilitlemeli Doğalgaz Küresel Valfler	29	Pex Bağlantı Rakor Grubu	51
İçme Suyu Küresel Valfleri	31	1" Kolektör Kör Tapası	51
Endüstriyel Tip Küresel Valfler	32	YANGIN SİSTEMLERİ	
Üç Yollu Küresel Valfler	34	Sprinkler	53
Mini Küresel Valfler	35	İtfaiye Kat Bağlantı Vanası	55
Rakorlu Mini Küresel Valfler	35	Yangın Dolap Vanası	55
Hortum Uçlu Mini Küresel Valfler	36	Test ve Drenaj Vanası	56
Şiber Valfler	37	Küresel Valfler	57





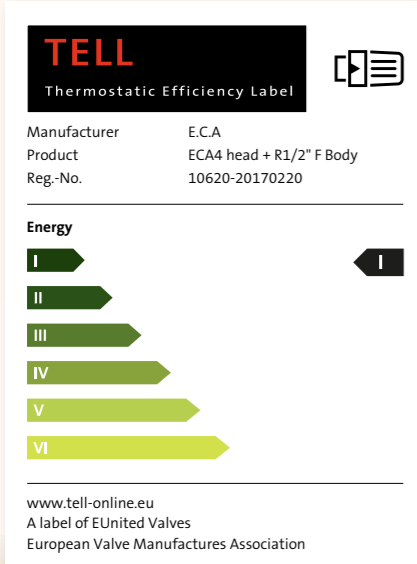

%30 'A VARAN ENERJİ TASARRUFU

**TÜRKİYE'NİN İLK VE TEK
I. SINIF ENERJİ
VERİMLİLİĞİNE UYGUN
YERLİ ÜRETİM
TERMOSTATİK RADYATÖR VANASI!**

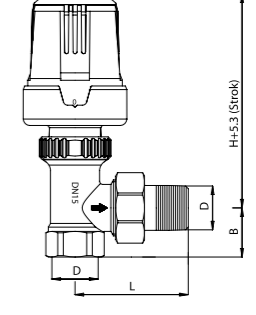

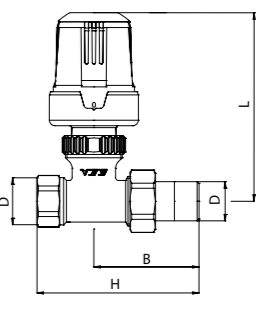
- * E.C.A. termostatik radyatör vanaları, normal radyatör vanalarına göre %30'a varan enerji tasarrufu sağlar.
- ** E.C.A.2 ve E.C.A.4 kafa grubuna sahip termostatik radyatör valflerimiz EUnited Valves tarafından TELL ürün sınıflandırma kapsamında I. sınıf enerji verimliliği seviyesinde onaylanmıştır.
- *** E.C.A. termostatik radyatör valfleri bir sezonda kendisini amorti eder.

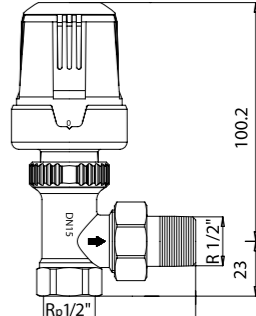

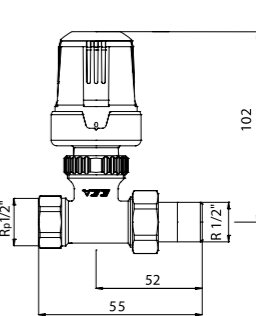



TERMOSTATİK RADYATÖR VALFLERİ
EN 215, TS EN 215, %30'a varan Enerji Tasarrufu

ÜRÜN	ÜRÜN KODU	ÜRÜN ADI	TEKNİK ÇİZİM	LİSTE FİYATI ₺	ÜRÜN KT. AD.														
	602 120 162	1/2" TERMOSTATİK RADYATÖR VALFİ KÖŞE Krom - TRV		128	7														
	602 120 181	3/4" TERMOSTATİK RADYATÖR VALFİ KÖŞE Krom - TRV		147	7														
		<table border="1"> <thead> <tr> <th>Ürün Kodu</th> <th>D</th> <th>L</th> <th>B</th> <th>H</th> </tr> </thead> <tbody> <tr> <td>602 120 162</td> <td>R 1/2"</td> <td>53</td> <td>23</td> <td>100.2</td> </tr> <tr> <td>602 120 181</td> <td>R 3/4"</td> <td>53</td> <td>26</td> <td>100.2</td> </tr> </tbody> </table>	Ürün Kodu	D	L	B	H	602 120 162	R 1/2"	53	23	100.2	602 120 181	R 3/4"	53	26	100.2		
Ürün Kodu	D	L	B	H															
602 120 162	R 1/2"	53	23	100.2															
602 120 181	R 3/4"	53	26	100.2															
	602 120 164	1/2" TERMOSTATİK RADYATÖR VALFİ DÜZ Krom - TRV		128	7														
	602 120 183	3/4" TERMOSTATİK RADYATÖR VALFİ DÜZ Krom - TRV		147	7														
		<table border="1"> <thead> <tr> <th>Kod No</th> <th>D</th> <th>L</th> <th>B</th> <th>H</th> </tr> </thead> <tbody> <tr> <td>602 120 164</td> <td>R 1/2"</td> <td>82</td> <td>50</td> <td>50</td> </tr> <tr> <td>602 120 183</td> <td>R 3/4"</td> <td>98</td> <td>65</td> <td>65</td> </tr> </tbody> </table>	Kod No	D	L	B	H	602 120 164	R 1/2"	82	50	50	602 120 183	R 3/4"	98	65	65		
Kod No	D	L	B	H															
602 120 164	R 1/2"	82	50	50															
602 120 183	R 3/4"	98	65	65															
	602 120 531	1/2" TERMOSTATİK RADYATÖR VALFİ KÖŞE TRV3 • 15°C Ortam Sıcaklığı Alt Limitli		73	22														
	602 120 532	1/2" TERMOSTATİK RADYATÖR VALFİ DÜZ TRV3 • 15°C Ortam Sıcaklığı Alt Limitli		73	22														

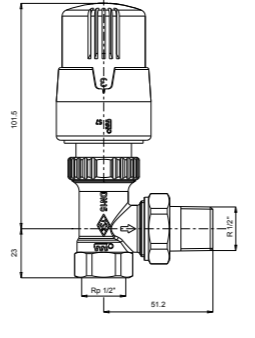
- Fiyatlara KDV ayrıca dahil edilir. Tavsiye edilen bayi satış fiyatıdır.
- Standart belgelerine ve belgelendirme kapsamındaki ürünlere www.eca.com.tr, www.valf.com.tr üzerinden ulaşılabilir.

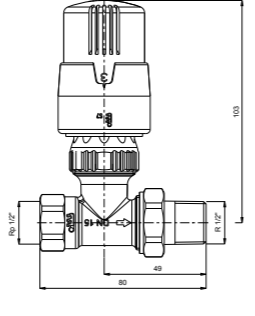
TERMOSTATİK RADYATÖR VALFLERİ

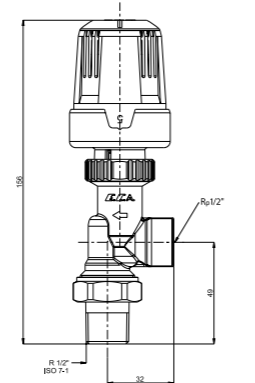
EN 215, TS EN 215, %30'a varan Enerji Tasarrufu

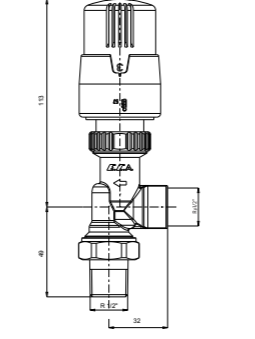
ÜRÜN	ÜRÜN KODU	ÜRÜN ADI	TEKNİK ÇİZİM	LİSTE FİYATI ₺	ÜRÜN KT. AD.
	602 120 755	1/2" TERMOSTATİK RADYATÖR VALFİ KÖŞE TRV4 • 15°C Ortam Sıcaklığı Alt Limitli		77	22
	602 120 756	1/2" TERMOSTATİK RADYATÖR VALFİ DÜZ TRV4 • 15°C Ortam Sıcaklığı Alt Limitli		77	22
	602 120 528*	1/2" YATAY EKSENLİ TERMOSTATİK RADYATÖR VALFİ TRV3 • 15°C Ortam Sıcaklığı Alt Limitli		91	22
	602 120 815*	1/2" YATAY EKSENLİ TERMOSTATİK RADYATÖR VALFİ TRV4 • 15°C Ortam Sıcaklığı Alt Limitli		95	22

TERMOSTATİK RADYATÖR VALFLERİ (çift akış yönlü tipler)

EN 215, TS EN 215, %30'a varan Enerji Tasarrufu

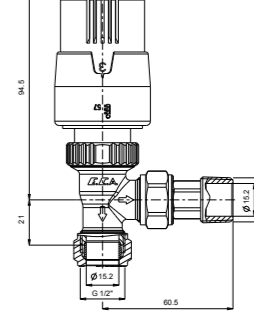
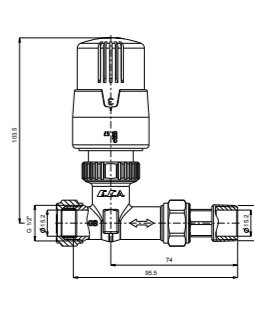
ÜRÜN	ÜRÜN KODU	ÜRÜN ADI	TEKNİK ÇİZİM	LİSTE FİYATI ₺	ÜRÜN KT. AD.
	602 120 166*	1/2" TERMOSTATİK RADYATÖR VALFİ Krom - TRV • Çift akış yönlü kullanılabilir, giriş çapı Ø 15 mm.		164	7
	602 120 759*	1/2" TERMOSTATİK RADYATÖR VALFİ TRV4 • Çift akış yönlü kullanılabilir, giriş çapı Ø 15 mm. Bakır boru • 15°C Ortam Sıcaklığı Alt Limitli		97	22
	602 120 760*	1/2" TERMOSTATİK RADYATÖR VALFİ TRV4 • Çift akış yönlü kullanılabilir, giriş çapı Ø 15 mm. Bakır boru • 15°C Ortam Sıcaklığı Alt Limitli		105	22
	610 714 004 01*	BAĞLANTI NİPELİ		15	7

* İlgili ürünler sipariş bazında özel üretilir.

• Fiyatlara KDV ayrıca dahil edilir. Tavsiye edilen bayi satış fiyatıdır.

• Standart belgelerine ve belgelendirme kapsamındaki ürünlere www.eca.com.tr, www.valf.com.tr üzerinden ulaşılabilir. SİRKÜLER NO: S1920101

TERMOSTATİK RADYATÖR VALFLERİ (çift akış yönlü)

Çift akış yönlü Termostatik Radyatör valfi ile gerek kullanıcıya gerekse tesisatçıya yönelik yeni çözümler sunulmaktadır.

Geliştirilen yeni tipte Termostatik radyatör valflerinin sağladığı tasarruf ve konforun yanında, valfin kalorifer tesisatı ve radyatöre montajında alışlagelmiş klasik bağlantı pozisyonunun dışında mahal, çalışma, montaj ve kullanım kolaylığı dikkate alınıp, farklı konumlandırma yaparak monte edilmesi prensibinden yola çıkılmıştır. Akışkanın radyatör valfine her iki bağlantı ucundan giriş ya da çıkış yapabilmesi özelliği sayesinde radyatör valfinin değişik konumlarda radyatöre bağlantısı söz konusu olmaktadır.

Likit sensörlü termostat grubu bulunan Çift akış yönlü Termostatik Radyatör valfi bakır ve plastik boru bağlantı seçeneğinin yanında, kullanılacak bağlantı nipelini ile mevcut demir borulu kalorifer tesisatlarına da kolaylıkla monte edilebilmektedir.

Çift akış yönlü Termostatik Radyatör valfiyle kullanıcıya;

- Aynı valfin radyatöre farklı pozisyonlarda bağlantı seçeneği,
- Bağlantı nipelinin boyunda montaj imkanları doğrultusunda ayarlama yapabilme,
- Her bir mahal sıcaklığını ayrı ayrı kontrol ederek konforlu ve ekonomik ısınmanın temini,
- Ortam içindeki diğer ısı kaynaklarında yayılan enerjinin algılanarak tasarrufa dönüşümü,
- Termostatik Radyatör valfini üç farklı şekilde ayarlama ve sabitleme,
- Fabrika çıkış ayar konumunda olduğu gibi TRV2 ve TRV3 ürünlerimiz 5-29°C arasında, TRV4 ürünlerimiz 6-28 °C arasında istenilen herhangi bir değere ayarlama imkanı,
- Tek bir değere sabitleme imkanı,
- İstenilen iki değer arasında kullanabilme imkanı,
- Bir sezonda kendini amorti edebilme,
- Estetik görünüm,
- Uzun ömürlü, bakım gerektirmeyen, kolay bir kullanım sunar.

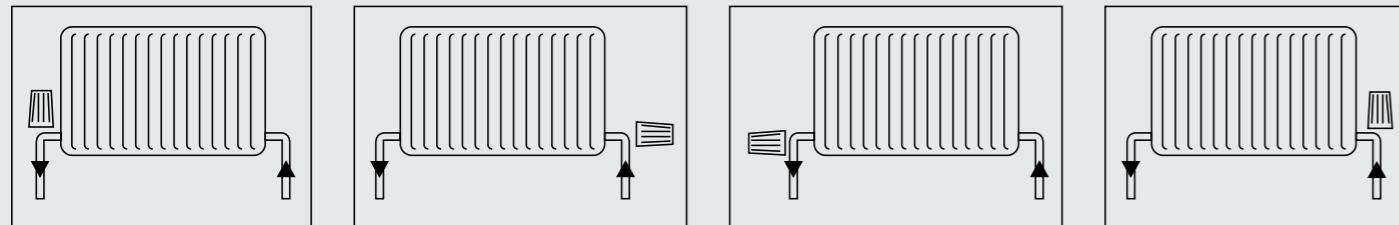

TERMOSTATİK RADYATÖR VALFLERİ (Debi İç Ayar Tertibatlı) EN 215, TS EN 215, %30'a varan Enerji Tasarrufu







ÜRÜN	ÜRÜN KODU	ÜRÜN ADI	TEKNİK ÇİZİM	LİSTE FİYATI ₺	ÜRÜN KT. AD.
	602 120 256*	1/2" TERMOSTATİK RADYATÖR VALFİ, DÜZ TRV2		127	7
	602 120 258*	1/2" TERMOSTATİK RADYATÖR VALFİ, KÖŞE TRV2		127	7
	602 120 257*	1/2" TERMOSTATİK RADYATÖR VALFİ, DÜZ Krom - TRV		139	7
	602 120 259*	1/2" TERMOSTATİK RADYATÖR VALFİ, KÖŞE Krom - TRV		139	7

* İlgili ürünler sipariş bazında özel üretilir.

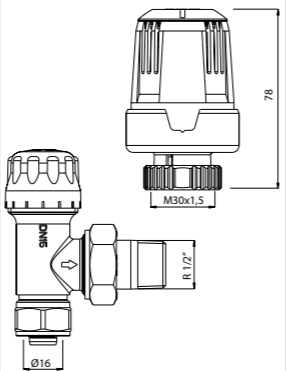

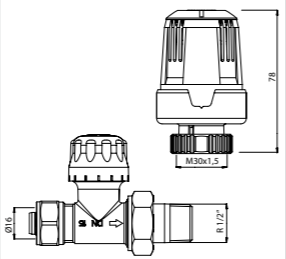
• Fiyatlara KDV ayrıca dahil edilir. Tavsiye edilen bayi satış fiyatıdır.

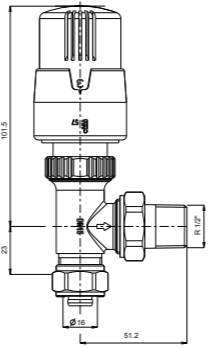
• Standart belgelerine ve belgelendirme kapsamındaki ürünlere www.eca.com.tr, www.valf.com.tr üzerinden ulaşılabilir.
SİRKÜLER NO: S1920101

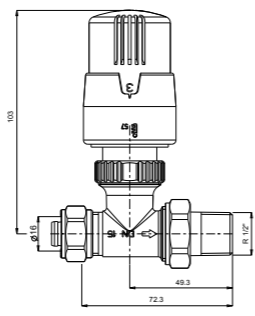
TERMOSTATİK RADYATÖR VALFLERİ (Pex Boru Bağlantılı) EN 215, TS EN 215, %30'a varan Enerji Tasarrufu

ÜRÜN	ÜRÜN KODU	ÜRÜN ADI	TEKNİK ÇİZİM	LİSTE FİYATI ₺	ÜRÜN KT. AD.
	602 120 549	TERMOSTATİK RADYATÖR VALFİ, KÖŞE (Ø 16 X 2 mm) - Pex TRV3 • 15°C Ortam Sıcaklığı Alt Limitli		80	22
	602 120 548	TERMOSTATİK RADYATÖR VALFİ, DÜZ (Ø 16 X 2 mm) - Pex TRV3 • 15°C Ortam Sıcaklığı Alt Limitli		80	22
	602 120 780	TERMOSTATİK RADYATÖR VALFİ, KÖŞE (Ø 16 X 2 mm) - Pex TRV4 • 15°C Ortam Sıcaklığı Alt Limitli		84	22
	602 120 779	TERMOSTATİK RADYATÖR VALFİ, DÜZ (Ø 16 X 2 mm) - Pex TRV4 • 15°C Ortam Sıcaklığı Alt Limitli		84	22

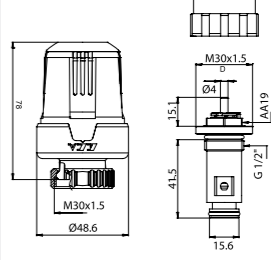
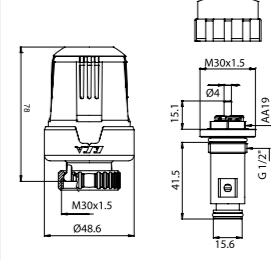
TERMOSTATİK RADYATÖR VALFLERİ (Kompakt Tip Panel Radyatörler İçin) EN 215, TS EN 215, %30'a varan Enerji Tasarrufu

ÜRÜN	ÜRÜN KODU	ÜRÜN ADI	TEKNİK ÇİZİM	LİSTE FİYATI ₺	ÜRÜN KT. AD.
	602 120 325	TERMOSTATİK KOMPAKT RADYATÖR VALFİ TRV2 + iç kompakt ventil • Dıştan contalı, uzun tip (44 mm) • Debi içi ayarlı valfi ile birlikte		104	7
	602 120 326	TERMOSTATİK KOMPAKT RADYATÖR VALFİ Krom - TRV + iç kompakt ventil • Dıştan contalı, uzun tip (44 mm) • Debi içi ayarlı valfi ile birlikte		113	7
	602 120 540	TERMOSTATİK KOMPAKT RADYATÖR VALFİ TRV3 + iç kompakt ventil • Alından basmalı, kısa tip (35 mm) • Debi içi ayarlı valfi ile birlikte • 15°C Ortam Sıcaklığı Alt Limitli		69	7
	602 120 541	TERMOSTATİK KOMPAKT RADYATÖR VALFİ TRV3 + iç kompakt ventil • Dıştan contalı, uzun tip (44 mm) • Debi içi ayarlı valfi ile birlikte • 15°C Ortam Sıcaklığı Alt Limitli		69	7



TERMOSTATİK RADYATÖR VALFLERİ (Kompakt Tip Panel Radyatörler İçin)

EN 215, TS EN 215, %30'a varan Enerji Tasarrufu

ÜRÜN	ÜRÜN KODU	ÜRÜN ADI	TEKNİK ÇİZİM	LİSTE FİYATI ₺	ÜRÜN KT. AD.
	602 120 640	TERMOSTATİK KOMPAKT RADYATÖR VALFİ TRV3 + iç kompakt ventil		69	7
		<ul style="list-style-type: none"> İçten contalı tip (41,3 mm) Debi içi ayarlı valfi ile birlikte 15°C Ortam Sıcaklığı Alt Limitli 			
	602 120 796	TERMOSTATİK KOMPAKT RADYATÖR VALFİ TRV4 + iç kompakt ventil		73	7
		<ul style="list-style-type: none"> Dıştan contalı, uzun tip (44 mm) Debi içi ayarlı valfi ile birlikte 15°C Ortam Sıcaklığı Alt Limitli 			
	602 120 813	TERMOSTATİK KOMPAKT RADYATÖR VALFİ TRV4 + iç kompakt ventil		73	7
		<ul style="list-style-type: none"> İçten contalı tip (41,3 mm) Debi içi ayarlı valfi ile birlikte 15°C Ortam Sıcaklığı Alt Limitli 			
	602 120 814	TERMOSTATİK KOMPAKT RADYATÖR VALFİ TRV4 + iç kompakt ventil		73	7
		<ul style="list-style-type: none"> Alından basmalı, kısa tip (35 mm) Debi içi ayarlı valfi ile birlikte 15°C Ortam Sıcaklığı Alt Limitli 			

TERMOSTATİK RADYATÖR VALFLERİ

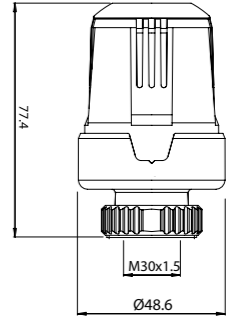

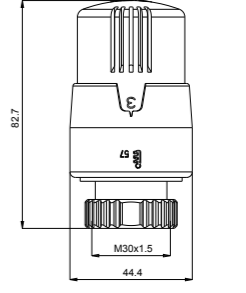



EN 215, TS EN 215, %30'a varan Enerji Tasarrufu



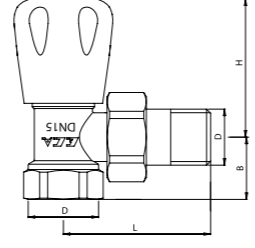

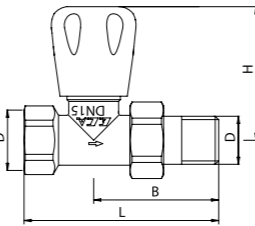

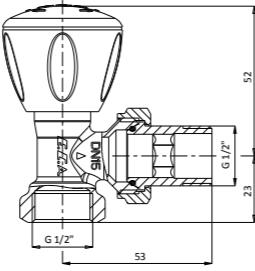
ÜRÜN	ÜRÜN KODU	ÜRÜN ADI	TEKNİK ÇİZİM	LİSTE FİYATI ₺	ÜRÜN KT. AD.
	602 120 530	TERMOSTAT KAFİ GRUBU TRV3		52	14
		<ul style="list-style-type: none"> 15°C Ortam Sıcaklığı Alt Limitli 			
	602 120 170	TERMOSTAT KAFİ GRUBU Krom - TRV		97	14
	602 120 754	TERMOSTAT KAFİ GRUBU TRV4		55	24
		<ul style="list-style-type: none"> 15°C Ortam Sıcaklığı Alt Limitli 			

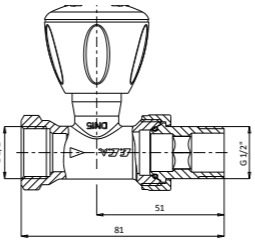
• Fiyatlara KDV ayrıca dahil edilir. Tavsiye edilen bayi satış fiyatıdır.

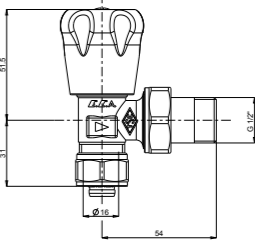
• Standart belgelerine ve belgelendirme kapsamındaki ürünlere www.eca.com.tr, www.valf.com.tr üzerinden ulaşılabilir. SİRKÜLER NO: S1920101

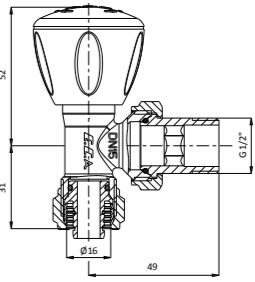
RADYATÖR VALFLERİ

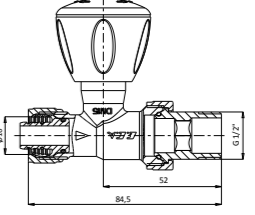

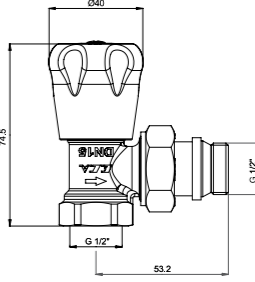

ÜRÜN	ÜRÜN KODU	ÜRÜN ADI	LİSTE FİYATI ₺	ÜRÜN KT. AD.															
	102 120 332	1/2" RV2 KÖŞE RADYATÖR VALFİ	40	50															
	102 120 333	3/4" RV2 KÖŞE RADYATÖR VALFİ	59	35															
		<ul style="list-style-type: none"> • TS 579 • Sıcak Sulu Isıtma sistemleri, 10bar, 120°C <table border="1"> <thead> <tr> <th>Kod. No</th> <th>D</th> <th>L</th> <th>B</th> <th>H</th> </tr> </thead> <tbody> <tr> <td>102 120 332</td> <td>1/2"</td> <td>54.4</td> <td>23</td> <td>51.5</td> </tr> <tr> <td>102 120 333</td> <td>3/4"</td> <td>61.5</td> <td>26</td> <td>51.5</td> </tr> </tbody> </table> 	Kod. No	D	L	B	H	102 120 332	1/2"	54.4	23	51.5	102 120 333	3/4"	61.5	26	51.5		
Kod. No	D	L	B	H															
102 120 332	1/2"	54.4	23	51.5															
102 120 333	3/4"	61.5	26	51.5															
	102 120 322	1/2" RV2 DÜZ RADYATÖR VALFİ	45	50															
	102 120 323	3/4" RV2 DÜZ RADYATÖR VALFİ	63	35															
		<ul style="list-style-type: none"> • TS 579 • Sıcak Sulu Isıtma sistemleri, 10bar, 120°C <table border="1"> <thead> <tr> <th>Kod. No</th> <th>D</th> <th>L</th> <th>B</th> <th>H</th> </tr> </thead> <tbody> <tr> <td>102 120 322</td> <td>1/2"</td> <td>83.9</td> <td>53.9</td> <td>58</td> </tr> <tr> <td>102 120 323</td> <td>3/4"</td> <td>96.5</td> <td>60.5</td> <td>58</td> </tr> </tbody> </table> 	Kod. No	D	L	B	H	102 120 322	1/2"	83.9	53.9	58	102 120 323	3/4"	96.5	60.5	58		
Kod. No	D	L	B	H															
102 120 322	1/2"	83.9	53.9	58															
102 120 323	3/4"	96.5	60.5	58															
	602 120 641	1/2" RV3 KÖŞE RADYATÖR VALFİ	32	50															
		<ul style="list-style-type: none"> • TS 579 • Sıcak Sulu Isıtma sistemleri, 10bar, 120°C 																	
	602 120 725	1/2" RV3 DÜZ RADYATÖR VALFİ	35	50															
		<ul style="list-style-type: none"> • TS 579 • Sıcak Sulu Isıtma sistemleri, 10bar, 120°C 																	

ÜRÜN	ÜRÜN KODU	ÜRÜN ADI	TEKNİK ÇİZİM	LİSTE FİYATI ₺	ÜRÜN KT. AD.
	602 120 338	KÖŞE RADYATÖR VALFİ (Ø 16 x 2 mm) - Pex RV2		51	50
		<ul style="list-style-type: none"> • Sıcak Sulu Isıtma sistemleri, 10bar, 120°C 			
	602 120 721	RV3 KÖŞE RADYATÖR VALFİ (Ø 16 x 2 mm) - Pex RV3		35	50
		<ul style="list-style-type: none"> • Sıcak Sulu Isıtma sistemleri, 10bar, 120°C 			
	602 120 722	RV3 DÜZ RADYATÖR VALFİ (Ø 16 x 2 mm) - Pex RV3		37	50
		<ul style="list-style-type: none"> • Sıcak Sulu Isıtma sistemleri, 10bar, 120°C 			
	602 120 552	1/2" RV2 KÖŞE RADYATÖR VALFİ CONTALI		47	50
		<ul style="list-style-type: none"> • TS 579 • Sıcak Sulu Isıtma sistemleri, 10bar, 120°C 			

• Fiyatlara KDV ayrıca dahil edilir. Tavsiye edilen bayi satış fiyatıdır.

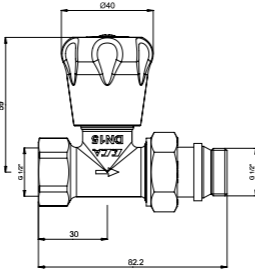
• Standart belgelerine ve belgelendirme kapsamındaki ürünlere www.eca.com.tr, www.valf.com.tr üzerinden ulaşılabilir. SİRKÜLER NO: S1920101

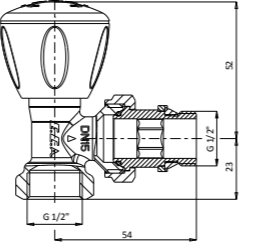
RADYATÖR VALFLERİ

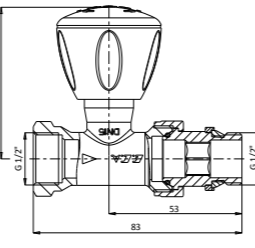
ÜRÜN	ÜRÜN KODU	ÜRÜN ADI	TEKNİK ÇİZİM	LİSTE FİYATI ₺	ÜRÜN KT. AD.
	602 120 553	1/2" RV2 DÜZ RADYATÖR VALFİ CONTALI		52	50
	602 120 723	1/2" RV3 KÖŞE RADYATÖR VALFİ - CONTALI • TS 579 • Sıcak Sulu Isıtma sistemleri, 10bar, 120°C		35	50
	602 120 724	1/2" RV3 DÜZ RADYATÖR VALFİ - CONTALI • TS 579 • Sıcak Sulu Isıtma sistemleri, 10bar, 120°C		37	50

KROM RADYATÖR VALFLERİ (Havlupan Tipi Radyatörler İçin)

ÜRÜN	ÜRÜN KODU	ÜRÜN ADI	TEKNİK ÇİZİM	LİSTE FİYATI ₺	ÜRÜN KT. AD.
	602 120 371	1/2" KROM KÖŞE RADYATÖR VALFİ • TS 579 • Sıcak Sulu Isıtma sistemleri, 10bar, 120°C • Polısajlı krom kaplama		68	42
	602 120 388	1/2" KROM DÜZ RADYATÖR VALFİ • TS 579 • Sıcak Sulu Isıtma sistemleri, 10bar, 120°C • Polısajlı krom kaplama		72	42
	602 120 749	1/2" RV3 KROM KÖŞE RADYATÖR VALFİ • TS 579 • Sıcak Sulu Isıtma sistemleri, 10bar, 120°C • Krom kaplama		48	50
	602 120 750	1/2" RV3 KROM DÜZ RADYATÖR VALFİ • TS 579 • Sıcak Sulu Isıtma sistemleri, 10bar, 120°C • Krom kaplama		53	50

• Fiyatlara KDV ayrıca dahil edilir. Tavsiye edilen bayi satış fiyatıdır.

• Standart belgelerine ve belgelendirme kapsamındaki ürünlere www.eca.com.tr, www.valf.com.tr üzerinden ulaşılabilir.
SİRKÜLER NO: S1920101

KROM RADYATÖR VALFLERİ (Havlupan Tipi Radyatörler İçin)

ÜRÜN	ÜRÜN KODU	ÜRÜN ADI	TEKNİK ÇİZİM	LİSTE FİYATI ₺	ÜRÜN KT. AD.
	602 120 751	1/2" RV3 KROM KÖŞE RADYATÖR VALFİ (Ø16 X 2 mm) - Pex • Sıcak Sulu Isıtma sistemleri, 10bar, 120°C • Krom kaplama		59	50
	602 120 752	1/2" RV3 KROM DÜZ RADYATÖR VALFİ (Ø16 X 2 mm) - Pex • Sıcak Sulu Isıtma sistemleri, 10bar, 120°C • Krom kaplama		64	50
	602 120 280	1/2" KROM, VOLANLI KÖŞE RADYATÖR VALFİ • TS 579 • Sıcak Sulu Isıtma sistemleri, 10bar, 120°C • Krom kaplama		45	50
	602 120 281	1/2" KROM, VOLANLI DÜZ RADYATÖR VALFİ • TS 579 • Sıcak Sulu Isıtma sistemleri, 10bar, 120°C • Krom kaplama		49	50





RADYATÖR GERİ DÖNÜŞ VALFLERİ

ÜRÜN	ÜRÜN KODU	ÜRÜN ADI	TEKNİK ÇİZİM	LİSTE FİYATI ₺	ÜRÜN KT. AD.
	602 120 727	1/2" - GV3 DÜZ RADYATÖR DÖNÜŞ VALFİ Nikel • TS 579 • Sıcak Sulu Isıtma sistemleri, 10bar, 120°C		36	30
	602 120 726	1/2" - GV3 KÖŞE RADYATÖR DÖNÜŞ VALFİ Nikel • TS 579 • Sıcak Sulu Isıtma sistemleri, 10bar, 120°C		35	40
	602 120 731	DÜZ RADYATÖR DÖNÜŞ VALFİ (Ø 16 x 2 mm) - Pex GV3 - GERİ DÖNÜŞ VALFİ • Sıcak Sulu Isıtma sistemleri, 10bar, 120°C		41	30
	602 120 730	KÖŞE RADYATÖR DÖNÜŞ VALFİ (Ø 16 x 2 mm) - Pex GV3 - GERİ DÖNÜŞ VALFİ • Sıcak Sulu Isıtma sistemleri, 10bar, 120°C		37	40



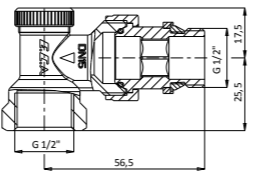

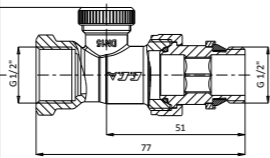

• Fiyatlara KDV ayrıca dahil edilir. Tavsiye edilen bayi satış fiyatıdır.

• Standart belgelerine ve belgelendirme kapsamındaki ürünlere www.eca.com.tr, www.valf.com.tr üzerinden ulaşılabilir.
SİRKÜLER NO: S1920101

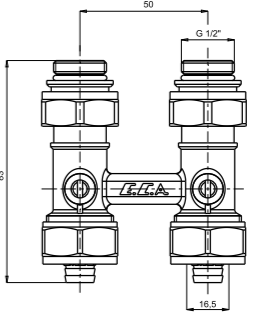
RADYATÖR GERİ DÖNÜŞ VALFLERİ

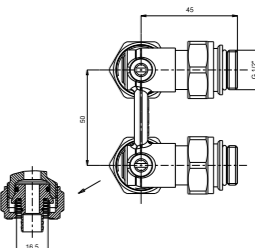
ÜRÜN	ÜRÜN KODU	ÜRÜN ADI	TEKNİK ÇİZİM	LİSTE FİYATI ₺	ÜRÜN KT. AD.
	602 120 728	1/2" GV3 KÖŞE RADYATÖR DÖNÜŞ VALFİ CONTALI • TS 579 • Sıcak Sulu Isıtma sistemleri, 10bar, 120°C		37	40
	602 120 729	1/2" GV3 DÜZ RADYATÖR DÖNÜŞ VALFİ CONTALI • TS 579 • Sıcak Sulu Isıtma sistemleri, 10bar, 120°C		41	30
	602 499 181	1/2" X Ø16 MM RADYATÖR BAĞLANTI DİRSEĞİ • Sıcak Sulu Isıtma sistemleri, 10bar, 120°C		29	20

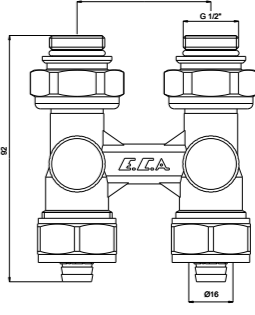
H-VALFLER (kompakt tip panel radyatörler için)

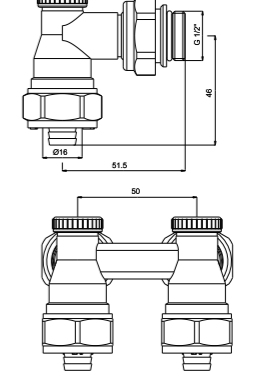
ÜRÜN	ÜRÜN KODU	ÜRÜN ADI	TEKNİK ÇİZİM	LİSTE FİYATI ₺	ÜRÜN KT. AD.
	602 120 331	1/2" X 16 mm KÜRESEL H-VALF, DÜZ TİP PEX BORU BAĞLANTILI • Tornavida kontrollü küre klape • Sıcak Sulu Isıtma sistemleri, 10bar, 120°C		97	7
	602 120 333	1/2" X 16 mm KÜRESEL H-VALF, KÖŞE TİP PEX BORU BAĞLANTILI • Tornavida kontrollü küre klape • Sıcak Sulu Isıtma sistemleri, 10bar, 120°C		101	7
	602 120 348	1/2" X 16 mm H-VALF STOP TİPİ, DÜZ PEX BORU BAĞLANTILI • Allen kontrollü klape • Klape koruma kapağı • Sıcak Sulu Isıtma sistemleri, 10bar, 120°C		109	7
	602 120 349	1/2" X 16 mm H-VALF STOP TİPİ, KÖŞE PEX BORU BAĞLANTILI • Allen kontrollü klape • Klape koruma kapağı • Sıcak Sulu Isıtma sistemleri, 10bar, 120°C		112	7

• Fiyatlara KDV ayrıca dahil edilir. Tavsiye edilen bayi satış fiyatıdır.

• Standart belgelerine ve belgelendirme kapsamındaki ürünlere www.eca.com.tr, www.valf.com.tr üzerinden ulaşılabilir.
SİRKÜLER NO: S1920101

RAKORLAR

ÜRÜN	ÜRÜN KODU	ÜRÜN ADI	LİSTE FİYATI ₺	ÜRÜN KT. AD.
	601 002 001	3/8" KÖŞE RAKOR	23	100
	601 002 002	1/2" KÖŞE RAKOR	23	80
	601 002 003	3/4" KÖŞE RAKOR	33	40
	601 002 004	1" KÖŞE RAKOR	52	25
	601 002 005	1 1/4" KÖŞE RAKOR	96	15
	602 121 001	3/8" KÖŞE RAKOR, NİKEL KAPLAMALI	27	100
	602 121 002	1/2" KÖŞE RAKOR, NİKEL KAPLAMALI	27	80
	602 121 003	3/4" KÖŞE RAKOR, NİKEL KAPLAMALI	43	40
	602 121 004	1" KÖŞE RAKOR, NİKEL KAPLAMALI	68	25
	602 121 005	1 1/4" KÖŞE RAKOR, NİKEL KAPLAMALI	108	15

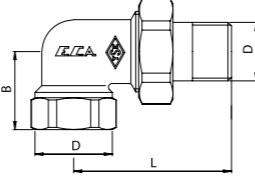



• TS 579
• Sıcak Sulu Isıtma sistemleri, 10 bar, 120°C

Kod. No	D	L	D1
601 002 001	G 3/8"	50	22
601 002 002	1/2"	56	26
601 002 003	3/4"	64	29
601 002 004	G 1"	72	34
601 002 005	G1 1/4"	81.5	42

Kod. No	D	L	D1
602 121 001	G 3/8"	50	22
602 121 002	1/2"	56	26
602 121 003	3/4"	64	29
602 121 004	G 1"	72	34
602 121 005	G1 1/4"	81.5	42

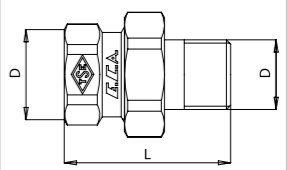
ÜRÜN	ÜRÜN KODU	ÜRÜN ADI	LİSTE FİYATI ₺	ÜRÜN KT. AD.
	601 002 006	3/8" DÜZ RAKOR	19	125
	601 002 007	1/2" DÜZ RAKOR	19	100
	601 002 008	3/4" DÜZ RAKOR	27	70
	601 002 009	1" DÜZ RAKOR	43	40
	601 002 010	1 1/4" DÜZ RAKOR	87	25
	602 121 006	3/8" DÜZ RAKOR, NİKEL KAPLAMALI	19	125
	602 121 007	1/2" DÜZ RAKOR, NİKEL KAPLAMALI	19	100
	602 121 008	3/4" DÜZ RAKOR, NİKEL KAPLAMALI	31	70
	602 121 009	1" DÜZ RAKOR, NİKEL KAPLAMALI	56	40
	602 121 010	1 1/4" DÜZ RAKOR, NİKEL KAPLAMALI	96	25

• TS 579
• Sıcak Sulu Isıtma sistemleri, 10 bar, 120°C





Kod. No	D	L
601 002 006	G 3/8"	50
601 002 007	1/2"	56
601 002 008	3/4"	64
601 002 009	G 1"	72
601 002 010	G1 1/4"	81.5

Kod. No	D	L
602 121 006	G 3/8"	50
602 121 007	1/2"	56
602 121 008	3/4"	64
602 121 009	G 1"	72
602 121 010	G1 1/4"	81.5

• Fiyatlara KDV ayrıca dahil edilir. Tavsiye edilen bayi satış fiyatıdır.

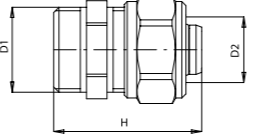

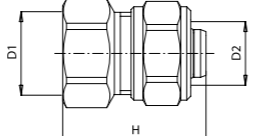
• Standart belgelerine ve belgelendirme kapsamındaki ürünlere www.eca.com.tr, www.valf.com.tr üzerinden ulaşılabilir.
SİRKÜLER NO: S1920101

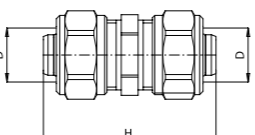
PEX BORU BAĞLANTI ELEMANLARI

ÜRÜN	ÜRÜN KODU	ÜRÜN ADI	TEKNİK ÇİZİM	LİSTE FİYATI ₺	ÜRÜN KT. AD.																			
	602 199 272	1/2" x 16 mm DÜZ RAKOR DIŞ VİDA		16	150																			
		<table border="1"> <thead> <tr> <th>Kod. No</th> <th>D1</th> <th>D2</th> <th>H</th> </tr> </thead> <tbody> <tr> <td>602 199 272</td> <td>1/2"</td> <td>16</td> <td>36.1</td> </tr> <tr> <td>602 199 284</td> <td>1/2"</td> <td>20</td> <td>44</td> </tr> <tr> <td>602 199 275</td> <td>G 3/8"</td> <td>16</td> <td>35.1</td> </tr> <tr> <td>602 199 285</td> <td>G 3/8"</td> <td>20</td> <td>46</td> </tr> </tbody> </table>	Kod. No	D1	D2	H	602 199 272	1/2"	16	36.1	602 199 284	1/2"	20	44	602 199 275	G 3/8"	16	35.1	602 199 285	G 3/8"	20	46		
Kod. No	D1	D2	H																					
602 199 272	1/2"	16	36.1																					
602 199 284	1/2"	20	44																					
602 199 275	G 3/8"	16	35.1																					
602 199 285	G 3/8"	20	46																					
	602 199 273	1/2" x 16 mm DÜZ RAKOR İÇ VİDA		17	200																			
		<table border="1"> <thead> <tr> <th>Kod. No</th> <th>D1</th> <th>D2</th> <th>H</th> </tr> </thead> <tbody> <tr> <td>602 199 273</td> <td>1/2"</td> <td>16</td> <td>36</td> </tr> <tr> <td>602 199 286</td> <td>1/2"</td> <td>20</td> <td>36</td> </tr> <tr> <td>602 199 287</td> <td>3/4"</td> <td>20</td> <td>45</td> </tr> </tbody> </table>	Kod. No	D1	D2	H	602 199 273	1/2"	16	36	602 199 286	1/2"	20	36	602 199 287	3/4"	20	45						
Kod. No	D1	D2	H																					
602 199 273	1/2"	16	36																					
602 199 286	1/2"	20	36																					
602 199 287	3/4"	20	45																					
	602 199 274	16 x 16 mm DÜZ RAKOR PEX BORU BAĞLANTILI		27	150																			
		<table border="1"> <thead> <tr> <th>Kod. No</th> <th>D1</th> <th>D2</th> <th>H</th> </tr> </thead> <tbody> <tr> <td>602 199 274</td> <td>16</td> <td>16</td> <td>51</td> </tr> <tr> <td>602 199 283</td> <td>20</td> <td>20</td> <td>51.2</td> </tr> </tbody> </table>	Kod. No	D1	D2	H	602 199 274	16	16	51	602 199 283	20	20	51.2										
Kod. No	D1	D2	H																					
602 199 274	16	16	51																					
602 199 283	20	20	51.2																					

YERDEN DAĞITIM SİSTEMLERİ

E.C.A. 01 1 1/4" debi ayar vanalı kollektörler, Nikel kaplamalı

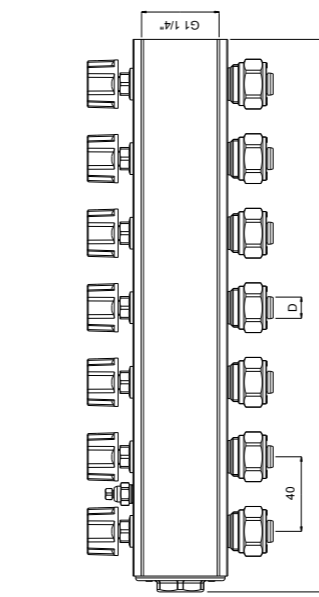
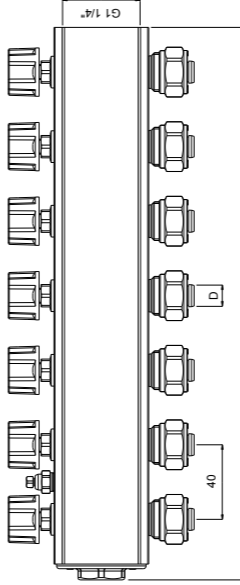
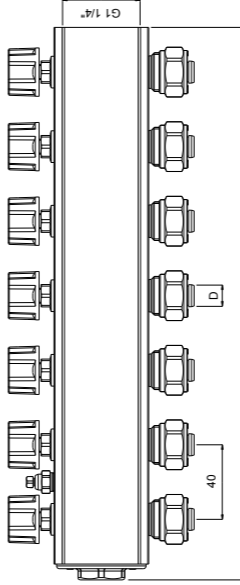
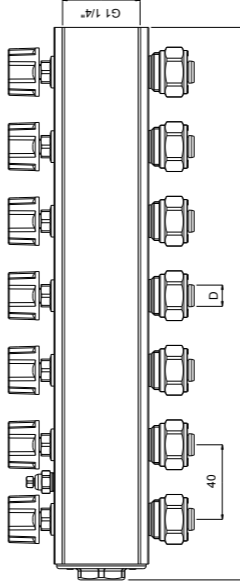
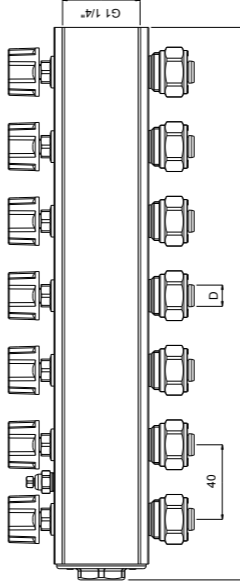
ÜRÜN	ÜRÜN KODU	ÜRÜN ADI	LİSTE FİYATI ₺	ÜRÜN KT. AD.																								
	kırmızı volanlı: 602 120 608 mavi volanlı: 602 120 601	1 1/4" DEBİ AYAR VANALI KOLLEKTÖR, 7 ÇIKIŞLI Ø16 x 2 mm - Pex	433	4																								
	kırmızı volanlı: 602 120 609 mavi volanlı: 602 120 602	1 1/4" DEBİ AYAR VANALI KOLLEKTÖR, 8 ÇIKIŞLI Ø16 x 2 mm - Pex	493	6																								
	kırmızı volanlı: 602 120 610 mavi volanlı: 602 120 603	1 1/4" DEBİ AYAR VANALI KOLLEKTÖR, 9 ÇIKIŞLI Ø16 x 2 mm - Pex	555	6																								
	kırmızı volanlı: 602 120 611 mavi volanlı: 602 120 604	1 1/4" DEBİ AYAR VANALI KOLLEKTÖR, 10 ÇIKIŞLI Ø16 x 2 mm - Pex	617	2																								
	kırmızı volanlı: 602 120 612 mavi volanlı: 602 120 605	1 1/4" DEBİ AYAR VANALI KOLLEKTÖR, 11 ÇIKIŞLI Ø16 x 2 mm - Pex	679	2																								
	kırmızı volanlı: 602 120 613 mavi volanlı: 602 120 606	1 1/4" DEBİ AYAR VANALI KOLLEKTÖR, 12 ÇIKIŞLI Ø16 x 2 mm - Pex	741	2																								
	kırmızı volanlı: 602 120 614 mavi volanlı: 602 120 607	1 1/4" DEBİ AYAR VANALI KOLLEKTÖR, 13 ÇIKIŞLI Ø16 x 2 mm - Pex	800	2																								
		<ul style="list-style-type: none"> TSEK belgeli Sıcak Sulu Isıtma sistemleri, sıhhi tesisatlar 10bar, 120°C Kollektörler üzerinde purjör bulunmaktadır. 																										
		<table border="1"> <thead> <tr> <th>Çıkış</th> <th>D</th> <th>d</th> <th>L</th> <th>B</th> <th>H</th> </tr> </thead> <tbody> <tr> <td>7</td> <td rowspan="7">G 1 1/4"</td> <td rowspan="7">Ø16x2</td> <td>296.5</td> <td rowspan="7">40</td> <td rowspan="7">95</td> </tr> <tr> <td>8</td> <td>336.5</td> </tr> <tr> <td>9</td> <td>376.5</td> </tr> <tr> <td>10</td> <td>416.5</td> </tr> <tr> <td>11</td> <td>456.5</td> </tr> <tr> <td>12</td> <td>496.5</td> </tr> <tr> <td>13</td> <td>536.5</td> </tr> </tbody> </table>	Çıkış	D	d	L	B	H	7	G 1 1/4"	Ø16x2	296.5	40	95	8	336.5	9	376.5	10	416.5	11	456.5	12	496.5	13	536.5		
Çıkış	D	d	L	B	H																							
7	G 1 1/4"	Ø16x2	296.5	40	95																							
8			336.5																									
9			376.5																									
10			416.5																									
11			456.5																									
12			496.5																									
13			536.5																									





* 17x2 mm plastik boru, 15x2 mm boru seçenekleri siparişe özel üretilecek olup ayrıca fiyatlandırılacaktır.

• Fiyatlara KDV ayrıca dahil edilir. Tavsiye edilen bayi satış fiyatıdır.

• Standart belgelerine ve belgelendirme kapsamındaki ürünlere www.eca.com.tr, www.valf.com.tr üzerinden ulaşılabilir. SİRKÜLER NO: S1920101

YERDEN DAĞITIM SİSTEMLERİ

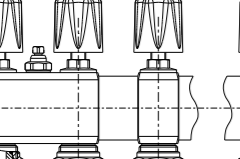
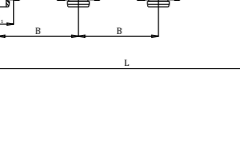
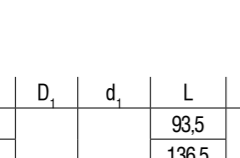
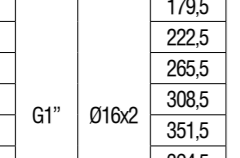
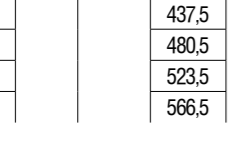
E.C.A. 02 1" debi ayar vanalı kollektörler, Nikel kaplamalı

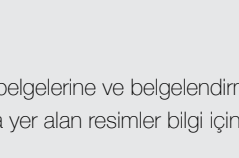
ÜRÜN	ÜRÜN KODU	ÜRÜN ADI	LİSTE FİYATI ₺	ÜRÜN KT. AD.
	kırmızı volanlı: 602 120 695 mavi volanlı: 602 120 694	1" DEBİ AYAR VANALI KOLLEKTÖR, NİKEL, 2 ÇIKIŞLI, Ø16 x 2 mm - Pex	87	5
	kırmızı volanlı: 602 120 680 mavi volanlı: 602 120 669	1" DEBİ AYAR VANALI KOLLEKTÖR, NİKEL 3 ÇIKIŞLI, Ø16 x 2 mm - Pex	121	5
	kırmızı volanlı: 602 120 681 mavi volanlı: 602 120 670	1" DEBİ AYAR VANALI KOLLEKTÖR, NİKEL 4 ÇIKIŞLI, Ø16 x 2 mm - Pex	156	9
	kırmızı volanlı: 602 120 682 mavi volanlı: 602 120 671	1" DEBİ AYAR VANALI KOLLEKTÖR NİKEL 5 ÇIKIŞLI, Ø16 x 2 mm - Pex	181	12
	kırmızı volanlı: 602 120 683 mavi volanlı: 602 120 672	1" DEBİ AYAR VANALI KOLLEKTÖR, NİKEL 6 ÇIKIŞLI, Ø16 x 2 mm - Pex	217	6
	kırmızı volanlı: 602 120 684 mavi volanlı: 602 120 673	1" DEBİ AYAR VANALI KOLLEKTÖR, NİKEL 7 ÇIKIŞLI, Ø16 x 2 mm - Pex	251	6
	kırmızı volanlı: 602 120 685 mavi volanlı: 602 120 674	1" DEBİ AYAR VANALI KOLLEKTÖR, NİKEL 8 ÇIKIŞLI, Ø16 x 2 mm - Pex	287	8
	kırmızı volanlı: 602 120 686 mavi volanlı: 602 120 675	1" DEBİ AYAR VANALI KOLLEKTÖR, NİKEL 9 ÇIKIŞLI, Ø16 x 2 mm - Pex	324	8
	kırmızı volanlı: 602 120 687 mavi volanlı: 602 120 676	1" DEBİ AYAR VANALI KOLLEKTÖR, NİKEL 10 ÇIKIŞLI, Ø16 x 2 mm - Pex	360	4
	kırmızı volanlı: 602 120 688 mavi volanlı: 602 120 677	1" DEBİ AYAR VANALI KOLLEKTÖR, NİKEL 11 ÇIKIŞLI, Ø16 x 2 mm - Pex	394	4
	kırmızı volanlı: 602 120 689 mavi volanlı: 602 120 678	1" DEBİ AYAR VANALI KOLLEKTÖR, NİKEL 12 ÇIKIŞLI, Ø16 x 2 mm - Pex	432	4
	kırmızı volanlı: 602 120 690 mavi volanlı: 602 120 679	1" DEBİ AYAR VANALI KOLLEKTÖR, NİKEL 13 ÇIKIŞLI, Ø16 x 2 mm - Pex	467	4

Çıkış	D ₁	d ₁	L	B	H
2			93,5		
3			136,5		
4			179,5		
5			222,5		
6			265,5		
7			308,5		
8			351,5		
9			394,5		
10			437,5		
11			480,5		
12			523,5		
13			566,5		

Çıkış	D ₁	d ₁	L	B	H
2	G1"	Ø16x2	93,5	43	98,5
3	G1"	Ø16x2	136,5	43	98,5
4	G1"	Ø16x2	179,5	43	98,5
5	G1"	Ø16x2	222,5	43	98,5
6	G1"	Ø16x2	265,5	43	98,5
7	G1"	Ø16x2	308,5	43	98,5
8	G1"	Ø16x2	351,5	43	98,5
9	G1"	Ø16x2	394,5	43	98,5
10	G1"	Ø16x2	437,5	43	98,5
11	G1"	Ø16x2	480,5	43	98,5
12	G1"	Ø16x2	523,5	43	98,5
13	G1"	Ø16x2	566,5	43	98,5

- TSEK belgeli
- Sıcak Sulu Isıtma sistemleri, 10bar, 120°C
- Kollektörler üzerinde purjör bulunmaktadır.

Sihhi Tesisatlarda

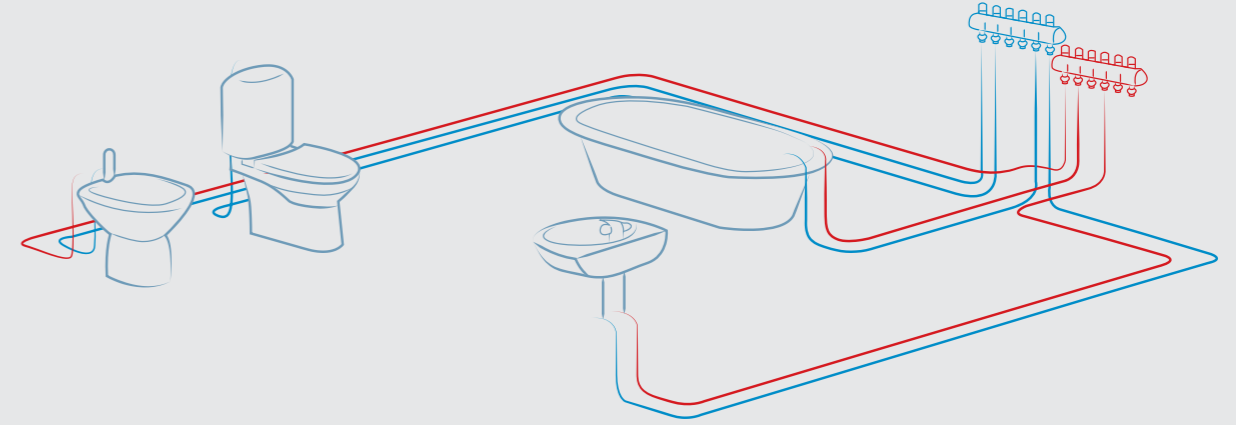

Radyatörlü Isıtma Sistemlerinde Kullanımı;

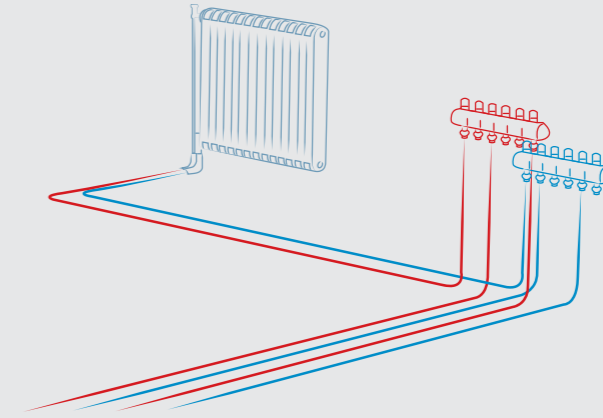

Yerden Isıtma Sistemlerinde Kullanımı;

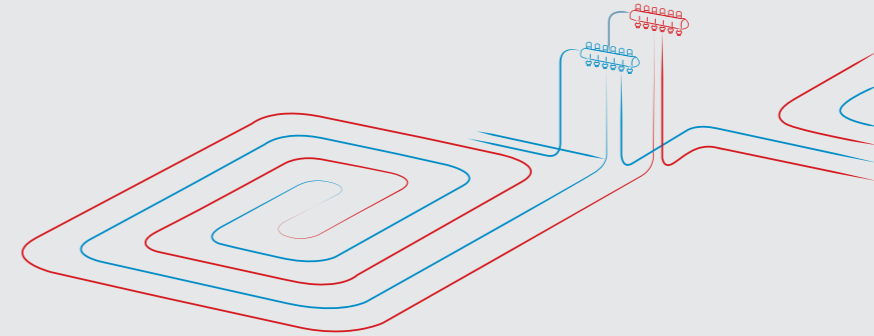





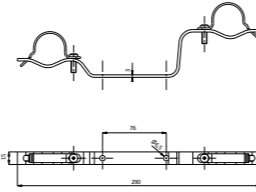

• Fiyatlara KDV ayrıca dahil edilir. Tavsiye edilen bayi satış fiyatıdır.

• Standart belgelerine ve belgelendirme kapsamındaki ürünlere www.eca.com.tr, www.valf.com.tr üzerinden ulaşılabilir. SİRKÜLER NO: S1920101

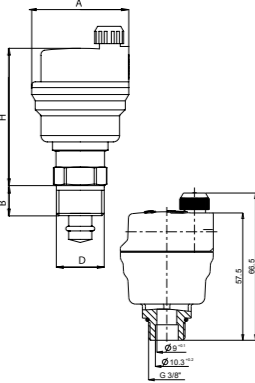
KOLLEKTÖR BAĞLANTI ELEMANLARI

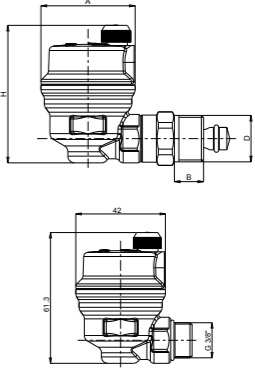
ÜRÜN	ÜRÜN KODU	ÜRÜN ADI	TEKNİK ÇİZİM	LİSTE FİYATI ₺	ÜRÜN KT. AD.
	610 212 001	KELEPÇELİ 1" KOLLEKTÖR KONSOLU İKİLİ SET (E.C.A. 02 TİPİ İÇİN) • Duvar sabitleme vidaları hariçtir.		22	10

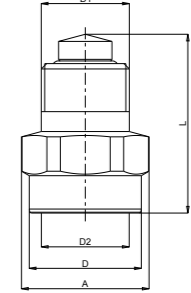
OTOMATİK HAVALANDIRICI VE PURJÖRLER

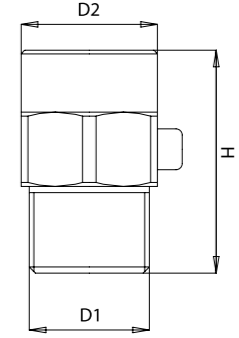

ÜRÜN	ÜRÜN KODU	ÜRÜN ADI	TEKNİK ÇİZİM	LİSTE FİYATI ₺	ÜRÜN KT. AD.
	102 109 139	3/8" OTOMATİK HAVALANDIRICI (Çekvalfli)		75	40
	102 109 134	1/2" OTOMATİK HAVALANDIRICI (Çekvalfli)		77	40
	602 109 013	3/8" OTOMATİK HAVALANDIRICI (Çekvalfsiz) TS 7817 • Sıcak Sulu Isıtma Sistemleri, 10bar, 110°C		63	40
	602 109 033	3/8" OTOMATİK HAVALANDIRICI - KÖŞE (Çekvalfli)		80	45
	602 109 034	1/2" OTOMATİK HAVALANDIRICI - KÖŞE (Çekvalfli)		81	45
	602 109 037	3/8" OTOMATİK HAVALANDIRICI - KÖŞE (Çekvalfsiz) • TS 7817 • Sıcak Sulu Isıtma Sistemleri, 10bar, 110°C		67	45
	102 199 150-01	3/8" OTOMATİK PURJÖR ÇEKVALFI		13,20	60
	102 199 154-01	1/2" OTOMATİK PURJÖR ÇEKVALFI		14	60
	102 109 011	1/8" E.C.A. STANDART PURJÖR		19,20	50
	102 109 012	1/4" E.C.A. STANDART PURJÖR		19,20	50
	110 721 089	E.C.A. PURJÖR ANAHTARI		4,60	50

• Fiyatlara KDV ayrıca dahil edilir. Tavsiye edilen bayi satış fiyatıdır.

• Standart belgelerine ve belgelendirme kapsamındaki ürünlere www.eca.com.tr, www.valf.com.tr üzerinden ulaşılabilir.
SİRKÜLER NO: S1920101

EMNİYET VALFLERİ

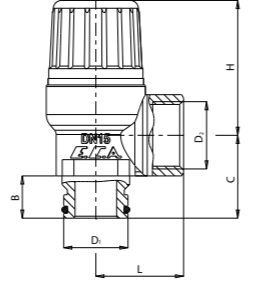
GÜNEŞ ENERJİSİ SİSTEMLERİ EMNİYET VALFİ



ÜRÜN	ÜRÜN KODU	ÜRÜN ADI	TEKNİK ÇİZİM	LİSTE FİYATI ₺	ÜRÜN KT. AD.												
	602 111 033	GÜNEŞ ENERJİSİ EMNİYET VALFİ - Ø20 O-RİNGLİ 1/2" İÇ VİDA		35	50												
		<table border="1"> <tr> <td>D1</td> <td>D2</td> <td>B</td> <td>L</td> <td>C</td> <td>H</td> </tr> <tr> <td>Ø20</td> <td>1/2"</td> <td>13</td> <td>27</td> <td>25,5</td> <td>41,5</td> </tr> </table>		D1	D2	B	L	C	H	Ø20	1/2"	13	27	25,5	41,5		
D1	D2	B		L	C	H											
Ø20	1/2"	13	27	25,5	41,5												
	602 111 034	GÜNEŞ ENERJİSİ EMNİYET VALFİ, 1/2" İÇ/DIŞ VİDA	35	50													
		<table border="1"> <tr> <td>D1</td> <td>D2</td> <td>B</td> <td>L</td> <td>C</td> <td>H</td> </tr> <tr> <td>1/2"</td> <td>1/2"</td> <td>13</td> <td>27</td> <td>25,5</td> <td>41,5</td> </tr> </table>	D1	D2	B	L	C	H	1/2"	1/2"	13	27	25,5	41,5			
D1	D2	B	L	C	H												
1/2"	1/2"	13	27	25,5	41,5												
	602 111 035	GÜNEŞ ENERJİSİ EMNİYET VALFİ, 1/2" İÇ VİDA	35	50													
		<ul style="list-style-type: none"> • TS EN 4126-1 • 3 bar ayar basıncı • 110°C Sıcak Su <table border="1"> <tr> <td>D1</td> <td>D2</td> <td>L</td> <td>C</td> <td>H</td> </tr> <tr> <td>1/2"</td> <td>1/2"</td> <td>27</td> <td>25,5</td> <td>41,5</td> </tr> </table>	D1	D2	L	C	H	1/2"	1/2"	27	25,5	41,5					
D1	D2	L	C	H													
1/2"	1/2"	27	25,5	41,5													

DOĞALGAZ KÜRESEL VALFLERİ - MOP 0.5

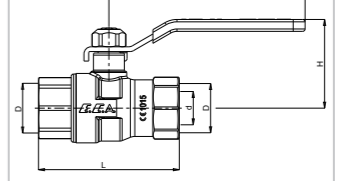
(Bina İçi Doğalgaz Tesisatları için)

ÜRÜN	ÜRÜN KODU	ÜRÜN ADI	TEKNİK ÇİZİM	LİSTE FİYATI ₺	ÜRÜN KT. AD.																																									
	602 122 151	1/2" DOĞALGAZ KÜRESEL VALFİ		32	24																																									
	602 122 152	3/4" DOĞALGAZ KÜRESEL VALFİ		39	12																																									
	602 122 153	1" DOĞALGAZ KÜRESEL VALFİ		63	15																																									
	602 122 154	1 1/4" DOĞALGAZ KÜRESEL VALFİ		139	8																																									
	602 122 155	1 1/2" DOĞALGAZ KÜRESEL VALFİ		185	6																																									
	602 122 156	2" DOĞALGAZ KÜRESEL VALFİ		284	3																																									
		<ul style="list-style-type: none"> • EN331 Sistem 1'e göre 650°C - 30 dk. özel performans testinden başarı ile geçerek CE belgelidir. • Bina içi doğalgaz tesisatlarında kullanımı uygundur. <table border="1"> <tr> <td>Kod. No</td> <td>D</td> <td>d</td> <td>L</td> <td>A</td> <td>H</td> </tr> <tr> <td>602 122 151</td> <td>Rp 1/2"</td> <td>14</td> <td>59,2</td> <td>82,5</td> <td>37,3</td> </tr> <tr> <td>602 122 152</td> <td>Rp 3/4"</td> <td>19</td> <td>68,2</td> <td>82,5</td> <td>40,7</td> </tr> <tr> <td>602 122 153</td> <td>Rp 1"</td> <td>24</td> <td>83</td> <td>100</td> <td>47,5</td> </tr> <tr> <td>602 122 154</td> <td>Rp 1 1/4"</td> <td>30</td> <td>97</td> <td>154,5</td> <td>64,3</td> </tr> <tr> <td>602 122 155</td> <td>Rp 1 1/2"</td> <td>38</td> <td>103</td> <td>154,5</td> <td>69,3</td> </tr> <tr> <td>602 122 156</td> <td>Rp 2"</td> <td>47</td> <td>127</td> <td>185</td> <td>79,5</td> </tr> </table>	Kod. No	D	d	L	A	H	602 122 151	Rp 1/2"	14	59,2	82,5	37,3	602 122 152	Rp 3/4"	19	68,2	82,5	40,7	602 122 153	Rp 1"	24	83	100	47,5	602 122 154	Rp 1 1/4"	30	97	154,5	64,3	602 122 155	Rp 1 1/2"	38	103	154,5	69,3	602 122 156	Rp 2"	47	127	185	79,5		
Kod. No	D	d	L	A	H																																									
602 122 151	Rp 1/2"	14	59,2	82,5	37,3																																									
602 122 152	Rp 3/4"	19	68,2	82,5	40,7																																									
602 122 153	Rp 1"	24	83	100	47,5																																									
602 122 154	Rp 1 1/4"	30	97	154,5	64,3																																									
602 122 155	Rp 1 1/2"	38	103	154,5	69,3																																									
602 122 156	Rp 2"	47	127	185	79,5																																									
		CE																																												

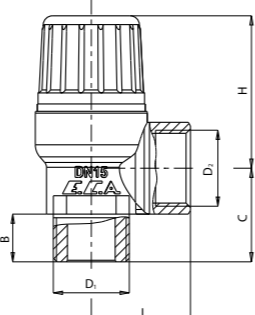
SU TESİSAT/KOMBİ EMNİYET VALFİ

ÜRÜN	ÜRÜN KODU	ÜRÜN ADI	TEKNİK ÇİZİM	LİSTE FİYATI ₺	ÜRÜN KT. AD.											
	602 111 031	KOMBİ EMNİYET VALFİ, 1/2" İÇ/DIŞ VİDA		35	50											
		<table border="1"> <tr> <td>D1</td> <td>D2</td> <td>B</td> <td>L</td> <td>C</td> <td>H</td> </tr> <tr> <td>1/2"</td> <td>1/2"</td> <td>13</td> <td>27</td> <td>25,5</td> <td>41,5</td> </tr> </table>		D1	D2	B	L	C	H	1/2"	1/2"	13	27	25,5	41,5	
D1	D2	B	L	C	H											
1/2"	1/2"	13	27	25,5	41,5											
	602 111 032	KOMBİ EMNİYET VALFİ, 1/2" İÇ VİDA	35	50												
		<ul style="list-style-type: none"> • TS EN 4126-1 • 3 bar ayar basıncı • 110°C Sıcak Su <table border="1"> <tr> <td>D1</td> <td>D2</td> <td>L</td> <td>C</td> <td>H</td> </tr> <tr> <td>1/2"</td> <td>1/2"</td> <td>27</td> <td>25,5</td> <td>41,5</td> </tr> </table>	D1	D2	L	C	H	1/2"	1/2"	27	25,5	41,5				
D1	D2	L	C	H												
1/2"	1/2"	27	25,5	41,5												

KİLİTLEMELİ DOĞALGAZ KÜRESEL VALFLERİ - MOP 0.5

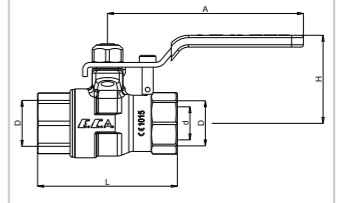

(Bina İçi Doğalgaz Tesisatları için)

ÜRÜN	ÜRÜN KODU	ÜRÜN ADI	TEKNİK ÇİZİM	LİSTE FİYATI ₺	ÜRÜN KT. AD.																							
	602 122 175	1/2" KİLİTLEMELİ DOĞALGAZ KÜRESEL VALF		35	24																							
	602 122 176	3/4" KİLİTLEMELİ DOĞALGAZ KÜRESEL VALF		44	12																							
	602 122 177	1" KİLİTLEMELİ DOĞALGAZ KÜRESEL VALF		71	15																							
		<ul style="list-style-type: none"> • EN331 Sistem 1'e göre 650°C - 30 dk. özel performans testinden başarı ile geçerek CE belgelidir. • Bina içi doğalgaz tesisatlarında kullanımı uygundur. <table border="1"> <tr> <td>Kod. No</td> <td>D</td> <td>d</td> <td>L</td> <td>A</td> <td>H</td> </tr> <tr> <td>602 122 175</td> <td>Rp 1/2"</td> <td>14</td> <td>59,2</td> <td>83</td> <td>37,3</td> </tr> <tr> <td>602 122 176</td> <td>Rp 3/4"</td> <td>19</td> <td>68,2</td> <td>83</td> <td>40,7</td> </tr> <tr> <td>602 122 177</td> <td>Rp 1"</td> <td>24</td> <td>83</td> <td>100</td> <td>47,5</td> </tr> </table>	Kod. No	D	d	L	A	H	602 122 175	Rp 1/2"	14	59,2	83	37,3	602 122 176	Rp 3/4"	19	68,2	83	40,7	602 122 177	Rp 1"	24	83	100	47,5		
Kod. No	D	d	L	A	H																							
602 122 175	Rp 1/2"	14	59,2	83	37,3																							
602 122 176	Rp 3/4"	19	68,2	83	40,7																							
602 122 177	Rp 1"	24	83	100	47,5																							
		CE																										

• Fiyatlara KDV ayrıca dahil edilir. Tavsiye edilen bayi satış fiyatıdır.

• Standart belgelerine ve belgelendirme kapsamındaki ürünlere www.eca.com.tr, www.valf.com.tr üzerinden ulaşılabilir. SİRKÜLER NO: S1920101

DOĞALGAZ KÜRESEL VALFLERİ - MOP 5 (Bina Dışı Doğalgaz Tesisatları için)

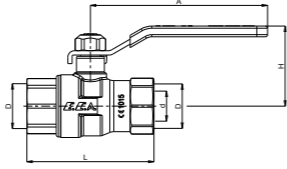
ÜRÜN	ÜRÜN KODU	ÜRÜN ADI	TEKNİK ÇİZİM	LİSTE FİYATI ₺	ÜRÜN KT. AD.																																										
 	602 122 205	1/2" DOĞALGAZ KÜRESEL VALFİ		31	24																																										
	602 122 206	3/4" DOĞALGAZ KÜRESEL VALFİ		37	12																																										
	602 122 207	1" DOĞALGAZ KÜRESEL VALFİ		61	15																																										
	602 122 208	1 1/4" DOĞALGAZ KÜRESEL VALFİ		135	8																																										
	602 122 209	1 1/2" DOĞALGAZ KÜRESEL VALFİ		180	6																																										
	602 122 210	2" DOĞALGAZ KÜRESEL VALFİ		276	3																																										
		<ul style="list-style-type: none"> EN331 Sistem 3'e göre CE belgelidir. Bina dışı doğalgaz tesisatlarında kullanımı uygundur. 																																													
		<table border="1"> <thead> <tr> <th>Kod. No</th> <th>D</th> <th>d</th> <th>L</th> <th>A</th> <th>H</th> </tr> </thead> <tbody> <tr> <td>602 122 205</td> <td>Rp 1/2"</td> <td>14</td> <td>59.2</td> <td>82.5</td> <td>37.3</td> </tr> <tr> <td>602 122 206</td> <td>Rp 3/4"</td> <td>19</td> <td>68.2</td> <td>82.5</td> <td>40.7</td> </tr> <tr> <td>602 122 207</td> <td>Rp 1"</td> <td>24</td> <td>83</td> <td>100</td> <td>47.5</td> </tr> <tr> <td>602 122 208</td> <td>Rp1 1/4"</td> <td>30</td> <td>97</td> <td>154.5</td> <td>64.3</td> </tr> <tr> <td>602 122 209</td> <td>Rp1 1/2"</td> <td>38</td> <td>103</td> <td>154.5</td> <td>69.3</td> </tr> <tr> <td>602 122 210</td> <td>Rp 2"</td> <td>47</td> <td>127</td> <td>185</td> <td>79.5</td> </tr> </tbody> </table>	Kod. No	D	d	L	A	H	602 122 205	Rp 1/2"	14	59.2	82.5	37.3	602 122 206	Rp 3/4"	19	68.2	82.5	40.7	602 122 207	Rp 1"	24	83	100	47.5	602 122 208	Rp1 1/4"	30	97	154.5	64.3	602 122 209	Rp1 1/2"	38	103	154.5	69.3	602 122 210	Rp 2"	47	127	185	79.5			
Kod. No	D	d	L	A	H																																										
602 122 205	Rp 1/2"	14	59.2	82.5	37.3																																										
602 122 206	Rp 3/4"	19	68.2	82.5	40.7																																										
602 122 207	Rp 1"	24	83	100	47.5																																										
602 122 208	Rp1 1/4"	30	97	154.5	64.3																																										
602 122 209	Rp1 1/2"	38	103	154.5	69.3																																										
602 122 210	Rp 2"	47	127	185	79.5																																										

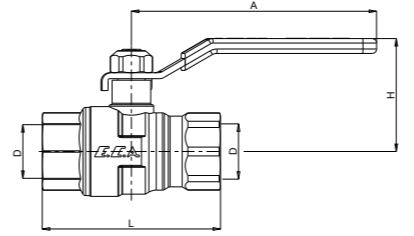

İÇME SUYU KÜRESEL VALFLERİ - PN10

ÜRÜN	ÜRÜN KODU	ÜRÜN ADI	LİSTE FİYATI ₺	ÜRÜN KT. AD.																																											
 	602 122 168	1/2" İÇME SUYU KÜRESEL VALFİ İÇ VE İÇ VİDA - TAM GEÇİŞLİ	32	24																																											
	602 122 169	3/4" İÇME SUYU KÜRESEL VALFİ İÇ VE İÇ VİDA - TAM GEÇİŞLİ	43	12																																											
	602 122 170	1" İÇME SUYU KÜRESEL VALFİ İÇ VE İÇ VİDA - TAM GEÇİŞLİ	69	15																																											
	602 122 182	1 1/4" İÇME SUYU KÜRESEL VALFİ İÇ VE İÇ VİDA - TAM GEÇİŞLİ	161	8																																											
	602 122 183	1 1/2" İÇME SUYU KÜRESEL VALFİ İÇ VE İÇ VİDA - TAM GEÇİŞLİ	215	6																																											
	602 122 184	2" İÇME SUYU KÜRESEL VALFİ İÇ VE İÇ VİDA - TAM GEÇİŞLİ	339	3																																											
		<ul style="list-style-type: none"> TS EN 13828 Çalışma sıcaklık Aralığı: -30°C +80°C 																																													
		<table border="1"> <thead> <tr> <th>Kod. No</th> <th>D</th> <th>d</th> <th>L</th> <th>A</th> <th>H</th> </tr> </thead> <tbody> <tr> <td>602 122 168</td> <td>Rp 1/2"</td> <td>Ø15</td> <td>60</td> <td>83</td> <td>38</td> </tr> <tr> <td>602 122 169</td> <td>Rp 3/4"</td> <td>Ø20</td> <td>68.5</td> <td>83</td> <td>41.2</td> </tr> <tr> <td>602 122 170</td> <td>Rp 1"</td> <td>Ø25</td> <td>83</td> <td>100</td> <td>47.5</td> </tr> <tr> <td>602 122 182</td> <td>Rp1 1/4"</td> <td>Ø32</td> <td>96.1</td> <td>154.5</td> <td>64.3</td> </tr> <tr> <td>602 122 183</td> <td>Rp1 1/2"</td> <td>Ø40</td> <td>109</td> <td>154.5</td> <td>71.25</td> </tr> <tr> <td>602 122 184</td> <td>Rp 2"</td> <td>Ø50</td> <td>129</td> <td>185</td> <td>81.65</td> </tr> </tbody> </table>	Kod. No	D	d	L	A	H	602 122 168	Rp 1/2"	Ø15	60	83	38	602 122 169	Rp 3/4"	Ø20	68.5	83	41.2	602 122 170	Rp 1"	Ø25	83	100	47.5	602 122 182	Rp1 1/4"	Ø32	96.1	154.5	64.3	602 122 183	Rp1 1/2"	Ø40	109	154.5	71.25	602 122 184	Rp 2"	Ø50	129	185	81.65			
Kod. No	D	d	L	A	H																																										
602 122 168	Rp 1/2"	Ø15	60	83	38																																										
602 122 169	Rp 3/4"	Ø20	68.5	83	41.2																																										
602 122 170	Rp 1"	Ø25	83	100	47.5																																										
602 122 182	Rp1 1/4"	Ø32	96.1	154.5	64.3																																										
602 122 183	Rp1 1/2"	Ø40	109	154.5	71.25																																										
602 122 184	Rp 2"	Ø50	129	185	81.65																																										

• Fiyatlara KDV ayrıca dahil edilir. Tavsiye edilen bayi satış fiyatıdır.

• Standart belgelerine ve belgelendirme kapsamındaki ürünlere www.eca.com.tr, www.valf.com.tr üzerinden ulaşılabilir.
SİRKÜLER NO: S1920101

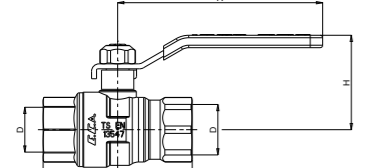
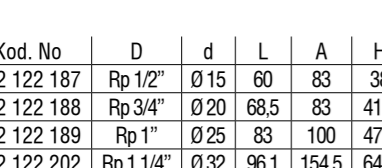
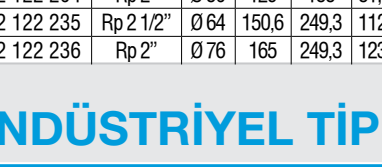
ENDÜSTRİYEL TİP KÜRESEL VALFLER-PN25

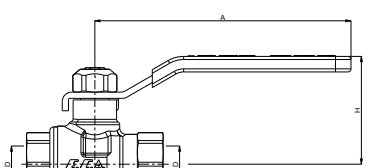
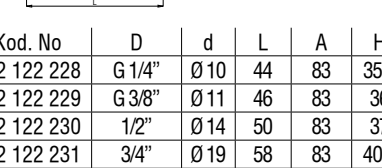
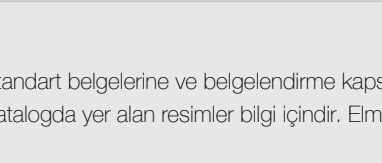
ÜRÜN	ÜRÜN KODU	ÜRÜN ADI	LİSTE FİYATI ₺	ÜRÜN KT. AD.
	602 122 187	1/2" ENDÜSTRİYEL TİP KÜRESEL VALF İÇ VE İÇ VİDA - TAM GEÇİŞLİ	43	24
	602 122 188	3/4" ENDÜSTRİYEL TİP KÜRESEL VALF İÇ VE İÇ VİDA - TAM GEÇİŞLİ	52	12
	602 122 189	1" ENDÜSTRİYEL TİP KÜRESEL VALF İÇ VE İÇ VİDA - TAM GEÇİŞLİ	81	15
	602 122 202	1 1/4" ENDÜSTRİYEL TİP KÜRESEL VALF İÇ VE İÇ VİDA - TAM GEÇİŞLİ	175	8
	602 122 203	1 1/2" ENDÜSTRİYEL TİP KÜRESEL VALF İÇ VE İÇ VİDA - TAM GEÇİŞLİ	228	6
	602 122 204	2" ENDÜSTRİYEL TİP KÜRESEL VALF İÇ VE İÇ VİDA - TAM GEÇİŞLİ	401	3
	602 122 235	2 1/2" ENDÜSTRİYEL TİP KÜRESEL VALF İÇ VE İÇ VİDA - TAM GEÇİŞLİ	1.032	2
	602 122 236	3" ENDÜSTRİYEL TİP KÜRESEL VALF İÇ VE İÇ VİDA - TAM GEÇİŞLİ	1.727	1

Kod. No	D	d	L	A	H
602 122 187	Rp 1/2"	Ø 15	60	83	38
602 122 188	Rp 3/4"	Ø 20	68,5	83	41,2
602 122 189	Rp 1"	Ø 25	83	100	47,5
602 122 202	Rp 1 1/4"	Ø 32	96,1	154,5	64,3
602 122 203	Rp 1 1/2"	Ø 40	109	154,5	71,25
602 122 204	Rp 2"	Ø 50	129	185	81,65
602 122 235	Rp 2 1/2"	Ø 64	150,6	249,3	112,8
602 122 236	Rp 2"	Ø 76	165	249,3	123,8

• TS CEN TS 13547
• Çalışma sıcaklık Aralığı: -30°C +80°C



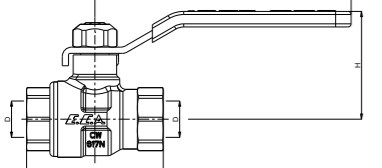
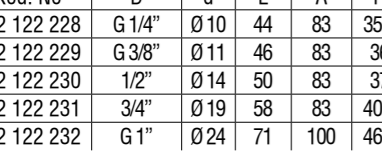
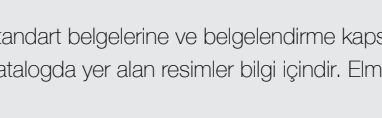

ENDÜSTRİYEL TİP KÜRESEL VALFLER-PN40

ÜRÜN	ÜRÜN KODU	ÜRÜN ADI	LİSTE FİYATI ₺	ÜRÜN KT. AD.
	602 122 228	1/4" ENDÜSTRİYEL TİP KÜRESEL VALF İÇ VE İÇ VİDA - TAM GEÇİŞLİ	52	24
	602 122 229	3/8" ENDÜSTRİYEL TİP KÜRESEL VALF İÇ VE İÇ VİDA - TAM GEÇİŞLİ	52	24
	602 122 230	1/2" ENDÜSTRİYEL TİP KÜRESEL VALF İÇ VE İÇ VİDA - TAM GEÇİŞLİ	53	24
	602 122 231	3/4" ENDÜSTRİYEL TİP KÜRESEL VALF İÇ VE İÇ VİDA - TAM GEÇİŞLİ	67	12
	602 122 232	1" ENDÜSTRİYEL TİP KÜRESEL VALF İÇ VE İÇ VİDA - TAM GEÇİŞLİ	103	15

Kod. No	D	d	L	A	H
602 122 228	G 1/4"	Ø 10	44	83	35,3
602 122 229	G 3/8"	Ø 11	46	83	36
602 122 230	1/2"	Ø 14	50	83	37
602 122 231	3/4"	Ø 19	58	83	40,5
602 122 232	G 1"	Ø 24	71	100	46,5

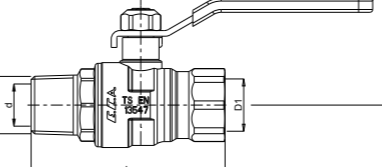
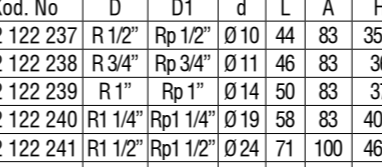
• TS CEN TS 13547
• Çalışma sıcaklık Aralığı: -30°C +80°C

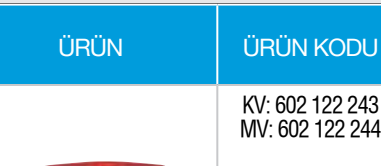





ENDÜSTRİYEL TİP KÜRESEL VALFLER-PN25

ÜRÜN	ÜRÜN KODU	ÜRÜN ADI	LİSTE FİYATI ₺	ÜRÜN KT. AD.
	602 122 237	1/2" ENDÜSTRİYEL TİP KÜRESEL VALF İÇ VE DIŞ VİDA - TAM GEÇİŞLİ	44	24
	602 122 238	3/4" ENDÜSTRİYEL TİP KÜRESEL VALF İÇ VE DIŞ VİDA - TAM GEÇİŞLİ	55	12
	602 122 239	1" ENDÜSTRİYEL TİP KÜRESEL VALF İÇ VE DIŞ VİDA - TAM GEÇİŞLİ	83	15
	602 122 240	1 1/4" ENDÜSTRİYEL TİP KÜRESEL VALF İÇ VE DIŞ VİDA - TAM GEÇİŞLİ	181	8
	602 122 241	1 1/2" ENDÜSTRİYEL TİP KÜRESEL VALF İÇ VE DIŞ VİDA - TAM GEÇİŞLİ	236	6
	602 122 242	2" ENDÜSTRİYEL TİP KÜRESEL VALF İÇ VE DIŞ VİDA - TAM GEÇİŞLİ	420	3

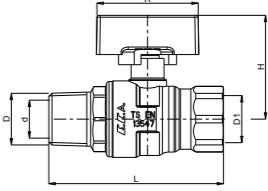
Kod. No	D	D1	d	L	A	H
602 122 237	R 1/2"	Rp 1/2"	Ø 10	44	83	35,3
602 122 238	R 3/4"	Rp 3/4"	Ø 11	46	83	36
602 122 239	R 1"	Rp 1"	Ø 14	50	83	37
602 122 240	R 1 1/4"	Rp 1 1/4"	Ø 19	58	83	40,5
602 122 241	R 1 1/2"	Rp 1 1/2"	Ø 24	71	100	46,5
602 122 242	R 2"	Rp 2"	Ø 24	71	100	46,5

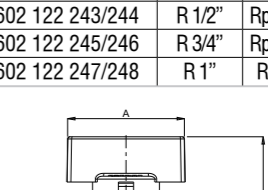
• TS CEN TS 13547
• Çalışma sıcaklık Aralığı: -30°C +80°C

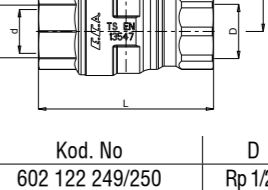
ENDÜSTRİYEL TİP KÜRESEL VALFLER - PN25

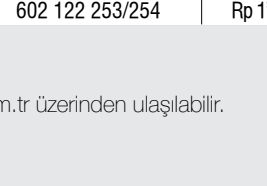
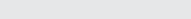
ÜRÜN	ÜRÜN KODU	ÜRÜN ADI	TEKNİK ÇİZİM	LİSTE FİYATI ₺	ÜRÜN KT. AD.
	KV: 602 122 243 MV: 602 122 244	1/2" ENDÜSTRİYEL TİP KÜRESEL VALF İÇ VE DIŞ VİDA - TAM GEÇİŞLİ *		44	24
	KV: 602 122 245 MV: 602 122 246	3/4" ENDÜSTRİYEL TİP KÜRESEL VALF İÇ VE DIŞ VİDA - TAM GEÇİŞLİ		55	12
	KV: 602 122 247 MV: 602 122 248	1" ENDÜSTRİYEL TİP KÜRESEL VALF İÇ VE DIŞ VİDA - TAM GEÇİŞLİ		83	15
	KV: 602 122 249 MV: 602 122 250	1/2" ENDÜSTRİYEL TİP KÜRESEL VALF KELEBEK VOLANLI İÇ VE İÇ VİDA - TAM GEÇİŞLİ*		43	24
	KV: 602 122 251 MV: 602 122 252	3/4" ENDÜSTRİYEL TİP KÜRESEL VALF KELEBEK VOLANLI İÇ VE İÇ VİDA - TAM GEÇİŞLİ		52	12
	KV: 602 122 253 MV: 602 122 254	1" ENDÜSTRİYEL TİP KÜRESEL VALF KELEBEK VOLANLI İÇ VE İÇ VİDA - TAM GEÇİŞLİ		81	15

Kod. No	D	D1	d	L	A	H
602 122 243/244	R 1/2"	Rp 1/2"	Ø 15	69	40	41
602 122 245/246	R 3/4"	Rp 3/4"	Ø 20	77,5	60	48,7
602 122 247/248	R 1"	Rp 1"	Ø 25	93	60	53

Kod. No	D	d	L	A	H
602 122 249/250	Rp 1/2"	Ø 15	60	40	41
602 122 251/252	Rp 3/4"	Ø 20	68,5	60	48,7
602 122 253/254	Rp 1"	Ø 25	83	60	53





• TS CEN TS 13547
• Çalışma sıcaklık Aralığı: -30°C +80°C
• 1/2"-3/4" özel plastik, 1" alüminyum volanlıdır.

KV: Kırmızı Volan MV: Mavi Volan * G1/2" ölçülü ürünler plastik volanlıdır.



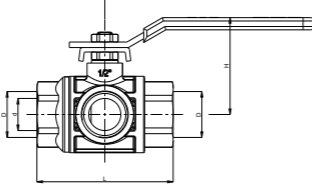

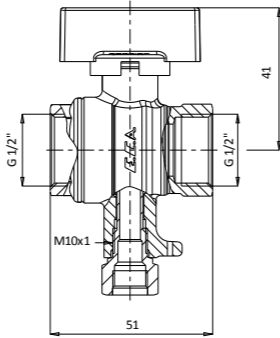
• Fiyatlara KDV ayrıca dahil edilir. Tavsiye edilen bayi satış fiyatıdır.

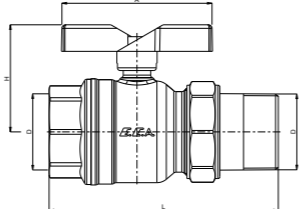
• Standart belgelerine ve belgelendirme kapsamındaki ürünlere www.eca.com.tr, www.valf.com.tr üzerinden ulaşılabilir. SİRKÜLER NO: S1920101

ÖZEL AMAÇLI KÜRESEL VALFLER (SU, YAĞ VE YANICI OLMAYAN GAZLAR İÇİN)

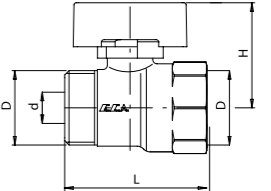
ÜRÜN	ÜRÜN KODU	ÜRÜN ADI	TEKNİK ÇİZİM	LİSTE FİYATI ₺	ÜRÜN KT. AD.																																			
	102 122 131	1/4" ÜÇ YOLLU KÜRESEL VALF		84	24																																			
	102 122 132	3/8" ÜÇ YOLLU KÜRESEL VALF		95	24																																			
	102 122 133	1/2" ÜÇ YOLLU KÜRESEL VALF		133	20																																			
	102 122 134	3/4" ÜÇ YOLLU KÜRESEL VALF		181	10																																			
	102 122 135	1" ÜÇ YOLLU KÜRESEL VALF		272	15																																			
		<ul style="list-style-type: none"> Tam geçişli PN25 Hat ayırma amaçlı kullanılır 180° çevirme kolu hareketi 3 konumlu akış <table border="1"> <thead> <tr> <th>Kod. No</th> <th>D</th> <th>d</th> <th>L</th> <th>A</th> <th>H</th> </tr> </thead> <tbody> <tr> <td>102 122 131</td> <td>G 1/4"</td> <td>10</td> <td>50</td> <td>95</td> <td>41,3</td> </tr> <tr> <td>102 122 132</td> <td>G 3/8"</td> <td>11</td> <td>52</td> <td>95</td> <td>42,2</td> </tr> <tr> <td>102 122 133</td> <td>1/2"</td> <td>14,5</td> <td>62</td> <td>95</td> <td>44,1</td> </tr> <tr> <td>102 122 134</td> <td>3/4"</td> <td>19</td> <td>71</td> <td>115</td> <td>52,7</td> </tr> <tr> <td>102 122 135</td> <td>G 1"</td> <td>24</td> <td>83</td> <td>115</td> <td>56,7</td> </tr> </tbody> </table>	Kod. No	D	d	L	A	H	102 122 131	G 1/4"	10	50	95	41,3	102 122 132	G 3/8"	11	52	95	42,2	102 122 133	1/2"	14,5	62	95	44,1	102 122 134	3/4"	19	71	115	52,7	102 122 135	G 1"	24	83	115	56,7		
Kod. No	D	d	L	A	H																																			
102 122 131	G 1/4"	10	50	95	41,3																																			
102 122 132	G 3/8"	11	52	95	42,2																																			
102 122 133	1/2"	14,5	62	95	44,1																																			
102 122 134	3/4"	19	71	115	52,7																																			
102 122 135	G 1"	24	83	115	56,7																																			
	602 122 149	1/2" TERMOKUPL ÇIKIŞLI KÜRESEL VALF		56	24																																			
		<ul style="list-style-type: none"> Termokupl tipi hissedici kovani bulunur. Çalışma sıcaklık Aralığı: -30°C +80°C 																																						
	602 122 180	1 1/4" RAKORLU KÜRESEL VALF KIRMIZI KELEBEK VOLANLI		225	15																																			
	602 122 181	1 1/4" RAKORLU KÜRESEL VALF MAVİ KELEBEK VOLANLI		225	15																																			
		<ul style="list-style-type: none"> PN 16 Max. Çalışma Sıcaklığı: +80°C Max. Çalışma Basıncı: 10 bar <table border="1"> <thead> <tr> <th>Kod. No</th> <th>D</th> <th>d</th> <th>L</th> <th>A</th> <th>H</th> </tr> </thead> <tbody> <tr> <td>602 122 180/181</td> <td>G 1 1/4"</td> <td>Ø 32</td> <td>125</td> <td>82</td> <td>58,5</td> </tr> </tbody> </table>	Kod. No	D	d	L	A	H	602 122 180/181	G 1 1/4"	Ø 32	125	82	58,5																										
Kod. No	D	d	L	A	H																																			
602 122 180/181	G 1 1/4"	Ø 32	125	82	58,5																																			

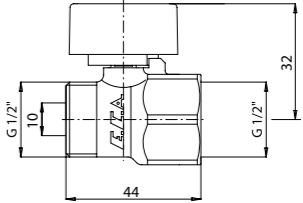
MİNİ KÜRESEL VALFLER (SU, YAĞ VE YANICI OLMAYAN GAZLAR İÇİN)

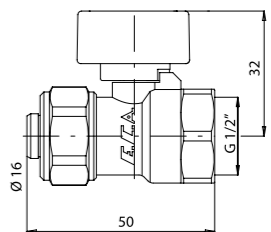



ÜRÜN	ÜRÜN KODU	ÜRÜN ADI	TEKNİK ÇİZİM	LİSTE FİYATI ₺	ÜRÜN KT. AD.																																							
	102 122 027	3/8" KÜRESEL VALF, KIRMIZI VOLAN İÇİDİŞ VIDA		32	30																																							
	102 122 028	1/2" KÜRESEL VALF, KIRMIZI VOLAN İÇİDİŞ VIDA		36	30																																							
	102 122 029	3/4" KÜRESEL VALF, KIRMIZI VOLAN İÇİDİŞ VIDA		49	15																																							
		<ul style="list-style-type: none"> TSEK PN10 Çalışma Sıcaklık Aralığı: -30C +80C Özel Plastik L volan <table border="1"> <thead> <tr> <th>Kod. No</th> <th>D₁</th> <th>D₂</th> <th>d(Ø)</th> <th>L</th> <th>H</th> <th>AA/SW</th> </tr> </thead> <tbody> <tr> <td>102 122 026</td> <td>G 1/4"</td> <td></td> <td>8</td> <td>40</td> <td>30</td> <td>21</td> </tr> <tr> <td>102 122 027</td> <td>G 3/8"</td> <td></td> <td>8</td> <td>40</td> <td>30</td> <td>22</td> </tr> <tr> <td>102 122 028</td> <td>1/2"</td> <td></td> <td>10</td> <td>44</td> <td>32</td> <td>25</td> </tr> <tr> <td>102 122 029</td> <td>3/4"</td> <td></td> <td>11</td> <td>50</td> <td>38</td> <td>31</td> </tr> <tr> <td>102 122 030</td> <td>G 1"</td> <td></td> <td>14,5</td> <td>57,5</td> <td>43</td> <td>38</td> </tr> </tbody> </table>		Kod. No	D ₁	D ₂	d(Ø)	L	H	AA/SW	102 122 026	G 1/4"		8	40	30	21	102 122 027	G 3/8"		8	40	30	22	102 122 028	1/2"		10	44	32	25	102 122 029	3/4"		11	50	38	31	102 122 030	G 1"		14,5	57,5	43
Kod. No	D ₁	D ₂	d(Ø)	L	H	AA/SW																																						
102 122 026	G 1/4"		8	40	30	21																																						
102 122 027	G 3/8"		8	40	30	22																																						
102 122 028	1/2"		10	44	32	25																																						
102 122 029	3/4"		11	50	38	31																																						
102 122 030	G 1"		14,5	57,5	43	38																																						
	602 122 003	1/2" MİNİ KÜRESEL VALF MAVİ VOLANLI İÇİDİŞ VIDA		36	30																																							
		<ul style="list-style-type: none"> TSEK PN10 Çalışma Sıcaklık Aralığı: -30C +80C Özel Plastik L volan 																																										
	kırmızı volanlı: 102 122 031 mavi volanlı: 102 122 348	1/2" RAKORLU MİNİ KÜRESEL VALF KENDİNDEN HORTUM UÇLU Ø 16X2 mm PEX		41	24																																							
		<ul style="list-style-type: none"> TSEK PN10 Çalışma Sıcaklık Aralığı: -30C +80C Özel Plastik T (kelebek) volan 																																										

* İlgili ürünler sipariş bazında özel üretilir.

• Fiyatlara KDV ayrıca dahil edilir. Tavsiye edilen bayi satış fiyatıdır.

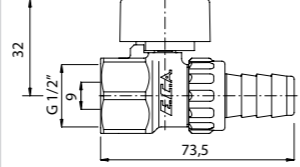
• Standart belgelerine ve belgelendirme kapsamındaki ürünlere www.eca.com.tr, www.valf.com.tr üzerinden ulaşılabilir. SİRKÜLER NO: S1920101

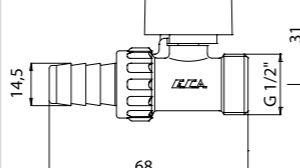
HORTUM UÇLU MİNİ KÜRESEL VALFLER (SU, YAĞ VE YANICI OLMAYAN GAZLAR İÇİN)

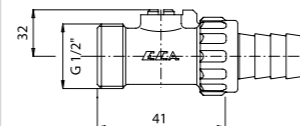
ÜRÜN	ÜRÜN KODU	ÜRÜN ADI	TEKNİK ÇİZİM	LİSTE FİYATI ₺	ÜRÜN KT. AD.
	kırmızı volanlı: 602 122 001* mavi volanlı: 602 122 009*	1/2" BOŞALTIMA MUSLUĞU • TSEK • PN10 • Çalışma Sıcaklık Aralığı: -30°C +80°C • Özel Plastik T(kelebek) volan		48	24
	kırmızı volanlı: 102 122 380 mavi volanlı: 102 122 379	1/2" BOŞALTIMA MUSLUĞU O - RİNGLİ • TSEK • PN10 • Çalışma Sıcaklık Aralığı: -30°C +80°C • Özel Plastik L volan • O-Ring sızdırmazlık halkalı		45	24
	602 122 004*	1/2" TORNAVİDA MİLLİ BOŞALTIMA MUSLUĞU • TSEK • PN10 • Çalışma Sıcaklık Aralığı: -30C +80C • O-Ring sızdırmazlık halkalı		43	24

* İlgili ürünler sipariş bazında özel üretilir.

• Standart belgelerine ve belgelendirme kapsamındaki ürünlere www.eca.com.tr, www.valf.com.tr üzerinden ulaşılabilir.
• Katalogda yer alan resimler bilgi içindir. Elmor Tesisat Malzemeleri Tic. A.Ş. mamul fiyat ve görünüş detaylarında değişiklik yapma hakkına sahiptir.

ŞİBER VALFLER

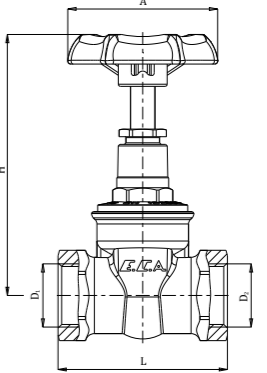
ÜRÜN	ÜRÜN KODU	ÜRÜN ADI	TEKNİK ÇİZİM	LİSTE FİYATI ₺	ÜRÜN KT. AD.																																	
	601 003 019	1/2" ŞİBER VALF		61	30																																	
	601 003 020	3/4" ŞİBER VALF		72	20																																	
	601 003 021	1" ŞİBER VALF		123	20																																	
	601 003 022	1 1/4" ŞİBER VALF		204	12																																	
	601 003 023	1 1/2" ŞİBER VALF		240	12																																	
	601 003 024	2" ŞİBER VALF		365	8																																	
		• TS EN 12288 • Özel plastik çevirme volanı • PN 25 • Max. çalışma sıcaklığı: 90°C																																				
		<table border="1"> <thead> <tr> <th>Kod. No</th> <th>D</th> <th>L</th> <th>H</th> <th>A</th> </tr> </thead> <tbody> <tr> <td>601 003 019</td> <td>1/2"</td> <td>55,5</td> <td>85</td> <td>49</td> </tr> <tr> <td>601 003 020</td> <td>3/4"</td> <td>58</td> <td>96</td> <td>59</td> </tr> <tr> <td>601 003 021</td> <td>G 1"</td> <td>68</td> <td>103</td> <td>59</td> </tr> <tr> <td>601 003 022</td> <td>G 1 1/4"</td> <td>78</td> <td>109</td> <td>68,5</td> </tr> <tr> <td>601 003 023</td> <td>G 1 1/2"</td> <td>80,5</td> <td>119</td> <td>68,5</td> </tr> <tr> <td>601 003 024</td> <td>G 2"</td> <td>93</td> <td>148</td> <td>83</td> </tr> </tbody> </table>	Kod. No	D	L	H	A	601 003 019	1/2"	55,5	85	49	601 003 020	3/4"	58	96	59	601 003 021	G 1"	68	103	59	601 003 022	G 1 1/4"	78	109	68,5	601 003 023	G 1 1/2"	80,5	119	68,5	601 003 024	G 2"	93	148	83	
Kod. No	D	L	H	A																																		
601 003 019	1/2"	55,5	85	49																																		
601 003 020	3/4"	58	96	59																																		
601 003 021	G 1"	68	103	59																																		
601 003 022	G 1 1/4"	78	109	68,5																																		
601 003 023	G 1 1/2"	80,5	119	68,5																																		
601 003 024	G 2"	93	148	83																																		

ŞİBER VALFLER, OPTİMİZE TİP

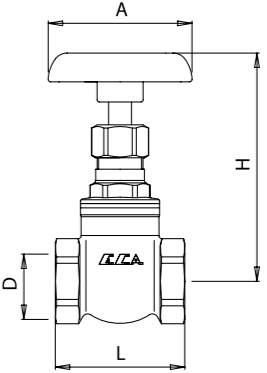
ÜRÜN	ÜRÜN KODU	ÜRÜN ADI	TEKNİK ÇİZİM	LİSTE FİYATI ₺	ÜRÜN KT. AD.																																																
	601 003 001	1/2" ŞİBER VALF		57	30																																																
	601 003 002	3/4" ŞİBER VALF		65	20																																																
	601 003 003	1" ŞİBER VALF		113	20																																																
	601 003 004	1 1/4" ŞİBER VALF		196	12																																																
	601 003 005	1 1/2" ŞİBER VALF		235	12																																																
	601 003 006	2" ŞİBER VALF		351	9																																																
	601 003 015	2 1/2" ŞİBER VALF		687	4																																																
	601 003 016	3" ŞİBER VALF		1.101	2																																																
	601 003 017	4" ŞİBER VALF		1.529	1																																																
		• Özel plastik çevirme volanı • PN 25 • Max. çalışma sıcaklığı: 90°C																																																			
		<table border="1"> <thead> <tr> <th>Kod. No</th> <th>D</th> <th>L</th> <th>H</th> <th>A</th> </tr> </thead> <tbody> <tr> <td>601 003 001</td> <td>1/2"</td> <td>40</td> <td>89</td> <td>50</td> </tr> <tr> <td>601 003 002</td> <td>3/4"</td> <td>49</td> <td>97</td> <td>60</td> </tr> <tr> <td>601 003 003</td> <td>G 1"</td> <td>50</td> <td>106,5</td> <td>60</td> </tr> <tr> <td>601 003 004</td> <td>G 1 1/4"</td> <td>58</td> <td>117</td> <td>70</td> </tr> <tr> <td>601 003 005</td> <td>G 1 1/2"</td> <td>62</td> <td>129</td> <td>70</td> </tr> <tr> <td>601 003 006</td> <td>G 2"</td> <td>68</td> <td>150</td> <td>80</td> </tr> <tr> <td>601 003 015</td> <td>G 2 1/2"</td> <td>78</td> <td>180,5</td> <td>110</td> </tr> <tr> <td>601 003 016</td> <td>G 3"</td> <td>90</td> <td>210</td> <td>110</td> </tr> <tr> <td>601 003 017</td> <td>G 4"</td> <td>102</td> <td>221</td> <td>130</td> </tr> </tbody> </table>	Kod. No	D	L	H	A	601 003 001	1/2"	40	89	50	601 003 002	3/4"	49	97	60	601 003 003	G 1"	50	106,5	60	601 003 004	G 1 1/4"	58	117	70	601 003 005	G 1 1/2"	62	129	70	601 003 006	G 2"	68	150	80	601 003 015	G 2 1/2"	78	180,5	110	601 003 016	G 3"	90	210	110	601 003 017	G 4"	102	221	130	
Kod. No	D	L	H	A																																																	
601 003 001	1/2"	40	89	50																																																	
601 003 002	3/4"	49	97	60																																																	
601 003 003	G 1"	50	106,5	60																																																	
601 003 004	G 1 1/4"	58	117	70																																																	
601 003 005	G 1 1/2"	62	129	70																																																	
601 003 006	G 2"	68	150	80																																																	
601 003 015	G 2 1/2"	78	180,5	110																																																	
601 003 016	G 3"	90	210	110																																																	
601 003 017	G 4"	102	221	130																																																	

• Fiyatlara KDV ayrıca dahil edilir. Tavsiye edilen bayi satış fiyatıdır.

• Standart belgelerine ve belgelendirme kapsamındaki ürünlere www.eca.com.tr, www.valf.com.tr üzerinden ulaşılabilir.
SİRKÜLER NO: S1920101

STOP VALFLER

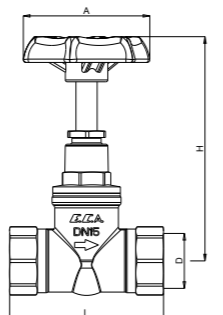
ÜRÜN	ÜRÜN KODU	ÜRÜN ADI	TEKNİK ÇİZİM	LİSTE FİYATI ₺	ÜRÜN KT. AD.																																		
	601 005 031	1/2" STOP VALF		60	60																																		
	601 005 032	3/4" STOP VALF		81	35																																		
	601 005 033	1" STOP VALF		133	20																																		
	601 005 034	1 1/4" STOP VALF		209	10																																		
	601 005 035	1 1/2" STOP VALF		288	8																																		
	601 005 036	2" STOP VALF		501	6																																		
				<ul style="list-style-type: none"> • TS 15 EN1213 • Özel plastik çevirme volanı • PN 10 • Max. çalışma sıcaklığı: 80°C 																																			
		<table border="1"> <thead> <tr> <th>Kod. No</th> <th>D</th> <th>L</th> <th>A</th> <th>H</th> </tr> </thead> <tbody> <tr> <td>601 005 031</td> <td>1/2"</td> <td>58</td> <td>49</td> <td>84</td> </tr> <tr> <td>601 005 032</td> <td>3/4"</td> <td>63</td> <td>58</td> <td>94</td> </tr> <tr> <td>601 005 033</td> <td>G 1"</td> <td>77</td> <td>58</td> <td>103</td> </tr> <tr> <td>601 005 034</td> <td>G1 1/4"</td> <td>94</td> <td>68.4</td> <td>125</td> </tr> <tr> <td>601 005 035</td> <td>G1 1/2"</td> <td>100</td> <td>82.7</td> <td>130.7</td> </tr> <tr> <td>601 005 036</td> <td>G 2"</td> <td>120</td> <td>82.7</td> <td>148.7</td> </tr> </tbody> </table>	Kod. No	D	L	A	H	601 005 031	1/2"	58	49	84	601 005 032	3/4"	63	58	94	601 005 033	G 1"	77	58	103	601 005 034	G1 1/4"	94	68.4	125	601 005 035	G1 1/2"	100	82.7	130.7	601 005 036	G 2"	120	82.7	148.7		
Kod. No	D	L	A	H																																			
601 005 031	1/2"	58	49	84																																			
601 005 032	3/4"	63	58	94																																			
601 005 033	G 1"	77	58	103																																			
601 005 034	G1 1/4"	94	68.4	125																																			
601 005 035	G1 1/2"	100	82.7	130.7																																			
601 005 036	G 2"	120	82.7	148.7																																			

FİLTRELER

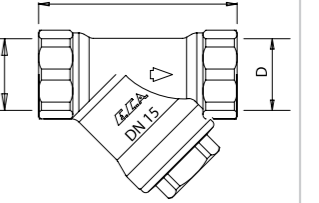
ÜRÜN	ÜRÜN KODU	ÜRÜN ADI	TEKNİK ÇİZİM	LİSTE FİYATI ₺	ÜRÜN KT. AD.																				
	601 010 001	1/2" FİLTRE		45	40																				
	601 010 002	3/4" FİLTRE		55	25																				
	601 010 003	1" FİLTRE		81	14																				
	601 010 004	1 1/4" FİLTRE		131	8																				
	601 010 005	1 1/2" FİLTRE		172	5																				
	601 010 006	2" FİLTRE		303	3																				
				<ul style="list-style-type: none"> • TSEK • Çalışma basıncı : 25 bar • Max. çalışma sıcaklığı : -30°C, +80°C • Özel paslanmaz çelik filtre (140 delik/cm2) 																					
		<table border="1"> <thead> <tr> <th>Kod. No</th> <th>D</th> <th>L</th> </tr> </thead> <tbody> <tr> <td>601 010 001</td> <td>1/2"</td> <td>57</td> </tr> <tr> <td>601 010 002</td> <td>3/4"</td> <td>69</td> </tr> <tr> <td>601 010 003</td> <td>G 1"</td> <td>86,7</td> </tr> <tr> <td>601 010 004</td> <td>G 1 1/4"</td> <td>92</td> </tr> <tr> <td>601 010 005</td> <td>G 1 1/2"</td> <td>102</td> </tr> <tr> <td>601 010 006</td> <td>G 2"</td> <td>122</td> </tr> </tbody> </table>	Kod. No	D	L	601 010 001	1/2"	57	601 010 002	3/4"	69	601 010 003	G 1"	86,7	601 010 004	G 1 1/4"	92	601 010 005	G 1 1/2"	102	601 010 006	G 2"	122		
Kod. No	D	L																							
601 010 001	1/2"	57																							
601 010 002	3/4"	69																							
601 010 003	G 1"	86,7																							
601 010 004	G 1 1/4"	92																							
601 010 005	G 1 1/2"	102																							
601 010 006	G 2"	122																							

KOSVA VALFLER

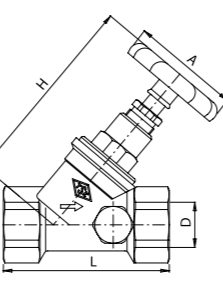
ÜRÜN	ÜRÜN KODU	ÜRÜN ADI	TEKNİK ÇİZİM	LİSTE FİYATI ₺	ÜRÜN KT. AD.																																		
	601 004 001	1/2" KOSVA VALF		88	40																																		
	601 004 002	3/4" KOSVA VALF		113	25																																		
	601 004 003	1" KOSVA VALF		165	15																																		
	601 004 004	1 1/4" KOSVA VALF		303	12																																		
	601 004 005	1 1/2" KOSVA VALF		355	8																																		
	601 004 006	2" KOSVA VALF		551	5																																		
				<ul style="list-style-type: none"> • Özel plastik çevirme volanı • Akış çıkış yönünde, sağ ve sol yana takılabilen özel plastik akuple boşaltma vanalı • PN 10 • Max. çalışma sıcaklığı: 80°C 																																			
		<table border="1"> <thead> <tr> <th>Kod. No</th> <th>D</th> <th>L</th> <th>H</th> <th>A</th> </tr> </thead> <tbody> <tr> <td>601 004 001</td> <td>1/2"</td> <td>57</td> <td>50</td> <td>84,5</td> </tr> <tr> <td>601 004 002</td> <td>3/4"</td> <td>67</td> <td>60</td> <td>100</td> </tr> <tr> <td>601 004 003</td> <td>G 1"</td> <td>78</td> <td>60</td> <td>118</td> </tr> <tr> <td>601 004 004</td> <td>G 1 1/4"</td> <td>92</td> <td>70</td> <td>137</td> </tr> <tr> <td>601 004 005</td> <td>G 1 1/2"</td> <td>102</td> <td>80</td> <td>152</td> </tr> <tr> <td>601 004 006</td> <td>G 2"</td> <td>122</td> <td>90</td> <td>177</td> </tr> </tbody> </table>	Kod. No	D	L	H	A	601 004 001	1/2"	57	50	84,5	601 004 002	3/4"	67	60	100	601 004 003	G 1"	78	60	118	601 004 004	G 1 1/4"	92	70	137	601 004 005	G 1 1/2"	102	80	152	601 004 006	G 2"	122	90	177		
Kod. No	D	L	H	A																																			
601 004 001	1/2"	57	50	84,5																																			
601 004 002	3/4"	67	60	100																																			
601 004 003	G 1"	78	60	118																																			
601 004 004	G 1 1/4"	92	70	137																																			
601 004 005	G 1 1/2"	102	80	152																																			
601 004 006	G 2"	122	90	177																																			

ÇALPARA ÇEKVALF

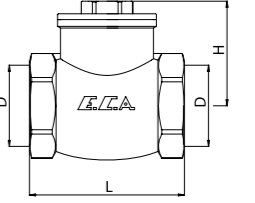
ÜRÜN	ÜRÜN KODU	ÜRÜN ADI	TEKNİK ÇİZİM	LİSTE FİYATI ₺	ÜRÜN KT. AD.															
	101 007 092	1/2" ÇALPARA ÇEKVALF		51	40															
	101 007 093	3/4" ÇALPARA ÇEKVALF		61	20															
	101 007 094	1" ÇALPARA ÇEKVALF		85	14															
				<ul style="list-style-type: none"> • TS EN 1074-3 • Özel askı tasarımı ile sarkaç tipi çalışan, kauçuk contalı klape grubu • Çalışma basıncı : 25 bar • Maksimum çalışma sıcaklığı : +80°C 																
		<table border="1"> <thead> <tr> <th>Kod. No</th> <th>D</th> <th>L</th> <th>H</th> </tr> </thead> <tbody> <tr> <td>101 007 092</td> <td>1/2"</td> <td>46,5</td> <td>31,5</td> </tr> <tr> <td>101 007 093</td> <td>3/4"</td> <td>56,5</td> <td>34,5</td> </tr> <tr> <td>101 007 094</td> <td>G 1"</td> <td>63</td> <td>39</td> </tr> </tbody> </table>	Kod. No	D	L	H	101 007 092	1/2"	46,5	31,5	101 007 093	3/4"	56,5	34,5	101 007 094	G 1"	63	39		
Kod. No	D	L	H																	
101 007 092	1/2"	46,5	31,5																	
101 007 093	3/4"	56,5	34,5																	
101 007 094	G 1"	63	39																	

• Fiyatlara KDV ayrıca dahil edilir. Tavsiye edilen bayi satış fiyatıdır.

• Standart belgelerine ve belgelendirme kapsamındaki ürünlere www.eca.com.tr, www.valf.com.tr üzerinden ulaşılabilir. SİRKÜLER NO: S1920101

YATAY ÇEKVALF

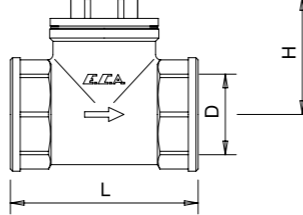
ÜRÜN	ÜRÜN KODU	ÜRÜN ADI	TEKNİK ÇİZİM	LİSTE FİYATI ₺	ÜRÜN KT. AD.																											
	601 007 022	1/2" ÇEKVALF		69	35																											
	601 007 023	3/4" ÇEKVALF		95	14																											
	601 007 024	1" ÇEKVALF		140	14																											
	601 007 025	1 1/4" ÇEKVALF		253	6																											
	601 007 026	1 1/2" ÇEKVALF		337	10																											
	601 007 027	2" ÇEKVALF		501	5																											
		<ul style="list-style-type: none"> • TS EN 1074-3 • Klape tasarımından dolayı yatay monte edilmelidir. • Çalışma basıncı : 25 bar • Maksimum çalışma sıcaklığı : +80°C <table border="1"> <thead> <tr> <th>Kod. No</th> <th>D</th> <th>L</th> <th>H</th> </tr> </thead> <tbody> <tr> <td>601 007 022</td> <td>1/2"</td> <td>55</td> <td>32</td> </tr> <tr> <td>601 007 023</td> <td>3/4"</td> <td>65</td> <td>36,5</td> </tr> <tr> <td>601 007 024</td> <td>G 1"</td> <td>75</td> <td>39,3</td> </tr> <tr> <td>601 007 025</td> <td>G 1 1/4"</td> <td>88</td> <td>49,8</td> </tr> <tr> <td>601 007 026</td> <td>G 1 1/2"</td> <td>98</td> <td>56,3</td> </tr> <tr> <td>601 007 027</td> <td>G 2"</td> <td>116</td> <td>66</td> </tr> </tbody> </table>		Kod. No	D	L	H	601 007 022	1/2"	55	32	601 007 023	3/4"	65	36,5	601 007 024	G 1"	75	39,3	601 007 025	G 1 1/4"	88	49,8	601 007 026	G 1 1/2"	98	56,3	601 007 027	G 2"	116	66	
Kod. No	D	L	H																													
601 007 022	1/2"	55	32																													
601 007 023	3/4"	65	36,5																													
601 007 024	G 1"	75	39,3																													
601 007 025	G 1 1/4"	88	49,8																													
601 007 026	G 1 1/2"	98	56,3																													
601 007 027	G 2"	116	66																													

KUYU ÇEKVALF

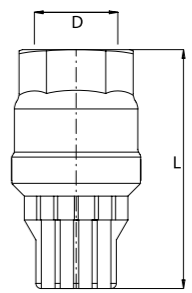
ÜRÜN	ÜRÜN KODU	ÜRÜN ADI	TEKNİK ÇİZİM	LİSTE FİYATI ₺	ÜRÜN KT. AD.																		
	601 007 017	3/4" KUYU ÇEKVALF		52	20																		
	601 007 018	1" KUYU ÇEKVALF		61	15																		
	601 007 019	1 1/4" KUYU ÇEKVALF		97	15																		
	601 007 020	1 1/2" KUYU ÇEKVALF		136	8																		
	601 007 021	2" KUYU ÇEKVALF		212	6																		
		<ul style="list-style-type: none"> • TS EN 1074-3 • Özel tasarımı, yay mekanizmalı klape grubu • Giriş tarafı plastik süzgeçli • Çalışma basıncı : 25 bar • Maksimum çalışma sıcaklığı : +80°C <table border="1"> <thead> <tr> <th>Kod. No</th> <th>D</th> <th>L</th> </tr> </thead> <tbody> <tr> <td>601 007 017</td> <td>3/4"</td> <td>80</td> </tr> <tr> <td>601 007 018</td> <td>G 1"</td> <td>93</td> </tr> <tr> <td>601 007 019</td> <td>G 1 1/4"</td> <td>100</td> </tr> <tr> <td>601 007 020</td> <td>G 1 1/2"</td> <td>110</td> </tr> <tr> <td>601 007 021</td> <td>G 2"</td> <td>120</td> </tr> </tbody> </table>		Kod. No	D	L	601 007 017	3/4"	80	601 007 018	G 1"	93	601 007 019	G 1 1/4"	100	601 007 020	G 1 1/2"	110	601 007 021	G 2"	120		
Kod. No	D	L																					
601 007 017	3/4"	80																					
601 007 018	G 1"	93																					
601 007 019	G 1 1/4"	100																					
601 007 020	G 1 1/2"	110																					
601 007 021	G 2"	120																					

YAYLI ÇEKVALF

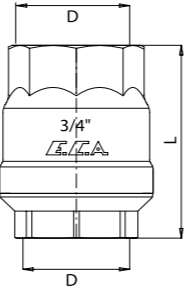
ÜRÜN	ÜRÜN KODU	ÜRÜN ADI	TEKNİK ÇİZİM	LİSTE FİYATI ₺	ÜRÜN KT. AD.																				
	601 007 007	1/2" YAYLI ÇEKVALF		37	20																				
	601 007 008	3/4" YAYLI ÇEKVALF		43	15																				
	601 007 009	1" YAYLI ÇEKVALF		61	10																				
	601 007 010	1 1/4" YAYLI ÇEKVALF		88	6																				
	601 007 011	1 1/2" YAYLI ÇEKVALF		160	4																				
	601 007 012	2" YAYLI ÇEKVALF		231	3																				
		<ul style="list-style-type: none"> • TS EN 1074-3 • Özel tasarımı, yay mekanizmalı klape grubu • Çalışma basıncı: 25 bar • Maksimum çalışma sıcaklığı : +80°C <table border="1"> <thead> <tr> <th>Kod. No</th> <th>D</th> <th>L</th> </tr> </thead> <tbody> <tr> <td>601 007 007</td> <td>1/2"</td> <td>40</td> </tr> <tr> <td>601 007 008</td> <td>3/4"</td> <td>50</td> </tr> <tr> <td>601 007 009</td> <td>G 1"</td> <td>62,5</td> </tr> <tr> <td>601 007 010</td> <td>G 1 1/4"</td> <td>67</td> </tr> <tr> <td>601 007 011</td> <td>G 1 1/2"</td> <td>77</td> </tr> <tr> <td>601 007 012</td> <td>G 2"</td> <td>85</td> </tr> </tbody> </table>		Kod. No	D	L	601 007 007	1/2"	40	601 007 008	3/4"	50	601 007 009	G 1"	62,5	601 007 010	G 1 1/4"	67	601 007 011	G 1 1/2"	77	601 007 012	G 2"	85	
Kod. No	D	L																							
601 007 007	1/2"	40																							
601 007 008	3/4"	50																							
601 007 009	G 1"	62,5																							
601 007 010	G 1 1/4"	67																							
601 007 011	G 1 1/2"	77																							
601 007 012	G 2"	85																							



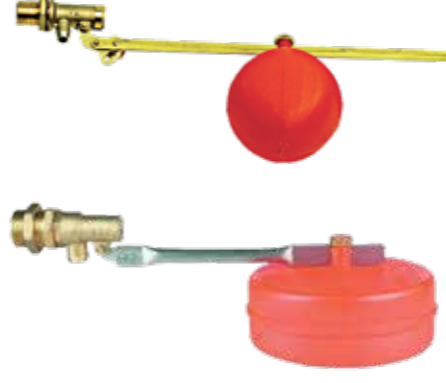







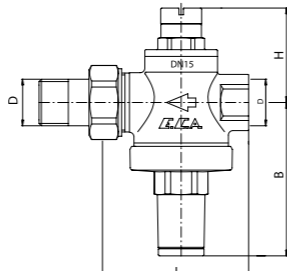

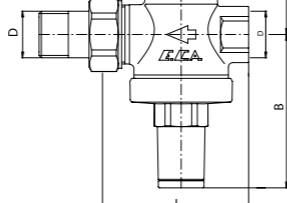

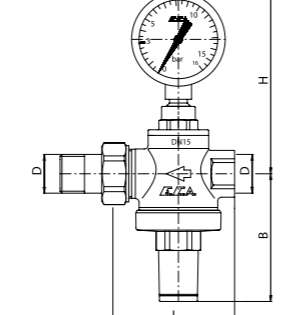

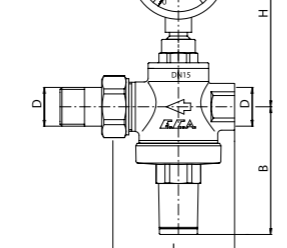

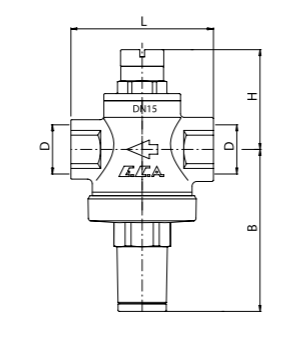

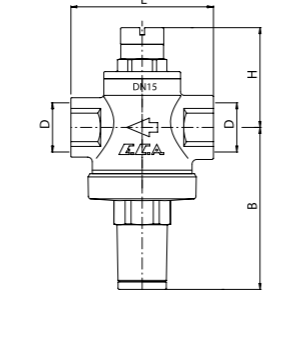

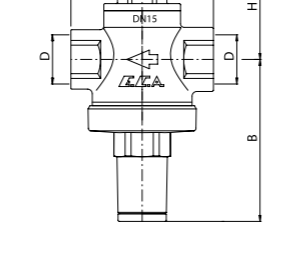
FLATÖRLER

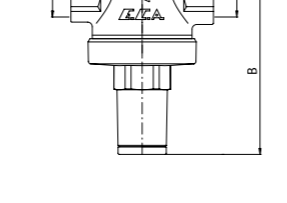
ÜRÜN	ÜRÜN KODU	ÜRÜN ADI	LİSTE FİYATI ₺	ÜRÜN KT. AD.																																
	101 009 001	3/8" FLATÖR	97	20																																
	101 009 002	1/2" FLATÖR	101	20																																
	101 009 003	3/4" FLATÖR	128	10																																
	101 009 004	1" FLATÖR	147	10																																
	101 009 005	1 1/4" FLATÖR	316	4																																
	101 009 006	1 1/2" FLATÖR	340	4																																
	101 009 007	2" FLATÖR	415	4																																
		<ul style="list-style-type: none"> • TSEK • Çalışma basıncı : 6 bar • Maksimum çalışma sıcaklığı : +80°C • Çalışma basıncının üzerinden kullanımlarda mutlaka basınç düşürücü kullanınız. <table border="1"> <thead> <tr> <th>Kod. No</th> <th>D</th> <th>L</th> <th>H</th> </tr> </thead> <tbody> <tr> <td>101 009 001</td> <td>G 3/8"</td> <td>348</td> <td>95</td> </tr> <tr> <td>101 009 002</td> <td>1/2"</td> <td>335</td> <td>95</td> </tr> <tr> <td>101 009 003</td> <td>3/4"</td> <td>375</td> <td>107,3</td> </tr> <tr> <td>101 009 004</td> <td>G 1"</td> <td>375</td> <td>107,3</td> </tr> <tr> <td>101 009 005</td> <td>G 1 1/4"</td> <td>415</td> <td>96,2</td> </tr> <tr> <td>101 009 006</td> <td>G 1 1/2"</td> <td>415</td> <td>96,2</td> </tr> <tr> <td>101 009 007</td> <td>G 2"</td> <td>415</td> <td>96,2</td> </tr> </tbody> </table>	Kod. No	D	L	H	101 009 001	G 3/8"	348	95	101 009 002	1/2"	335	95	101 009 003	3/4"	375	107,3	101 009 004	G 1"	375	107,3	101 009 005	G 1 1/4"	415	96,2	101 009 006	G 1 1/2"	415	96,2	101 009 007	G 2"	415	96,2		
Kod. No	D	L	H																																	
101 009 001	G 3/8"	348	95																																	
101 009 002	1/2"	335	95																																	
101 009 003	3/4"	375	107,3																																	
101 009 004	G 1"	375	107,3																																	
101 009 005	G 1 1/4"	415	96,2																																	
101 009 006	G 1 1/2"	415	96,2																																	
101 009 007	G 2"	415	96,2																																	

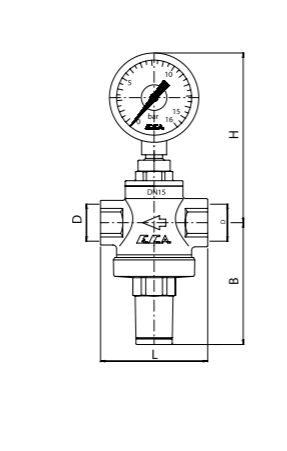

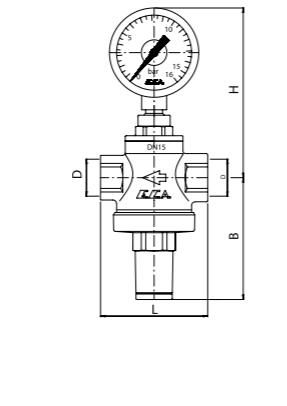
• Fiyatlara KDV ayrıca dahil edilir. Tavsiye edilen bayi satış fiyatıdır.

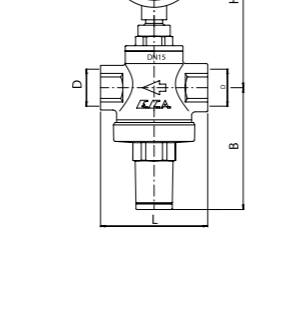
• Standart belgelerine ve belgelendirme kapsamındaki ürünlere www.eca.com.tr, www.valf.com.tr üzerinden ulaşılabilir. SİRKÜLER NO: S1920101

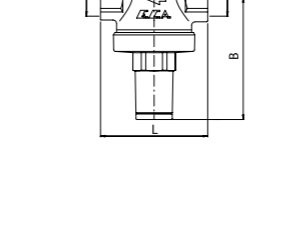
SU BASINÇ DÜŞÜRÜCÜ VALFLER

ÜRÜN	ÜRÜN KODU	ÜRÜN ADI	TEKNİK ÇİZİM	LİSTE FİYATI ₺	ÜRÜN KT. AD.																								
	602 111 007	1/2" BASINÇ DÜŞÜRÜCÜ VALF PİSTONLU, İÇ VIDA X RAKORLU		188	10																								
	102 199 160	3/4" BASINÇ DÜŞÜRÜCÜ VALF PİSTONLU, İÇ VIDA X RAKORLU		208	10																								
		<table border="1"> <thead> <tr> <th>Kod. No</th> <th>D</th> <th>L</th> <th>H</th> <th>A</th> </tr> </thead> <tbody> <tr> <td>602 111 007</td> <td>1/2"</td> <td>60</td> <td>68</td> <td>42</td> </tr> <tr> <td>602 199 160</td> <td>3/4"</td> <td>60</td> <td>68</td> <td>42</td> </tr> </tbody> </table>	Kod. No	D	L	H	A	602 111 007	1/2"	60	68	42	602 199 160	3/4"	60	68	42												
Kod. No	D	L	H	A																									
602 111 007	1/2"	60	68	42																									
602 199 160	3/4"	60	68	42																									
	602 111 006	1/2" MANOMETRELİ BASINÇ DÜŞÜRÜCÜ VALF PİSTONLU, İÇ VIDA X RAKORLU		257	6																								
	602 111 008	3/4" MANOMETRELİ BASINÇ DÜŞÜRÜCÜ VALF PİSTONLU, İÇ VIDA X RAKORLU		277	6																								
		<table border="1"> <thead> <tr> <th>Kod. No</th> <th>D</th> <th>L</th> <th>H</th> <th>A</th> </tr> </thead> <tbody> <tr> <td>602 111 006</td> <td>1/2"</td> <td>65</td> <td>68</td> <td>95</td> </tr> <tr> <td>602 111 008</td> <td>3/4"</td> <td>65,8</td> <td>68</td> <td>95</td> </tr> </tbody> </table>	Kod. No	D	L	H	A	602 111 006	1/2"	65	68	95	602 111 008	3/4"	65,8	68	95												
Kod. No	D	L	H	A																									
602 111 006	1/2"	65	68	95																									
602 111 008	3/4"	65,8	68	95																									
	602 111 004	1/2" BASINÇ DÜŞÜRÜCÜ VALF PİSTONLU, İÇ VIDA X İÇ VIDA		172	10																								
	602 111 009	3/4" BASINÇ DÜŞÜRÜCÜ VALF PİSTONLU, İÇ VIDA X İÇ VIDA		192	10																								
	602 111 038	1" BASINÇ DÜŞÜRÜCÜ VALF PİSTONLU, İÇ VIDA X İÇ VIDA		325	8																								
	602 111 037	1 1/4" BASINÇ DÜŞÜRÜCÜ VALF PİSTONLU, İÇ VIDA X İÇ VIDA		345	4																								
		<table border="1"> <thead> <tr> <th>Kod. No</th> <th>D</th> <th>L</th> <th>B</th> <th>H</th> </tr> </thead> <tbody> <tr> <td>602 111 004</td> <td>1/2"</td> <td>60</td> <td>68</td> <td>48</td> </tr> <tr> <td>602 111 009</td> <td>3/4"</td> <td>60</td> <td>68</td> <td>48</td> </tr> <tr> <td>602 111 038</td> <td>G 1"</td> <td>81</td> <td>97,7</td> <td>59</td> </tr> <tr> <td>602 111 037</td> <td>G 1 1/4"</td> <td>88</td> <td>97,7</td> <td>59</td> </tr> </tbody> </table>	Kod. No	D	L	B	H	602 111 004	1/2"	60	68	48	602 111 009	3/4"	60	68	48	602 111 038	G 1"	81	97,7	59	602 111 037	G 1 1/4"	88	97,7	59		
Kod. No	D	L	B	H																									
602 111 004	1/2"	60	68	48																									
602 111 009	3/4"	60	68	48																									
602 111 038	G 1"	81	97,7	59																									
602 111 037	G 1 1/4"	88	97,7	59																									
	602 111 005	1/2" MANOMETRELİ BASINÇ DÜŞÜRÜCÜ VALF PİSTONLU, İÇ VIDA X İÇ VIDA		241	6																								
	602 111 010	3/4" MANOMETRELİ BASINÇ DÜŞÜRÜCÜ VALF PİSTONLU, İÇ VIDA X İÇ VIDA		261	6																								
	602 111 042	1" MANOMETRELİ BASINÇ DÜŞÜRÜCÜ VALF PİSTONLU, İÇ VIDA X İÇ VIDA		383	8																								
	602 111 041	1 1/4" MANOMETRELİ BASINÇ DÜŞÜRÜCÜ VALF PİSTONLU, İÇ VIDA X İÇ VIDA		403	4																								
		<table border="1"> <thead> <tr> <th>Kod. No</th> <th>D</th> <th>L</th> <th>B</th> <th>H</th> </tr> </thead> <tbody> <tr> <td>602 111 005</td> <td>1/2"</td> <td>60</td> <td>68</td> <td>95</td> </tr> <tr> <td>602 111 010</td> <td>3/4"</td> <td>60</td> <td>68</td> <td>95</td> </tr> <tr> <td>602 111 042</td> <td>G 1"</td> <td>81</td> <td>97,7</td> <td>110,7</td> </tr> <tr> <td>602 111 041</td> <td>G 1 1/4"</td> <td>88</td> <td>97,7</td> <td>110,7</td> </tr> </tbody> </table>	Kod. No	D	L	B	H	602 111 005	1/2"	60	68	95	602 111 010	3/4"	60	68	95	602 111 042	G 1"	81	97,7	110,7	602 111 041	G 1 1/4"	88	97,7	110,7		
Kod. No	D	L	B	H																									
602 111 005	1/2"	60	68	95																									
602 111 010	3/4"	60	68	95																									
602 111 042	G 1"	81	97,7	110,7																									
602 111 041	G 1 1/4"	88	97,7	110,7																									

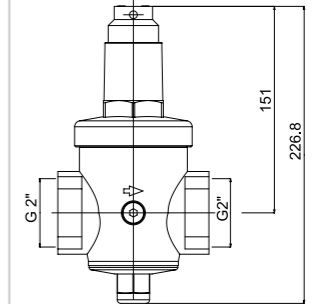
SU BASINÇ DÜŞÜRÜCÜ VALFLER

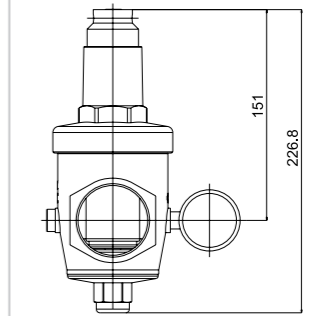
ÜRÜN	ÜRÜN KODU	ÜRÜN ADI	TEKNİK ÇİZİM	LİSTE FİYATI ₺	ÜRÜN KT. AD.
	602 111 018	2" BASINÇ DÜŞÜRÜCÜ VALF PİSTONLU, İÇ VIDA X RAKORLU		1.180	1
	602 111 019	2" MANOMETRELİ BASINÇ DÜŞÜRÜCÜ VALF PİSTONLU, İÇ VIDA X RAKORLU		1.237	1

Teknik Özellikler:



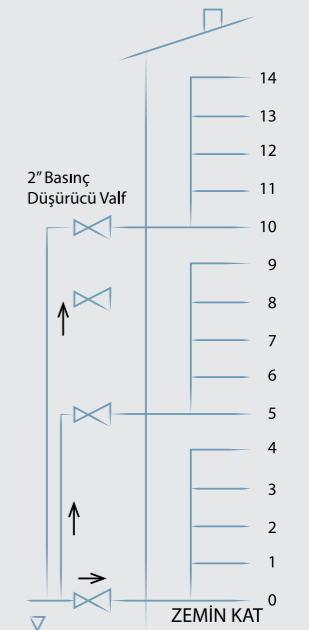
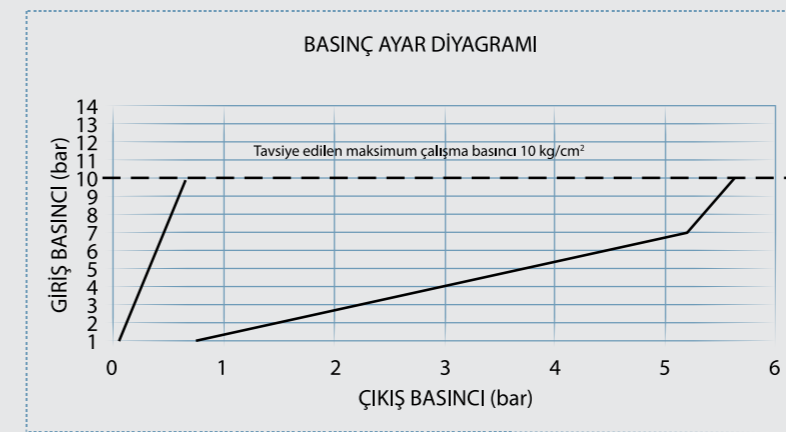

- TS EN 1567
- Paslanmaz çelik Piston klape
- Çalışma basıncı: 16 bar
- Çıkış Ayar basıncı: 1~5 bar
- Fabrika ayarı: 8 bar giriş - 3bar çıkış
- Çıkış basıncında giriş basıncına yada ihtiyaca göre Allen yardımı ile farklı ayar imkanı.
- Maksimum çalışma sıcaklığı : +80°C





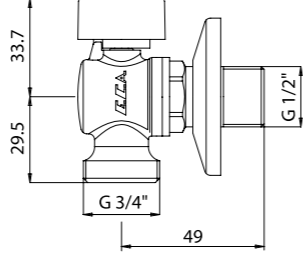

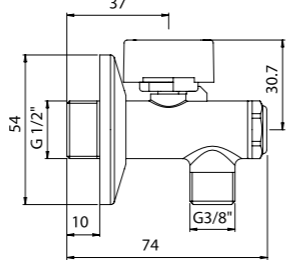
• Fiyatlara KDV ayrıca dahil edilir. Tavsiye edilen bayi satış fiyatıdır.

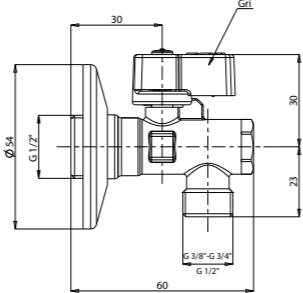
• Standart belgelerine ve belgelendirme kapsamındaki ürünlere www.eca.com.tr, www.valf.com.tr üzerinden ulaşılabilir. SİRKÜLER NO: S1920101

KÜRESEL TİP MUSLUKLAR

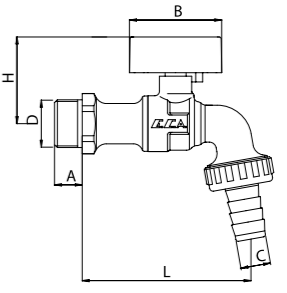
ÜRÜN	ÜRÜN KODU	ÜRÜN ADI	TEKNİK ÇİZİM	LİSTE FİYATI ₺	ÜRÜN KT. AD.
	102 122 041	1/2" ÇAMAŞIR - BULAŞIK MAKİNASI MUSLUĞU, ROZET DAHİL • TSEK • Polisajlı krom kaplama • Çalışma basıncı : 10 bar • Maksimum çalışma sıcaklığı : +80°C • Çıkış ucu 3/4"		117	25
	102 111 018	1/2" FİLTRELİ ARA MUSLUK, UZUN TİP (ROZET DAHİL) • TSEK • Polisajlı krom kaplama • Çalışma basıncı : 10 bar • Maksimum çalışma sıcaklığı : +80°C • Çıkış ucu 3/8"		72	30
	602 111 043	1/2" FİLTRELİ ARA MUSLUK, KISA TİP 3/8" ÇIKIŞ AĞIZLI (ROZET DAHİL)		39	30
	602 111 052	1/2" FİLTRELİ ARA MUSLUK, KISA TİP 1/2" ÇIKIŞ AĞIZLI (ROZET DAHİL)		39	30
	602 111 059	1/2" FİLTRELİ ARA MUSLUK, KISA TİP 3/4" ÇIKIŞ AĞIZLI (ROZET DAHİL)		43	30
	602 111 048	1/2" FİLTRELİ ARA MUSLUK, KISA TİP 3/8" ÇIKIŞ AĞIZLI KROM VOLAN - (ROZET DAHİL) • TSEK • Nikel kaplama • Özel plastik L volan • Çalışma basıncı : 10 bar • Maksimum çalışma sıcaklığı : +80°C • Çıkış ucu 3/8", 3/4", 1/2"		40	30

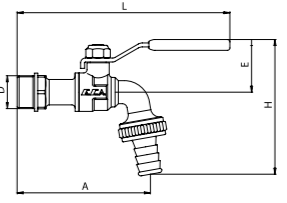
KÜRESEL TİP MUSLUKLAR

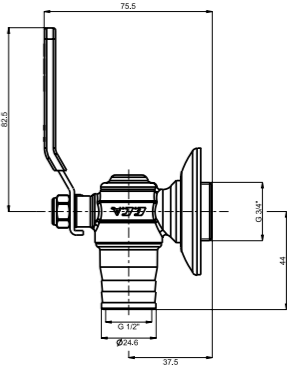
ÜRÜN	ÜRÜN KODU	ÜRÜN ADI	TEKNİK ÇİZİM	LİSTE FİYATI ₺	ÜRÜN KT. AD.
	102 109 045	1/2" KÜRESEL BOŞALTMA MUSLUĞU		111	24
	102 109 046	3/4" KÜRESEL BOŞALTMA MUSLUĞU • TSEK • Nikel kaplama • Özel plastik T(kelebek) volan • Rakorlu hortum ucu • Çalışma basıncı : 10 bar • Maksimum çalışma sıcaklığı : +80°C		136	15
	602 109 004	1/2" KÜRESEL BOŞALTMA MUSLUĞU		99	30
	602 109 005	3/4" KÜRESEL BOŞALTMA MUSLUĞU • TSEK • Nikel kaplama • 90° çevirme kolu • Rakorlu hortum ucu • Çalışma basıncı : 10 bar • Maksimum çalışma sıcaklığı : +80°C		119	30
	102 109 120	3/4" KÜRESEL BAS, SABİT HORTUM UÇLU (MUSLUK ROZETİ DAHİL) • TSEK • Nikel kaplama • 90° çevirme kolu • Sabit hortum ucu • Çalışma basıncı : 10 bar • Maksimum çalışma sıcaklığı : +80°C		111	40

• Fiyatlara KDV ayrıca dahil edilir. Tavsiye edilen bayi satış fiyatıdır.

• Standart belgelerine ve belgelendirme kapsamındaki ürünlere www.eca.com.tr, www.valf.com.tr üzerinden ulaşılabilir. SİRKÜLER NO: S1920101

YERDEN ISITMA SİSTEMLERİ

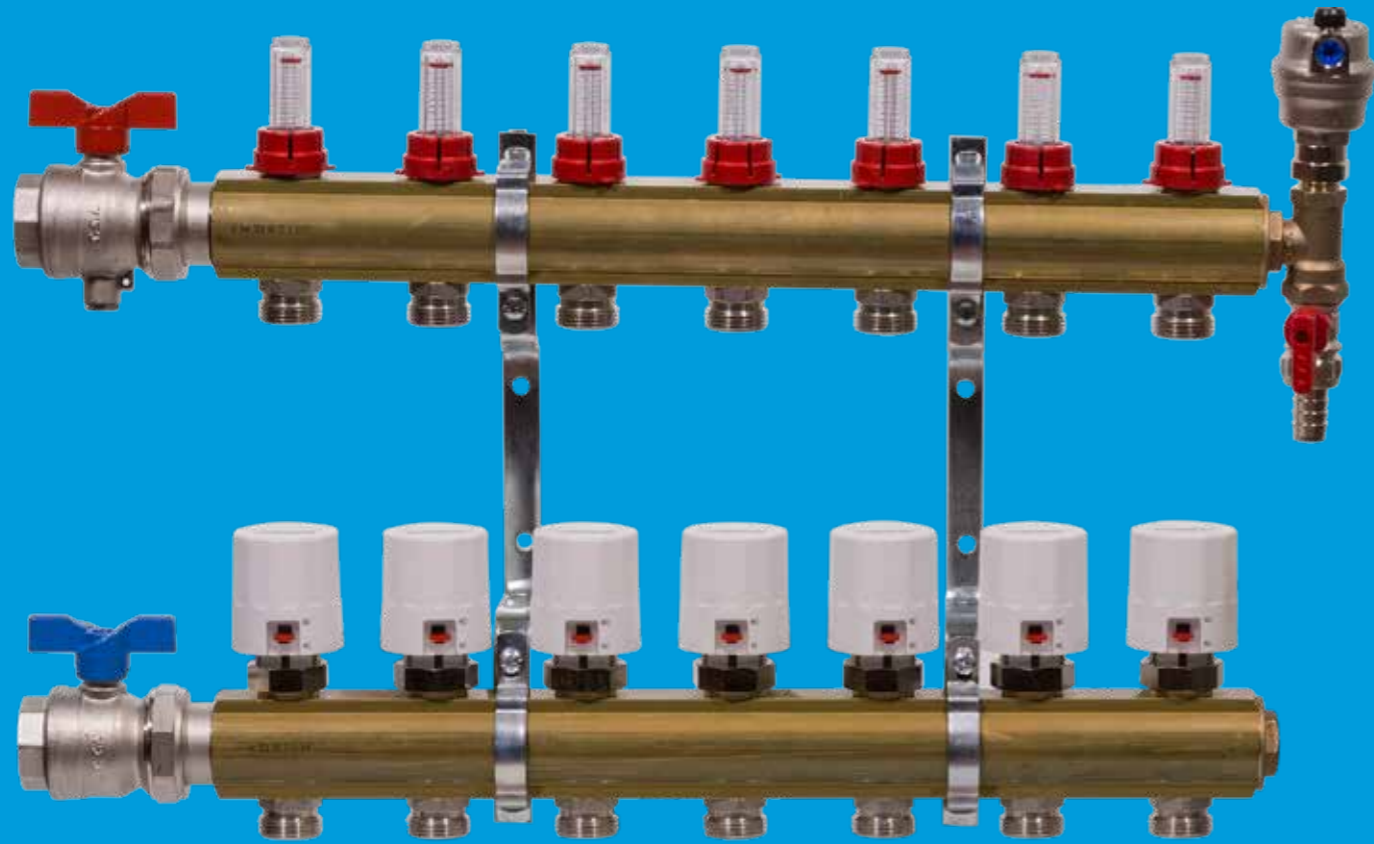



YERDEN ISITMA DEBİMETRELİ KOLLEKTÖR SETİ

ÜRÜN	ÜRÜN KODU	ÜRÜN ADI	LİSTE FİYATI ₺	ÜRÜN KT. AD.
	601 026 097	DEBİMETRELİ KOLLEKTÖR SET, 2'Lİ	426	12
	601 026 098	DEBİMETRELİ KOLLEKTÖR SET, 3'LÜ	611	9
	601 026 099	DEBİMETRELİ KOLLEKTÖR SET, 4'LÜ	795	6
	601 026 100	DEBİMETRELİ KOLLEKTÖR SET, 5'Lİ	961	4
	601 026 101	DEBİMETRELİ KOLLEKTÖR SET, 6'Lİ	1.146	4
	601 026 102	DEBİMETRELİ KOLLEKTÖR SET, 7'Lİ	1.330	4
	601 026 103	DEBİMETRELİ KOLLEKTÖR SET, 8'Lİ	1.497	3
	601 026 104	DEBİMETRELİ KOLLEKTÖR SET, 9'LU	1.682	3
	601 026 105	DEBİMETRELİ KOLLEKTÖR SET, 10'LU	1.849	3
	601 026 106	DEBİMETRELİ KOLLEKTÖR SET, 11'Lİ	2.033	2
	601 026 107	DEBİMETRELİ KOLLEKTÖR SET, 12'Lİ	2.218	2
	601 026 108	DEBİMETRELİ KOLLEKTÖR SET, 13'LÜ	2.384	2

Kod No.	Çıkış Sayısı	D	d	L
601 026 097	2	G1"	3/4"	128,5
601 026 098	3			188,5
601 026 099	4			248,5
601 026 100	5			308,5
601 026 101	6			368,5
601 026 102	7			428,5
601 026 103	8			488,5
601 026 104	9			548,5
601 026 105	10			608,5
601 026 106	11			668,5
601 026 107	12			728,5
601 026 108	13			788,5

- Çalışma basıncı 6 bar
- Test basıncı 10 bar (20°C)
- Kullanma sıcaklığı -10°C - 70°C
- Gidiş kolektörü debi ayar klapeli ve debi göstergelidir.
- Dönüş kolektörü aktuatör montajına uygun hat ayar vanalıdır.
- Kollektör tapaları dahildir.

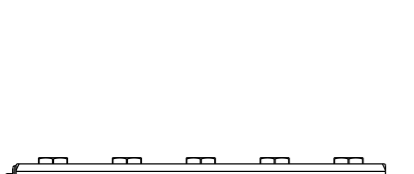
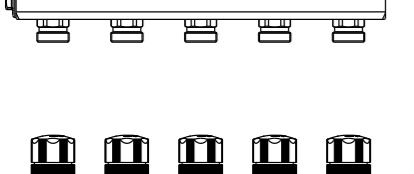
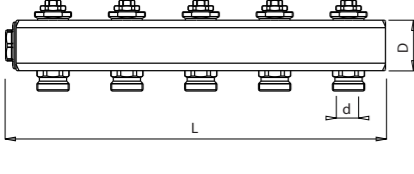
YERDEN ISITMA DEBİMETRESİZ KOLLEKTÖR SETİ

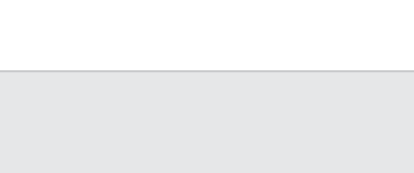
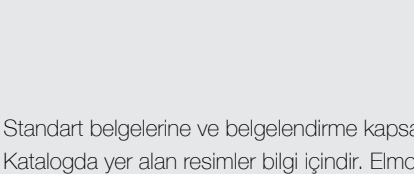
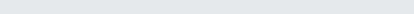
ÜRÜN	ÜRÜN KODU	ÜRÜN ADI	LİSTE FİYATI ₺	ÜRÜN KT. AD.
	601 026 109	DEBİMETRESİZ KOLLEKTÖR SET, 2'Lİ	351	12
	601 026 110	DEBİMETRESİZ KOLLEKTÖR SET, 3'LÜ	500	9
	601 026 111	DEBİMETRESİZ KOLLEKTÖR SET, 4'LÜ	629	6
	601 026 112	DEBİMETRESİZ KOLLEKTÖR SET, 5'Lİ	777	4
	601 026 113	DEBİMETRESİZ KOLLEKTÖR SET, 6'Lİ	924	4
	601 026 114	DEBİMETRESİZ KOLLEKTÖR SET, 7'Lİ	1.054	4
	601 026 115	DEBİMETRESİZ KOLLEKTÖR SET, 8'Lİ	1.201	3
	601 026 116	DEBİMETRESİZ KOLLEKTÖR SET, 9'LU	1.330	3
	601 026 117	DEBİMETRESİZ KOLLEKTÖR SET, 10'LU	1.479	3
	601 026 118	DEBİMETRESİZ KOLLEKTÖR SET, 11'Lİ	1.608	2
	601 026 119	DEBİMETRESİZ KOLLEKTÖR SET, 12'Lİ	1.756	2
	601 026 120	DEBİMETRESİZ KOLLEKTÖR SET, 13'LÜ	1.904	2

• Çalışma Basıncı: 6 bar
• Test Basıncı: 10 bar (20°C)
• Kullanma sıcaklığı: -10°C , +70°C
• Gidiş kollektöründe debi ayar klape grupları yoktur.
• Dönüş kollektörü aktuatör montajına uygun hat ayar vanalıdır.
• Kollektör tapaları dahildir.

Kod No.	Çıkış Sayısı	D	d	L
601 026 109	2	G1"	3/4"	128,5
601 026 110	3			188,5
601 026 111	4			248,5
601 026 112	5			308,5
601 026 113	6			368,5
601 026 114	7			428,5
601 026 115	8			488,5
601 026 116	9			548,5
601 026 117	10			608,5
601 026 118	11			668,5
601 026 119	12			728,5
601 026 120	13			788,5

TERMAL KONTROL VANA MOTORU (AKTÜATÖR)

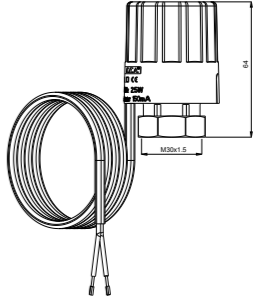
ÜRÜN	ÜRÜN KODU	ÜRÜN ADI	TEKNİK ÇİZİM	LİSTE FİYATI ₺	ÜRÜN KT. AD.
	602 120 742	M30X1.5 AKTÜATÖR TERMAL KONTROL VANA MOTORU 230V • CE • Normalde Kapalı(NC). İstenildiğinde Normalde Açık(NO) değişimi yapılabilir. • Açık ve Kapalı Konum göstergeli. • Gerilim 230V • Çevrim süresi:4.5 dakika • Hareket Mesafesi 3 mm • İtme kuvveti 90-125N • Güç 2.5W • Akım 150mA		140	10

2-YOLLU TERMAL KONTROL MOTORLU (AKTÜATÖRLÜ) VANA

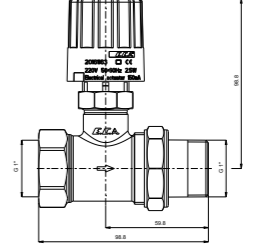
ÜRÜN	ÜRÜN KODU	ÜRÜN ADI	TEKNİK ÇİZİM	LİSTE FİYATI ₺	ÜRÜN KT. AD.
	602 120 747	2-YOLLU 1" AKTÜATÖRLÜ VANA - ÇIKIŞ RAKORLU		287	2
	602 120 804	2-YOLLU 1" AKTÜATÖRLÜ VANA DIŞ VİDA x RAKOR BAĞLANTILI		287	2
	602 120 863	2-YOLLU 1" AKTÜATÖRLÜ VANA-GİRİŞ RAKORLU • E.C.A. Aktuatör ve E.C.A. Oda Termostatı ile uyumlu çalışır. • Vana PN16		287	2

ANA KONTROL ÜNİTESİ

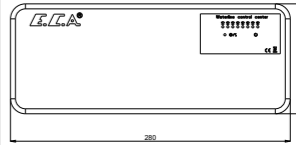
ÜRÜN	ÜRÜN KODU	ÜRÜN ADI	TEKNİK ÇİZİM	LİSTE FİYATI ₺	ÜRÜN KT. AD.
	601 021 010	ANA KONTROL ÜNİTESİ ELEKTRİK SİNYAL DAĞITICI (8 ÇIKIŞLI) • CE • Oda Termostatları, aktuatör, pompa ve karışım valflerinin entegrasyonu/kontrolü. • Çalışma konum gösterge lambaları • Elektrik ve Termal emniyeti • Güç kaynağı: 100-240 VAC 50/60 Hz • Max. Toplam Akım: 10 A • Çalışma Sıcaklığı: -20 °C -60°C • Depolama Sıcaklığı: -20 °C -70 °C		453	3

• Fiyatlara KDV ayrıca dahil edilir. Tavsiye edilen bayi satış fiyatıdır.

• Standart belgelerine ve belgelendirme kapsamındaki ürünlere www.eca.com.tr, www.valf.com.tr üzerinden ulaşılabilir. SİRKÜLER NO: S1920101

ODA TERMOSTATI

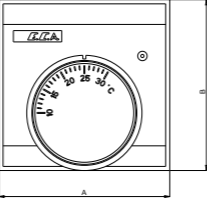
ÜRÜN	ÜRÜN KODU	ÜRÜN ADI	TEKNİK ÇİZİM	LİSTE FİYATI ₺	ÜRÜN KT. AD.											
	601 021 030	MEKANİK ODA TERMOSTATI 10°C-30°C		115	5											
	601 021 033	MEKANİK ODA TERMOSTATI MIN. 15-30°C		115	5											
	601 021 031	DİJİTAL ODA TERMOSTATI ANKASTRE-DUVAR İÇİ HAZNELİ • 220/240 V, 50/60Hz		351	5											
		<table border="1"> <thead> <tr> <th>Kod. No</th> <th>A</th> <th>B</th> </tr> </thead> <tbody> <tr> <td>601 021 030</td> <td>83</td> <td>83</td> </tr> <tr> <td>601 021 033</td> <td>83</td> <td>83</td> </tr> <tr> <td>601 021 031</td> <td>88</td> <td>88</td> </tr> </tbody> </table>	Kod. No	A	B	601 021 030	83	83	601 021 033	83	83	601 021 031	88	88		
Kod. No	A	B														
601 021 030	83	83														
601 021 033	83	83														
601 021 031	88	88														

KOLLEKTÖR ASKI SETİ (YERDEN ISITMA)

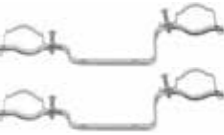
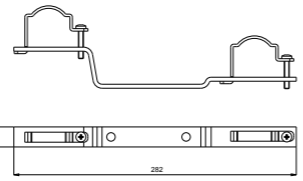
ÜRÜN	ÜRÜN KODU	ÜRÜN ADI	TEKNİK ÇİZİM	LİSTE FİYATI ₺	ÜRÜN KT. AD.
	610 212 003	1" DEBİMETRELİ VE AKTÜATÖR BAĞLANTILI KOLLEKTÖRLER İÇİN ASKI SETİ • Duvar sabitleme vidaları hariçtir.		46	10

HAVA/SU BOŞALTMA SETİ

ÜRÜN	ÜRÜN KODU	ÜRÜN ADI	TEKNİK ÇİZİM	LİSTE FİYATI ₺	ÜRÜN KT. AD.
	602 399 746	HAVA/SU BOŞALTMA SETİ KIRMIZI VOLAN		138	10
	602 399 747	HAVA/SU BOŞALTMA SETİ MAVİ VOLAN • Otomatik Havalandırıcı, Mini Küresel Valf, Tee, Redüksiyon Tapa • Max. Çalışma Sıcaklığı: +80°C • Max. Çalışma Basınç: 10 bar		138	10

RAKORLU KÜRESEL VALF

ÜRÜN	ÜRÜN KODU	ÜRÜN ADI	TEKNİK ÇİZİM	LİSTE FİYATI ₺	ÜRÜN KT. AD.
	102 122 205	1" RAKORLU KÜRESEL VALF KIRMIZI KELEBEK VOLANLI		106	15
	102 122 347	1" RAKORLU KÜRESEL VALF MAVİ KELEBEK VOLANLI • PN 16 • Max. Çalışma Sıcaklığı: +80°C • Max. Çalışma Basınç: 10 bar		106	15

TERMOKUPL ÇIKIŞLI RAKORLU KÜRESEL VALF

ÜRÜN	ÜRÜN KODU	ÜRÜN ADI	TEKNİK ÇİZİM	LİSTE FİYATI ₺	ÜRÜN KT. AD.
	602 122 157	1" TERMOKUPL ÇIKIŞLI RAKORLU KÜRESEL VALF • PN 16 • Max. Çalışma Sıcaklığı: +80°C • Max. Çalışma Basınç: 10 bar		111	15

PEX BAĞLANTI RAKOR GRUBU (YERDEN ISITMA)

ÜRÜN	ÜRÜN KODU	ÜRÜN ADI	TEKNİK ÇİZİM	LİSTE FİYATI ₺	ÜRÜN KT. AD.
	602 199 343	1/2" X Ø16X2 MM PEX BAĞLANTI RAKOR GRUBU		22	80

KOLLEKTÖR KÖR TAPASI (YERDEN ISITMA)

ÜRÜN	ÜRÜN KODU	ÜRÜN ADI	TEKNİK ÇİZİM	LİSTE FİYATI ₺	ÜRÜN KT. AD.
	602 199 121	1" KOLLEKTÖR KÖR TAPASI		17	90

• Fiyatlara KDV ayrıca dahil edilir. Tavsiye edilen bayi satış fiyatıdır.

• Standart belgelerine ve belgelendirme kapsamındaki ürünlere www.eca.com.tr, www.valf.com.tr üzerinden ulaşılabilir. SİRKÜLER NO: S1920101

YANGIN SİSTEMLERİ

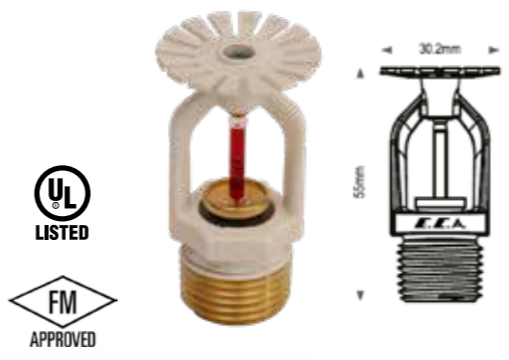
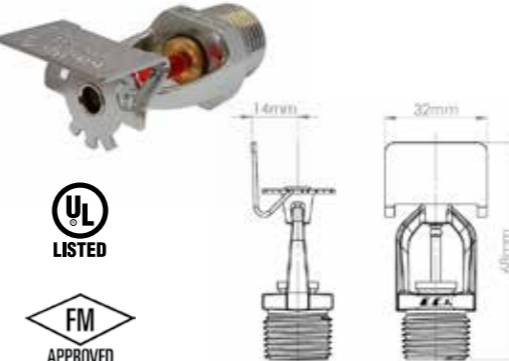
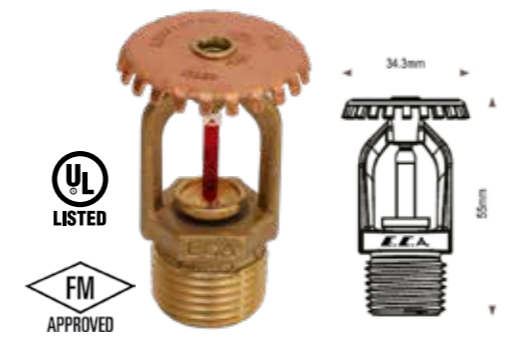
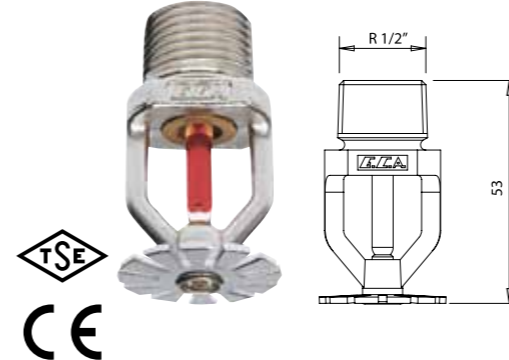

SPRİNKLER

ÜRÜN	ÜRÜN KODU	ÜRÜN ADI	LİSTE FİYATI
	602 112 048 (ST)	TAVAN TİPİ SPRİNKLER (SARKIK-PENDENT) Pirinç 68 °C	10,80 \$
	602 112 049 (HT)	Pirinç 68 °C	13,30 \$
	602 112 044 (ST)	Beyaz 68 °C	13,30 \$
	602 112 045 (HT)	Beyaz 68 °C	15,90 \$
	602 112 056 (ST)	Krom 68 °C	12,70 \$
	602 112 057 (HT)	Krom 68 °C	15,30 \$
	<ul style="list-style-type: none"> • K Faktör(1 bar basınçta): K5,6(US) -K80(SI) • 1/2" NPT bağlantılı • Cam Tüp: 5mm(ST) -3mm(HT) 		
	602 112 050 (ST)	DUVAR TİPİ SPRİNKLER (SIDEWALL) Pirinç 68 °C	19,20 \$
	602 112 051 (HT)	Pirinç 68 °C	20,60 \$
	602 112 052 (ST)	Beyaz 68 °C	21,90 \$
	602 112 053 (HT)	Beyaz 68 °C	23,20 \$
	602 112 058 (ST)	Krom 68 °C	21,10 \$
	602 112 059 (HT)	Krom 68 °C	22,60 \$
	<ul style="list-style-type: none"> • K Faktör(1 bar basınçta): K5,6(US) -K80(SI) • 1/2" NPT bağlantılı • Cam Tüp: 5mm(ST) -3mm(HT) 		
	602 112 046 (ST)	DİK TİP SPRİNKLER (UPRIGHT) Pirinç 68 °C	10,80 \$
	602 112 047 (HT)	Pirinç 68 °C	13,30 \$
	602 112 054 (ST)	Krom 68 °C	12,70 \$
	602 112 055 (HT)	Krom 68 °C	15,30 \$
	<ul style="list-style-type: none"> • K Faktör(1 bar basınçta): K5,6(US) -K80(SI) • 1/2" NPT bağlantılı • Cam Tüp: 5mm(ST) -3mm(HT) 		
	602 112 008 (ST)	TAVAN TİPİ SPRİNKLER (SARKIK-PENDENT) Nikel 68 °C	46 ₺
	602 112 015 (ST)	Nikel - Krom 68 °C	46 ₺
	602 112 016 (ST)	Beyaz Boyalı 68 °C	55 ₺
	602 112 023 (ST)	Kumlu 68 °C	44 ₺
	<ul style="list-style-type: none"> • K Faktör(1 bar basınçta): K5,6(US) -K80(SI) • 1/2" NPT bağlantılı • Cam Tüp: 5mm(ST) -3mm(HT) 		





ST: Standart Tepkimeli HT: Hızlı Tepkimeli

• Fiyatlara KDV ayrıca dahil edilir. Tavsiye edilen bayi satış fiyatıdır.

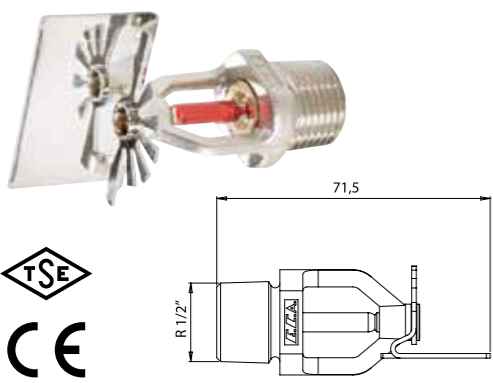

• Standart belgelerine ve belgelendirme kapsamındaki ürünlere www.eca.com.tr, www.valf.com.tr üzerinden ulaşılabilir.

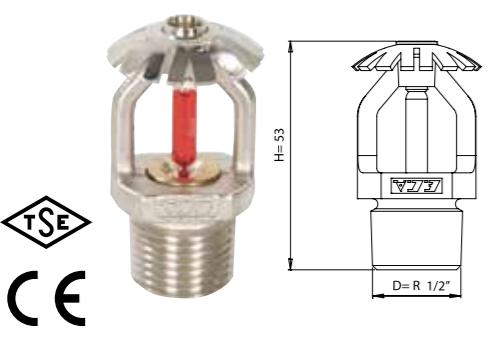
SİRKÜLER NO: S1920101

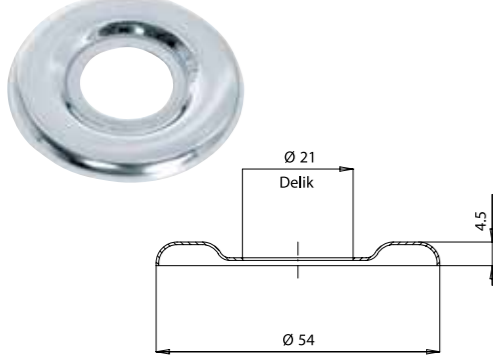
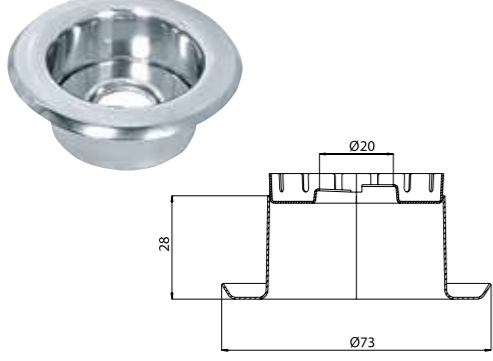

SPRİNKLER

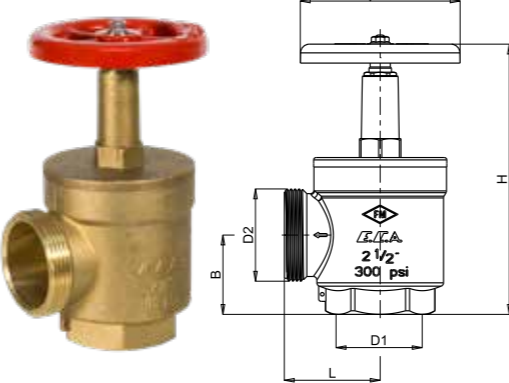
ÜRÜN	ÜRÜN KODU	ÜRÜN ADI	LİSTE FİYATI
 		DUVAR TİPİ SPRİNKLER (SIDEWALL)	
	602 112 013 (ST)	Nikel 68 °C	55 ₺
	602 112 017 (ST)	Nikel - Krom 68 °C	55 ₺
	602 112 018 (ST)	Beyaz Boyalı 68 °C	63 ₺
	602 112 032 (ST)	Kumlu 68 °C	54 ₺
		<ul style="list-style-type: none"> • K Faktör(1 bar basınçta): K5,6(US) -K80(SI) • 1/2" NPT bağlantılı • Cam Tüp: 5mm(ST) -3mm(HT) 	
 		DİK TİP SPRİNKLER (UPRIGHT)	
	602 112 019 (ST)	Nikel 68 °C	46 ₺
	602 112 020 (ST)	Nikel - Krom 68 °C	46 ₺
	602 112 021 (ST)	Beyaz Boyalı 68 °C	55 ₺
	602 112 022 (ST)	Kumlu 68 °C	44 ₺
		<ul style="list-style-type: none"> • K Faktör(1 bar basınçta): K5,6(US) -K80(SI) • 1/2" NPT bağlantılı • Cam Tüp: 5mm(ST) -3mm(HT) 	
	602 299 965	Nikel	8,20 ₺
	602 299 966	Beyaz Boyalı	13 ₺
	602 299 967	Nikel	21 ₺
	602 299 968	Beyaz	30 ₺

İTFAİYE KAT BAĞLANTI VANASI

ÜRÜN	ÜRÜN KODU	ÜRÜN ADI	LİSTE FİYATI												
 	601 014 004	İTFAİYE KAT BAĞLANTI VANASI, 2 1/2"	1.507 ₺												
			<ul style="list-style-type: none"> • Köşe Tip, • Stop salmastralı, Sınırlayıcısız • Max. çalışma basıncı 300 psi 												
		<table border="1"> <thead> <tr> <th>D1</th> <th>D2</th> <th>L</th> <th>B</th> <th>A</th> <th>H</th> </tr> </thead> <tbody> <tr> <td>NPT 2 1/2"</td> <td>2 1/2"-7.5</td> <td>81</td> <td>67</td> <td>Ø135</td> <td>Closed: 227 mm Opened: 272 mm</td> </tr> </tbody> </table>	D1	D2	L	B	A	H	NPT 2 1/2"	2 1/2"-7.5	81	67	Ø135	Closed: 227 mm Opened: 272 mm	
D1	D2	L	B	A	H										
NPT 2 1/2"	2 1/2"-7.5	81	67	Ø135	Closed: 227 mm Opened: 272 mm										

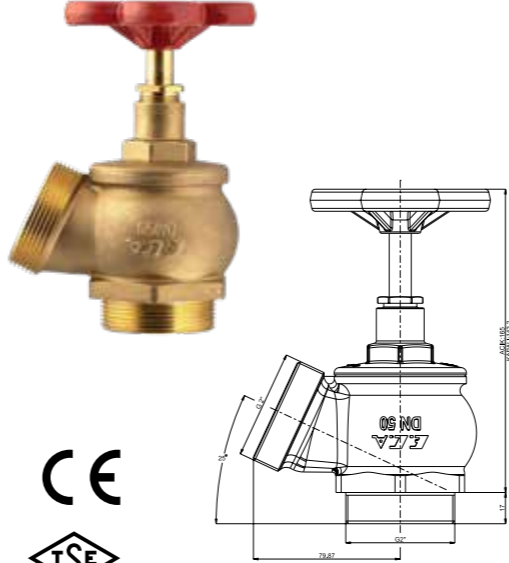
YANGIN DOLAP VANASI

ÜRÜN	ÜRÜN KODU	ÜRÜN ADI	LİSTE FİYATI
 	601 014 001	YANGIN VANASI, 2"	321 ₺
			<ul style="list-style-type: none"> • TS 12259 • Köşe Tip, • Stop salmastralı, Sınırlayıcısız • PN16 • Çıkış 2" Dış Vida

*Farklı sıcaklık değerleri için E.C.A. Üretici-Satış şirketi ile görüşebilirsiniz.

• Standart belgelerine ve belgelendirme kapsamındaki ürünlere www.eca.com.tr, www.valf.com.tr üzerinden ulaşılabilir.
 • Katalogda yer alan resimler bilgi içindir. Elmor Tesisat Malzemeleri Tic. A.Ş. mamul fiyat ve görünüş detaylarında değişiklik yapma hakkına sahiptir.

• Fiyatlara KDV ayrıca dahil edilir. Tavsiye edilen bayi satış fiyatıdır.

• Standart belgelerine ve belgelendirme kapsamındaki ürünlere www.eca.com.tr, www.valf.com.tr üzerinden ulaşılabilir.
 SİRKÜLER NO: S1920101

TEST VE DRENAJ VANASI

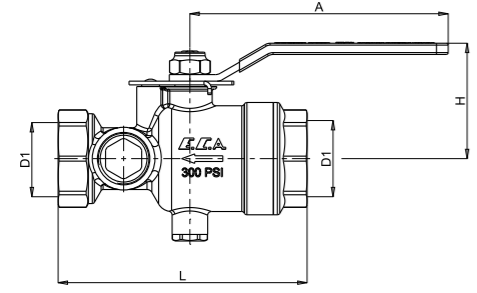
ÜRÜN	ÜRÜN KODU	ÜRÜN ADI	LİSTE FİYATI								
	601 027 073	TEST DRENAJ VANASI, 1 1/4" <table border="1"> <thead> <tr> <th>D1</th> <th>L</th> <th>H</th> <th>A</th> </tr> </thead> <tbody> <tr> <td>NPT 1 1/4"</td> <td>133</td> <td>62</td> <td>138</td> </tr> </tbody> </table> <ul style="list-style-type: none"> Kapalı, Test, Boşaltma Konumlu Orifis çapı 1/2" Max. çalışma basıncı 300 psi 	D1	L	H	A	NPT 1 1/4"	133	62	138	817 ₺
D1	L	H	A								
NPT 1 1/4"	133	62	138								
	601 027 109	TEST DRENAJ VANASI, 1" <table border="1"> <thead> <tr> <th>D1</th> <th>L</th> <th>H</th> <th>A</th> </tr> </thead> <tbody> <tr> <td>NPT 1 1"</td> <td>133</td> <td>62</td> <td>138</td> </tr> </tbody> </table> <ul style="list-style-type: none"> Kapalı, Test, Boşaltma Konumlu K 5,6 Max. çalışma basıncı 300 psi 	D1	L	H	A	NPT 1 1"	133	62	138	808 ₺
D1	L	H	A								
NPT 1 1"	133	62	138								

KÜRESEL VALFLER

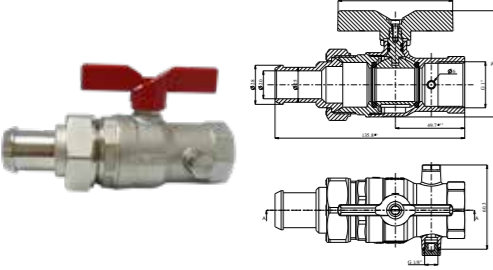
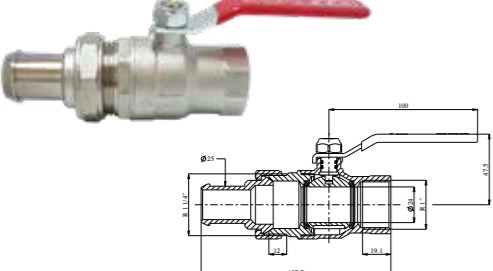
ÜRÜN	ÜRÜN KODU	ÜRÜN ADI	LİSTE FİYATI
	602 122 174	KÜRESEL VALF 1' PN16 HORTUM UÇLU MANOMETRE BAĞLANTILI <ul style="list-style-type: none"> PN16 Alüminyum T(kelebek) volan Ø25 Hortum bağlantısı Çift taraflı drenaj imkanı 	212 ₺
	602 122 049	KÜRESEL VALF 1' PN16 HORTUM UÇLU <ul style="list-style-type: none"> PN16 Ø25 Hortum bağlantısı 	181 ₺

NOTLAR:

NOTLAR:

NOTLAR:

NOTLAR:

GENEL DAĞITIM

ELMOR TESİSAT MALZEMESİ TİCARET A.Ş.

Merkez

Kemeraltı Cad. Ümmehan No: 17/2 Karaköy/İSTANBUL
Tel: (0 212) 705 51 00 Faks: (0 212) 249 90 91
www.eca.com.tr elmor@elmor.com.tr

İstanbul Bölge Müdürlüğü

Kemeraltı Cad. Ümmehan
No: 17/2 Karaköy / İSTANBUL
Tel: (0212) 705 51 00
Faks: (0212) 249 90 91

Ankara Bölge Müdürlüğü

Turan Güneş Blv. No:67
1 Yıldız - Çankaya / ANKARA
Tel: (0312) 490 04 54
Faks: (0312) 490 04 45

İzmir Bölge Müdürlüğü

Gaziler Cad. Yenişehir İş Merkezi
No:478/106 Yenişehir / İZMİR
Tel: (0232) 458 34 34 -458 33 33 Faks:
(0232) 469 82 30

Adana Bölge Müdürlüğü

Adnan Kahveci Bulvarı Mahfesiğmaz Mah.
Tekdal Apt.
No:13 Asma Kat Çukurova / ADANA Tel:
(0322) 234 00 50 (pbx)
Faks: (0322) 234 00 76

Antalya Bölge Müdürlüğü

Gebizli Mah. Termessos Bulvarı
50A/8(302) BY Plaza A Blok
Muratpaşa / ANTALYA
Tel: (0242) 313 09 03
Faks: (0242) 312 63 20

Bursa Bölge Müdürlüğü

Altınşehir Mah. Ata Bulvarı Gizemler
Plaza 3 No:5 Kat:4 D:30 Nilüfer / BURSA
Tel: (0224) 453 1 3 70 -453 15 70 Faks:
(0224) 453 16 05

Trabzon Bölge Müdürlüğü

2 Nolu Beşerli Mah. Devlet Sahil Yolu
Cad. No:186/7 Ortahisar/TRABZON
Tel : (0462) 223 25 00-01
Fax : (0462) 223 61 22

Konya İrtibat Bürosu

Ulaş Baba Cad. Medrese Mah. Mustafa
Kaya İş Merkezi No:24/401 Selçuklu /
KONYA
Tel: (0332) 236 60 68
Faks: (0332) 236 60 52

Samsun İrtibat Bürosu

Bahçelievler Mah.
İstiklal Cad. Oran Apt.
No:194/3 SAMSUN
Tel: (0362) 435 74 30
Faks: (0362) 435 74 34

Diyarbakır İrtibat Bürosu

Yılmaz Güney Cad. Ünsa-1 Sitesi B
Blok 1 /1 Diclekent
Kayapınar / DİYARBAKIR
Tel: (0412) 257 40 33
Faks: (0412) 257 40 34

Kayseri İrtibat Bürosu

Gevher Nesibe Mah. İstasyon Cad. Soylu
İş Merkezi Kat:1 No:41/8 Kocasinan /
KAYSERİ
Tel: (0352) 231 86 18

TEŞHİR ve GALERİLER

İstanbul Elmor Plus

Erenköy Mahallesi Şemsettin
Günaltay Cad. No:207/17-18 Güler
Apt. Kadıköy
Tel: (0216) 445 67 93

İzmir Elmor Plus

Şahitler Cad.
No:141 -A Alsancak/ İZMİR
Tel: (0232) 422 42 23-28

SATIŞ SONRASI SERVİS



EMAR SATIŞ SONRASI MÜŞTERİ HİZMETLERİ SANAYİ ve TİCARET A.Ş.

Emar Servis Müdürlüğü

İstanbul Bölge Servis Şefliği

Esentepe Mahallesi Kasap Sokak No:15/Turan Güneş Blv. No:67/2
34394 Şişli/İSTANBUL
Tel: (0212) 370 13 22
Fax: (0212) 370 13 23

Ankara Bölge Servis Şefliği

Yıldız -Çankaya / ANKARA
Tel: (0312) 492 04 47
Faks: (0312) 491 04 28

İzmir Bölge Servis Şefliği

1348 Sok. Keremoglu İş Merkezi No:2/E
Yenişehir / İZMİR
Tel: (0232) 458 23 51 - 449 06 51 Faks:
(0232) 449 06 52

Antalya Bölge Servis Şefliği

Gebizli Mah. Termessos Bulvarı
50A/8(302) BY Plaza A Blok
Muratpaşa / ANTALYA
Tel: (0242) 313 09 03
Faks: (0242) 312 63 20

www.emarservis.com.tr

emar@emarservis.com.tr



www.eca.com.tr

GENEL DAĞITIM

Elmor Tesisat Malzemesi Ticaret A.Ş.

Tel: (0212) 705 51 00

elmor@elmor.com.tr

YETKİLİ SERVİS

Emar Satış Sonrası Müşteri Hizmetleri San. Tic. A.Ş.

Tel: (0212) 370 13 22

emar@emarservis.com.tr

