

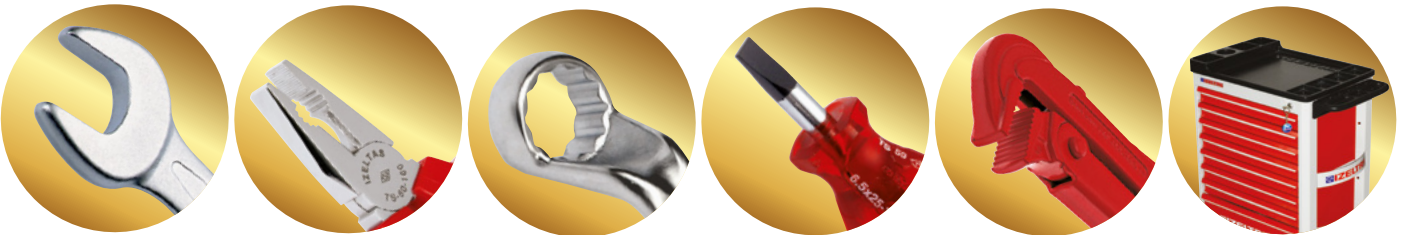

**WIZELTAS®**

**Aralık/2018**  
**FİYAT KATALOĞU**



Fiyatlarımıza KDV dahil değildir.



**IZELTAS**<sup>®</sup>

*“50 yıldır aileden biri”*

[www.izeltas.com.tr](http://www.izeltas.com.tr)



[b2b.izeltas.com.tr](http://b2b.izeltas.com.tr)

**Her platformda  
Bir tık kadar yakınınızda...**





İZELTAŞ - SÜTÇÜLER



İZELTAŞ - TURGUTLU



## Yarım asırlık 'güven'

### Kalite yolculuğu inanmakla başlar.

Türkiye'nin ilk ve en büyük el aletleri üreticisi İZELTAŞ, tam 50 yıl önce Ege'nin gözbebeği İzmir'den işte bu inançla yola çıktı. Yüzde 100 Türk sermayesiyle oluşturulan ve günden güne büyüyen İZELTAŞ, modern teknolojiyle donatılmış dev tesislerinde üretilen dört bin beş yüz den fazla ürünle 40 ülkeye ihracat yaparak hem kendi insanına hem de ülke ekonomisine katkı sağlıyor.

El aletlerinin yanı sıra üretilen dövme parçalar ile başta otomotiv olmak üzere inşaat, denizcilik ve madencilik sektörüne, savunma ve havacılık sanayilerine, ziraat endüstrisine, altyapı işlerine dek birçok kamu ve özel sektör kuruluşuna hizmet sunuyor.

### Daha iyisi, daha yenisi için...

Kalıphane, dövme, işleme, ısıtma işlemi, krom-nikel kaplama, boyama, plastik daldırma, plastik enjeksiyon ve markalama departmanlarından oluşan dünyadaki ender entegre fabrikalardan İZELTAŞ'ta üretimin her aşamasında kalite kontrolüne tabi tutulan ürünler; fiziksel, metalürjik, kimyasal ve elektriksel testlerden geçirilerek İZELTAŞ güvencesine alınıyor. Ar-Ge ve inovasyon ışığında değişime ve gelişime her daim açık olan İZELTAŞ, bu sayede gücüne güç katıyor.

T.C. Sanayi ve Teknoloji Bakanlığ'ından AR-GE Merkezi belgesine sahip İZELTAŞ, TS EN ISO 9001 Kalite Yönetim Sistemi, IATF 16949 Otomotiv Kalite Yönetim Sistemi, TS (OHSAS) 18001 İş Sağlığı ve Güvenliği Yönetim Sistemi, TS EN ISO 14001 Çevre Yönetim Sistemi, TS EN ISO 50001 Enerji Yönetim Sistemleri; TSE, TSEK, VDE GS ürün kalite belgeleri ve yüksek teknolojisi ile sadece Türkiye'de değil, dünyada da farkını ortaya koyuyor.

### Önce güvenlik, sonra üretim

İnsan önemli, emek değerlidir. İZELTAŞ, "Önce güvenlik" anlayışından ayrılmadan, çalışanları için önlem almaya, onları iş sağlığı ve güvenliği konusunda eğitmeye devam ediyor. Çünkü; "İnsan vücudunun yedek parçası yoktur"

### Size ulaştıktan sonra...

Satış sonrasında tüketici haklarını koruma ve sınırsız hizmet anlayışı İZELTAŞ'ın vazgeçilmez şirket politikalarından birini oluşturuyor.

### Dolayısıyla...

- El aletleri' dendiğinde akla gelen ilk isim olabildiysek,
- Yarım asırdır 'aileden biri' olmanın hakkını verebildiysek,
- 'Türk malı' sözünün altına imzamız atabildiysek,
- 'Yıllarca kullanılır' diyerek her zaman tercih edildiysek,

Gücümüzü, şevkimizi ve inancımızı siz değerli bayilerimiz ve tüketicilerimizden alıyoruz.

850 çalışanımızla birlikte üreterek, değer sağlayarak dünya markası olmanın haklı gururunu yaşıyoruz.

Nice 50 yıllara!

## Half a century of reliability

### Faith is the essential step on the journey to achieve utmost quality.

As the first and largest hand tool manufacturer of Turkey, İZELTAŞ, had this faith as it started its journey 50 years ago in İzmir, the beautiful city in the Aegean region. Its establishment, consisting of 100% national capital, İZELTAŞ has grown in years into an industrial giant with huge facilities equipped with state-of-the-art technologies and over 4500 products. Exporting to more than 40 countries, the company is a prominent contributor to not only the Turkish economy but also the community.

Along with manufacturing hand tools, İZELTAŞ produces forged steel parts for various industries like automotive, construction, maritime, mining, aviation, defence, agriculture and infrastructure.

### Newer and better

İZELTAŞ is one of the few fully integrated factories in the world that consists of die tooling, forging, processing, heat processing, chrome-nickel plating, dyeing, pvc coating, plastic injection and marking departments. Every stage of the production is tested for quality assurance using physical, metallurgical, chemical and electrical methods. R&D and innovation are the key words that empower İZELTAŞ as a company which embraces development and improvement as its main philosophy.

İZELTAŞ is an accredited R&D Center by the Ministry of Science, Industry and Technology and has been certified with the following: ISO 9001 Quality Management System, IATF 16949 Automotive Quality Management System, OHSAS 18001 Occupational Health and Safety Management System, ISO 14001 Environment Management System, ISO 50001 Energy Management System certification, TSE, TSEK and VDE GS product certification.

### Safety before production

Humans are the most significant factors of any industry and their labour is precious. Health and safety awareness is the fundamental policy of İZELTAŞ. The company continuously organizes training programs on occupational health and safety which emphasise that safety comes first and it is not possible to fix humans by changing the damaged organs with spare ones.

### Customer satisfaction

Another fundamental policy of İZELTAŞ is the customer satisfaction. The company is dedicated to serve its customers and protect their rights as consumers.

### Hence...

- We are the first brand that comes to mind in the hand tools industry
- We are valued almost as a part of the families of our consumer
- We have proved ourselves worthy of the statement "Made in Turkey"
- We have been the first choice of the consumers for durability over the years

Our power, enthusiasm and faith are derived from our distinguished dealers and consumers.

We are proud to have become a world brand with our 850 employees who strive everyday to contribute to the productivity of the company, creating an added value for the economy and our community.

To many 50 years to come!

**Takım Dolapları ve Takım Çantaları**  
Tool Trolleys, Tool Boxes



7-38

1

**Anahtarlar**  
Wrenches



41-60

2

**Lokma ve Bijon Anahtarları**  
Sockets and Rim Wrenches



61-84

3

**Boru Anahtarları ve Penseler**  
Pipe Wrenches and Pliers



85-98

4

**1000V Grubu Ürünler**  
1000V Product Group



99-102

5

**Tornavida ve Allen Anahtarlar**  
Screwdrivers and Hex Key Wrenches



103-123

6

**Keskiler ve Çekiçler**  
Chisels and Hammers



125-130

7

**Servis Alet ve Ekipmanları**  
Maintenance Tools and Equipment



131-138

8

**Makaslar**  
Shears



139-144

9

**Çektirmeler**  
Pullers



145-150

10

**DIY Elta Tools**



151-162

11

**Yedek Parçalar**  
Spare Parts



163-166

12

**Ticari Teşhir Standları**  
Commercial Display Stands



167-170

13

**Stoklarla Sınırlı Ürünler**  
Limited Items



171-188

14

**Teknik Bilgiler**  
Technical Information



190-198

15



1

# Takım Dolapları Takım Çantaları ve Alet Setleri Tool Trolleys, Tool Boxes and Hand Tool Sets



*Takım Dolapları* Tool Cabinets

*Takım Çantaları* Tool Boxes

*Servis Masaları* Service Tables

*Alet Setleri* Tool Sets



**ZELTAS**



## 8241 PRO SERİSİ / PRO SERIES

### Pro Serisi Takım Dolabı ( 5-6-7-8 Çekmeceli ) Pro Series Workshop Trolley ( 5-6-7-8 Drawers )



Ölçü/Size: 470x670x1006 mm

Sacdan imal edilmiş, Fırın boyalı  
Made of sheet metal, Electrostatic paint

✓ Merkezi kilit sistemi, mandal sistemi ve devrilme emniyet sistemi.  
● Central lock system, handgrip lock system and antitilt system.



✓ Teleskobik rulmanlı kızaklar tüm çekmeceler %100 açılabilir.  
● Telescopic slides which are %100 extendable.



✓ 8 bölmeli sağlam ve dayanıklı ABS plastik üst malzeme tabla.  
● Durable ABS worktop with 8 divisions

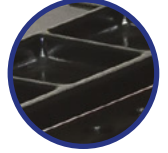

✓ 2 sabit, 2 hareketli frenli tekerlek Ø 125mm  
● 2 swivel castors with brake, 2 fixed castors Ø 125mm



✓ Yüksek dayanımlı elektrostatik toz boya.  
● High strength electrostatic powder coating



✓ Toplam 6 Adet yan ve arka avadanlık bölümleri.  
● 6 tool holders



KOD/CODE	ÇEKMECE DRAWERS	35 kg	45 kg	45 kg	kg	RENK COLORS	FİYAT TL/Ad
		400x548x68	400x548x143	400x548x218			
8241 32 1005	5	1X	4X	--	59		2404,00
8241 32 1006	6	4X	1X	1X	62	RAL 7035	2597,75
8241 32 1007	7	5X	2X	--	65	RAL 3020	3069,90
8241 32 1008	8	7X	1X	--	67		3272,40
8241 32 2005	5	1X	4X	--	59		2404,00
8241 32 2006	6	4X	1X	1X	62	RAL 7035	2597,75
8241 32 2007	7	5X	2X	--	65	RAL 5003	3069,90
8241 32 2008	8	7X	1X	--	67		3272,40
8241 32 3005	5	1X	4X	--	59		2404,00
8241 32 3006	6	4X	1X	1X	62	RAL 7035	2597,75
8241 32 3007	7	5X	2X	--	65	RAL 7035	3069,90
8241 32 3008	8	7X	1X	--	67	RAL 7016	3272,40
8241 00 1209 Dolu/Full 209 Parça/Pcs	8	7x	1x	--			7896,85

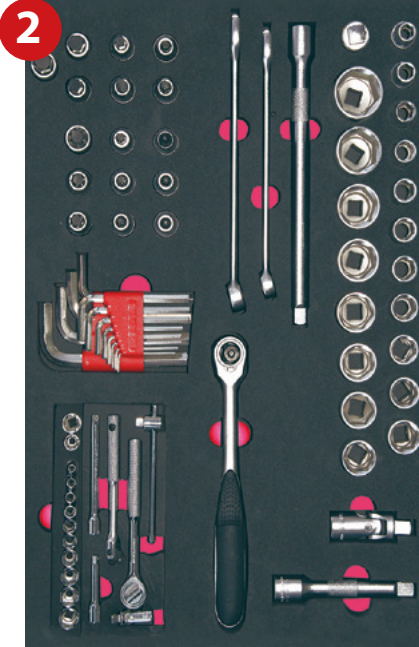
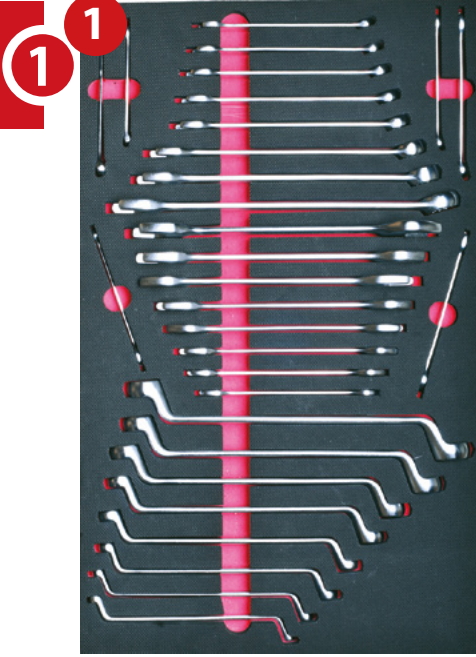

## 1. Pro Seri Çekmece/Drawer

Kod / Code 8241001030

KOD CODE	İÇERİK CONTENTS		FİYAT TL/Ad
0130	<b>İki Ağız Anahtar Uzun Boy / D/E Open Jaw Wrench Long Pattern</b> 6x7 - 8x9 - 10x11 - 12x13 14x15 - 16x17 - 18x19 - 20x22 21x23 - 24x26	10	
0330	<b>Kombine Anahtar Uzun Boy / Combination Wrench Long Pattern</b> 6 - 7 - 8 - 9 - 10 - 11 - 12 - 13 14 - 17 - 19 - 22	12	584,80
0430	<b>Yıldız Anahtar / D/E Ring Wrench</b> 6x7 - 8x9 - 10x11 - 12x13 14x15 - 16x17 18x19 - 20x22	8	

## 2. Pro Seri Çekmece/Drawer

Kod / Code 8241002072

KOD CODE	İÇERİK CONTENTS		FİYAT TL/Ad
1107	<b>1/4" Karbüratör Lokma Takımı / 1/4" Socket Wrench Set</b> 4 - 5 - 6 7 - 8 - 9 - 10 11 - 12 - 13 <b>Altı Köşe</b> Six Point 8 - 10 <b>Sekiz Köşe</b> Eight Points	18	
1113	<b>1/2" Lokma Takımı / 1/2" Socket Wrench Set</b> 10 - 11 - 12 13 - 14 - 15 16 - 17 - 18 19 - 21 - 22 23 - 24 - 26 27 - 28 - 30 32	24	1393,10
1113	<b>1/2" Lokmalı Allen Uçlar / 1/2" Hexagonal Bits Sockets</b> H5-H6-H7-H8-H10-H12-H14	7	
1113	<b>1/2" Lokmalı Star Uç / 1/2" Star Bits Socket</b> T20-T25-T27-T30-T40-T45-T50-T55-T60	9	
0330	<b>Kombine Anahtar Uzun Boy / Combination Wrench Long</b> 16-18 mm	2	
4900	<b>Allen Takımı 6 Köşe / Hex Key Wrench Set</b> 2-2.5-3-3.5-4-5-6-7-8-9-10-12	12	

## 3. Pro Seri Çekmece/Drawer

Kod / Code 8241003051

KOD CODE	İÇERİK CONTENTS		FİYAT TL/Ad
07415	<b>Sıralı Tel Fırça 3 Sıralı / Hand Brush 3 Raws</b>	1	
6350	<b>Levye Oluklu / Tyre Lever</b> 400 mm	1	
6220	<b>Spiralli Mıknatıs / Flexible Magnet Holder</b> 500 gr	1	
4110	<b>Düz Topaç Tornavida / Screwdriver , Stubby, Flat</b> 6.5x25	1	
4130	<b>Yıldız Topaç Tornavida / Screwdriver , Stubby, Phillips</b> 6x25	1	528,60
4770	<b>Lokma Uçlu Tornavida / Nutspinner</b> 6-7-8-9-10-13	6	
4780	<b>Manyetik Bits Tutucu Tornavida / Screwdriver, Magnetic Bit Holder</b> 6.3x120	1	
4905	<b>Yuvarlak Başlı Allen Takımı (Kutulu) / Hexkey Wrench Ballpoint Set</b> 2-2.5-3-4-5-6-8-10 mm	8	
4800	<b>Bits Set Takım (Kutulu) / Bits Set in metal case</b>	31	

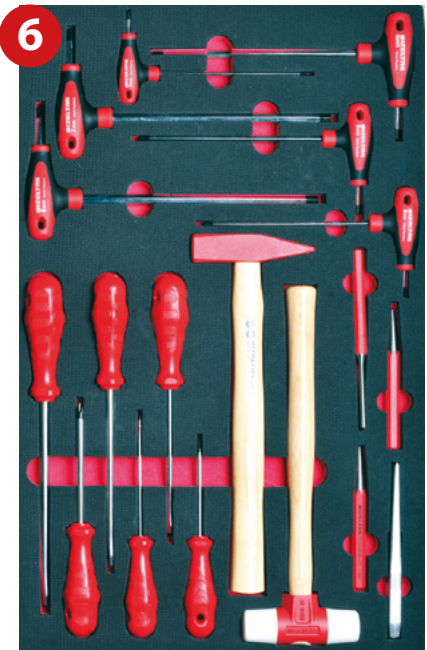

#### 4. Pro Seri Çekmece/Drawer

Kod / Code 8241004027

KOD CODE	İÇERİK CONTENTS	□	FİYAT TL/Ad
0340	<b>Cırcır Kombine Anahtar / Combination Wrench With Ratchet</b> 10-13-17-19 mm	4	
4909	<b>T Tipi Torx Allen Anahtar / Torx Allen Key T type</b> T9-T10-T15-T20-T25-T27-T30-T40	8	
1108	<b>1/2" Altı Köşe Derin Lokma / 1/2" Deep Socket Wrench, six points</b> 10-11-12-13-14-15-16-17-18-19	10	921,65
1113	<b>1/2" Altı Köşe Havalı Lokma / 1/2" Impact Socket Wrench</b> 13-17-18-19-24 mm	5	

#### 5. Pro Seri Çekmece/Drawer

Kod / Code 8241005010

KOD CODE	İÇERİK CONTENTS	□	FİYAT TL/Ad
3331	<b>İç Eğri Segman Pense / Circlip Pliers, Internal, Bent 170 mm</b>	1	
3321	<b>İç Düz Segman Pense / Circlip Pliers, Internal, Flat 180 mm</b>	1	
3311	<b>Dış Eğri Segman Pense / Circlip Pliers, External, Bent 170 mm</b>	1	
3301	<b>Dış Düz Segman Pense / Circlip Pliers, External, Flat 180 mm</b>	1	
3700	<b>Yan Keski Opak İzole / Side Cutting Pliers, 160 mm</b>	1	771,65
3220	<b>Düz Kargaburun Opak İzole / Nose Pliers, 200 mm</b>	1	
3020	<b>Kombine Pense Opak İzole / Combination Pliers, 180 mm</b>	1	
2510	<b>Special Ayarlı Pense / Special Grip 250 mm</b>	1	
0600	<b>Kurbağacık Anahtar / Adjustable Jaw Wrench 10"</b>	1	
2400	<b>Üniversal Fort Pense / Universal Grip 240 mm</b>	1	

#### 6. Pro Seri Çekmece/Drawer

Kod / Code 8241006018

KOD CODE	İÇERİK CONTENTS	□	FİYAT TL/Ad
4300	<b>Opak Seri Düz Uçlu Tornavida / Opak Screwdriver, Flat</b> 4x100-5x125-6x150-8x175	4	
4320	<b>Opak Seri Yıldız Uçlu Tornavida / Opak Screwdriver, Phillips</b> 4.5x80-6x100	2	
5800	<b>Tesviyeci Çekiç / Mechanist Hammer 300 gr</b>	1	
5850	<b>Plastik Çekiç / Plastic Hammer ø30</b>	1	424,60
5545	<b>Konik Pim Zimba / Drift Punch 5 mm</b>	1	
5550	<b>Düz Pim Zimba / Split Pin Punch 5 mm</b>	1	
5540	<b>Nokta Zimba / Center Punch 5x120</b>	1	
5500	<b>Düz Keski / Flat Cold Chisel 150 mm</b>	1	
4920	<b>T Tipi Allen Anahtar / T Type Hex Key Wrench 3-4-5-6-7-8</b>	6	



## 8245 PREMIUM SERİSİ / PREMIUM SERIES

### Premium Serisi Takım Dolabı ( 5-7 Çekmeceli ) Premium Series Workshop Trolley ( 5-7 Drawers )



✓ 6 bölmeli sağlam ve dayanıklı ABS plastik üst malzeme tabla.  
● Resistant and solid top cover having 6 divisions

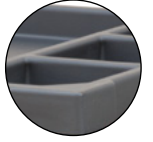

✓ %100 açılabilir teleskopik raylar.  
● %100 extendable telescopic slides



✓ Merkezi kilit  
✓ Mandal sistemi  
✓ Devrilme emniyet sistemi  
● Central lock  
● Handgrip Lock system  
● Anti tilt system



✓ 2 sabit, 2 hareketli frenli tekerlek ø 125mm  
● 2 swivel castors with brake  
2 fixed castors ø 125mm



✓ Standard tutma sapı  
● Standard handle



✓ Plastik köşe koruma  
● Plastic corner protection

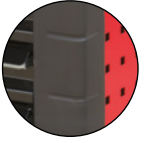

✓ Yüksek dayanımlı elektrostatik toz boya.  
● High strength electrostatic powder coating.

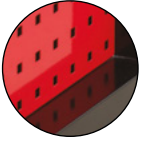

Ölçü/Size: 495x717x947

Sacdan imal edilmiş, Fırın boya  
Made of sheet metal, Electrostatic paint



KOD/CODE	ÇEKMECE DRAWERS	400x548x62	400x548x132	400x548x201	Kg	RENK COLORS	FİYAT TL/Ad
8245 32 1005	5	2	1	2			2325,00
8245 32 1007	7	5	1	1		RAL 9005 RAL 3020	3010,00
8245 00 7096 Dolu/Full	7	5	1	1			8824,40

1



2

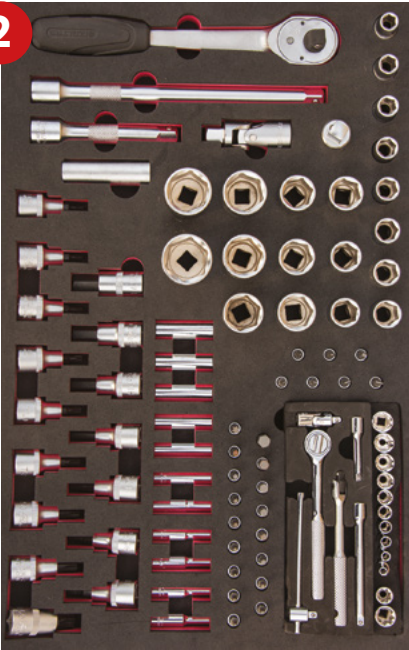

3



### 1. Premium Seri Çekmece/Drawer Kod / Code 8245001042

KOD CODE	İÇERİK CONTENTS	□	FIYAT TL/Ad
0100	<b>İki Ağız Anahtar Kısa Boy</b> D/E Open jaw wrenches Short Pattern 6x7-8x9-10x11-12x13-14x15-16x17-18x19-20x22	8	
0320	<b>Kombine Anahtar Kısa Boy</b> Combination wrenches Short Pattern 6-7-8-9-10-11-12-13-14-15-16-17-18-19-20-21-22-24-27-30-32	21	1118,00
0430	<b>Yıldız Anahtar</b> Ring Wrenches 6x7-8x9-10x11-12x13-14x15-16x17-18x19-20x22	8	
0340	<b>Cırcır Kombine Anahtar / Combination Wrench With Ratchet</b> 8-10-13-17-19 mm	5	

### 2. Premium Seri Çekmece/Drawer Kod / Code 8245002094

KOD CODE	İÇERİK CONTENTS	□	FIYAT TL/Ad
1107	<b>1/4" Lokmalı Allen Uçlar / Hexagonal Bits Socket</b> 2,5 - 3 - 4 - 5 - 6 - 7 - 8 - 10	8	
1107	<b>1/4" Lokmalı Torx Uç / Torx Bits Socket</b> T8-T9-T10-T15-T20-T25-T27-T30-T40	9	
1107	<b>1/4" Lokmalı Yıldız Uç / Phillips Bits Socket</b> PH1-PH2-PH3	3	
1107	<b>1/4" Lokmalı Düz Uç / Slotted Bits Socket</b> 3 - 4 - 5,5 - 6,5	4	
1107	<b>1/4" Altı Köşe Derin Lokma / Deep Socket Wrench 6 Point</b> 4-5-5,5-6-7-8-9-10-11-12-13	11	
1113	<b>1/2" Lokmalı Allen Uç Takım / Hexagonal Bits Socket</b> 5-6-7-8-10-12-14	7	
1113	<b>1/2" Lokmalı Torx Uç Takım / Torx Bits Socket</b> T20-T25-T27-T30-T40-T45-T50-T55-T60	9	
1107	<b>1/4" Karbüratör Lokma Takımı / Socket Wrench Set</b> 4 - 5 - 6 7 - 8 - 9 - 10 11 - 12 - 13 <b>Altı Köşe</b> Six Points 8 - 10 <b>Sekiz Köşe</b> Eight Points	18	1438,25
1113	10 - 11 - 12 - 13 14 - 15 16 - 17 - 18 19 - 21 - 22 23 - 24 - 26 - 27 28 - 30 32 <b>Altı Köşe</b> Six Points	24	

### 3. Premium Seri Çekmece/Drawer Kod / Code 8245003014

KOD CODE	İÇERİK CONTENTS	□	FIYAT TL/Ad
3700	<b>Yan Keski Opak İzole / Side Cutting Pliers 160 mm</b>	1	
3020	<b>Kombine Pense Opak İzole / Combination Pliers 180 mm</b>	1	
3220	<b>Düz Kargaburun Opak İzole / Nose Pliers Flat 180 mm</b>	1	
4300	<b>Opak Seri Düz Uçlu Tornavida / Screwdriver, Flat</b> 3x80-5x125-7x150mm	3	
4320	<b>Opak Seri Yıldız Uçlu Tornavida / Screwdriver, Philips</b> 3x60-4.5x80-6x100-8x150mm	4	576,85
3301	<b>Dış segman Pensi Yaylı Düz / Circlip Pliers, External Flat</b> 140-180mm	2	
3321	<b>İç segman Pensi Yaysız Düz / Circlip Pliers, Internal Flat</b> 140-180mm	2	

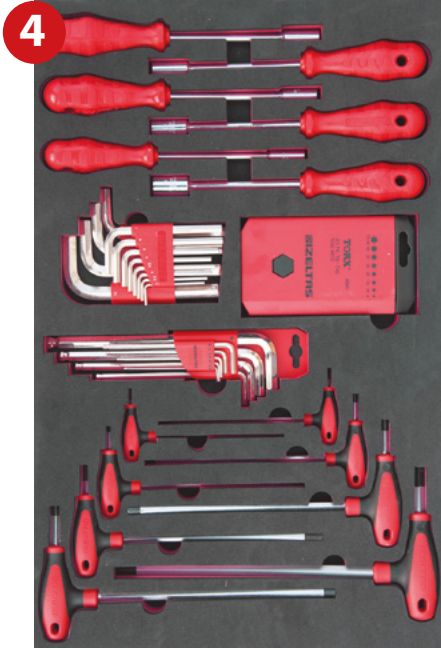

#### 4. Premium Seri Çekmece/Drawer Kod / Code 8245004043

KOD CODE	İÇERİK CONTENTS	□	FIYAT TL/Ad
4770	<b>Lokma Uçlu Tornavida / Nutspinner</b> 6-7-8-9-10-13	6	651,85
4910	<b>Torx Allen Takım / Torx Key Wrench Set</b> T9-T10-T15-T20-T25-T27-T30-T40	8	
4900	<b>Allen Takımı 6 Köşe / Hex Key Wrench Set</b> 2-2.5-3-3.5-4-5-6-7-8-9-10-12	12	
4906	<b>Yuvarlak Başlı Uzun Allen Takımı / Hex key Wrench Ballpoint Long Pattern Set</b> 2-2.5-3-4-5-6-8-10 mm	9	
4920	<b>T Tipi Allen Anahtar / T Type Hex Key Wrench</b> 2.5-3-4-5-6-7-8-10	8	

#### 5. Premium Seri Çekmece/Drawer Kod / Code 8245005043

KOD CODE	İÇERİK CONTENTS	□	TL/Ad.
4565	<b>Oto Elektrik Kontrol Kalemi</b> Car Voltage Tester 135mm	1	729,30
07415	<b>Sıralı Tel Fırça 4 Sıralı / Hand Brush 4 Raws</b>	1	
2400	<b>Üniversal Fort Pense PVC / Universal Grip 240 mm</b>	1	
2500	<b>Üniversal Ayarlı Pense</b> Universal Grip 250 mm	1	
0600	<b>Kurbağacık Anahtar / Adjustable Wrench 10"</b>	1	
4780	<b>Manyetik Bits Tutucu Tornavida / Screwdriver, Magnetic Bit Holder</b> 6.3x120	1	
4800	<b>31'li Bits Takım (Plastik Kutulu) / Bits Set in plastic case</b>	31	
4110	<b>Düz Topaç Tornavida / Screwdriver , Stubby, Flat 6.5x25</b>	1	
4130	<b>Yıldız Topaç Tornavida / Screwdriver , Stubby, Phillips 6x25</b>	1	
5500	<b>Düz Keski Krom</b> Flat Cold Chisel 150 mm	1	
5800	<b>Tesviyeci Çekici</b> Machinist's Hammer 300-1500 gr	2	
6350	<b>Levye Oluklu / Tyre Lever 500 mm</b>	1	

#### 6. Premium Seri Çekmece/Drawer Kod / Code 8245006009

KOD CODE	İÇERİK CONTENTS	□	FIYAT TL/Ad
1855	<b>Mafsallı T Kol Lokma</b> T- Handle Wrench with Universal Join 8-10-12-13-17-19	6	1300,10
6230	<b>Gres Pompası</b> Grease Gun 500cc	1	
06375	<b>Ayarlı Yağ Filtre Sökeceği</b> Adjustable Slot Type Oil Filter Wrench	1	
6225	<b>Madeni Yağdanlık (Flexible Uçlu)</b> Oiler With Flexible Spout 200cc	1	





## 8242 GARAJ SERİSİ / GARAGE SERIES

Garaj Serisi Takım Dolabı ( 5-6-7-8 Çekmeceli )  
Garage Series Workshop Trolley ( 5-6-7-8 Drawers )



✓ Ergonomik sap  
● Ergonomic handle



✓ 8 Bölmeli, sağlam ABS tabla  
● Durable ABS worktop with divisions



✓ Havluluk x1  
Avadanlık x2 Askılık x1  
● Paper Roll Holder  
x1 Bottle & Tins Holder x2 Hanger x1



✓ %100 açılabilir teleskobik raylar  
● %100 extendable telescopic slides



✓ Merkezi kilit sistemi, mandal sistemi devrilme emniyet sistemi.  
● Central locking, system handgrip lock system anti-tilt system

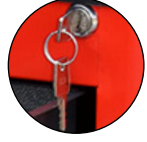

✓ 2 sabit, 2 hareketli frenli tekerlek Ø 125mm  
● 2 swivel castors with brake 2 fixed castors Ø 125 mm



✓ Yüksek dayanımlı elektrostatik toz boya.  
● High strength electrostatic powder coating

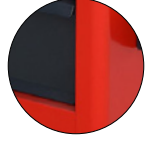

Ölçü/Size: 470x670x1008 mm

Sacdan imal edilmiş, Fırın boya  
Made of sheet metal, Electrostatic paint



RAL 7016  
RAL 3020

RAL 7016  
RAL 5003

RAL 7016  
RAL 7035

KOD/CODE	ÇEKMECE DRAWERS	35 kg	45 kg	45 kg	kg	RENK COLORS	FİYAT TL/Ad
		400x548x68	400x548x143	400x548x218			
8242 32 1005	5	1X	4X	--	59		2148,05
8242 32 1006	6	4X	1X	1X	62	RAL 7016 RAL 3020	2528,35
8242 32 1007	7	5X	2X	--	65		2954,15
8242 32 1008	8	7X	1X	--	67		3243,00
8242 32 2005	5	1X	4X	--	59		2148,05
8242 32 2006	6	4X	1X	1X	62	RAL 7016 RAL 5003	2528,35
8242 32 2007	7	5X	2X	--	65		2954,15
8242 32 2008	8	7X	1X	--	67		3243,00
8242 32 3005	5	1X	4X	--	59		2148,05
8242 32 3006	6	4X	1X	1X	62	RAL 7016 RAL 7035	2528,35
8242 32 3007	7	5X	2X	--	65		2954,15
8242 32 3008	8	7X	1X	--	67		3243,00
8242 00 1142 Dolu/Full 142 Parça/Pcs	7	5X	2X	--			6470,35
8242 00 8142 Dolu/Full 142 Parça/Pcs	8	7X	1X	--			6759,20



## 1. Garaj Seri Çekmece/Drawer

Kod / Code 8242001030

KOD CODE	İÇERİK CONTENTS	□	FİYAT TL/Ad
0130	<b>İki Ağız Anahtar Uzun Boy</b> D/E Open Jaw Wrench Long Pattern 6x7 - 8x9 - 10x11 - 12x13 14x15 - 16x17 - 18x19 - 20x22 - 21x23 - 24x26	10	
0330	<b>Kombine Anahtar Uzun Boy</b> Combination Wrenches Long Pattern 6 - 7 - 8 - 9 - 10 - 11 - 12 - 13 - 14 - 17 - 19 - 22	12	584,80
0430	<b>Yıldız Anahtar</b> Ring Wrench 6x7 - 8x9 - 10x11 - 12x13 - 14x15 - 16x17 18x19 - 20x22	8	

## 2. Garaj Seri Çekmece/Drawer

Kod / Code 8242002072

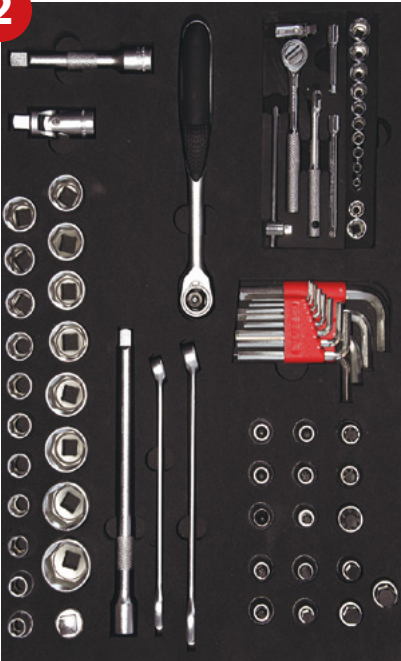

KOD CODE	İÇERİK CONTENTS	□	FİYAT TL/Ad
1113	<b>1/2" Lokmalı Allen Uçlar</b> Hexagonal Bits Socket H5-H6-H7-H8-H10-H12-H14	7	
1113	<b>1/2" Lokmalı Star Uç / 1/2 Star Bits Socket</b> T20-T25-T27-T30-T40-T45-T50-T55-T60	9	
0330	<b>Kombine Anahtar Uzun Boy</b> Combination Pliers Long 16-18 mm	2	
4900	<b>Allen Takımı 6 Köşe / Hex Key Wrench Set</b> 2-2.5-3-3.5-4-5-6-7-8-9-10-12	12	
1107	<b>1/4" Karbüratör Lokma Takımı</b> Socket Wrench Set <b>1/4" Cırcır Kolu</b> Ratchet Handle 4 - 5 - 6 7 - 8 - 9 - 10 11 - 12 - 13 <b>Altı Köşe</b> Six Points 8 - 10 <b>Sekiz Köşe</b> Eight Points	18	1393,10
1113	<b>1/4" Mafsal</b> Universal Joint <b>1/4" T Kol / Sliding T Handle</b> <b>1/4" Ara Kol / Extension Bar 54 mm</b> <b>1/4" Ara Kol</b> Extension Bar 100 mm <b>1/4" Mafsalı Kol</b> Flexible Handle <b>1/2" Lokma Takımı</b> Socket Wrench Set <b>1/2" Cırcır Kolu 72 Diş</b> Ratchet Handle (Max Gear) <b>1/2" Mafsal</b> Universal Joint <b>1/2" T Kol Adaptör</b> Sliding T Handle Adapter <b>1/2" Ara Kol</b> Extension Bar 125 mm <b>1/2" Ara Kol</b> Extension Bar 250 mm	24	

3



### 3. Garaj Seri Çekmece/Drawer

Kod / Code 8242003010

KOD CODE	İÇERİK CONTENTS	☐	FİYAT TL/Ad
3331	<b>İç Eğri Segman Pense</b> Circlip Pliers Internal (Bent) 170 mm	1	771,65
3321	<b>İç Düz Segman Pense</b> Circlip Pliers Internal (Flat) 180 mm	1	
3311	<b>Dış Eğri Segman Pense</b> Circlip Pliers External (Bent) 170 mm	1	
3301	<b>Dış Düz Segman Pense</b> Circlip Pliers External (Flat) 180 mm	1	
3700	<b>Yan Keski Opak İzole</b> Side Cutting Pliers 160 mm	1	
3220	<b>Düz Kargaburun Opak İzole</b> Nose Pliers (Flat) 200 mm	1	
3020	<b>Kombine Pense Opak İzole</b> Combination Pliers 180 mm	1	
2510	<b>Special Ayarlı Pense / Universal Grip</b> 250 mm	1	
0600	<b>Kurbağacık Anahtar / Adjustable Wrench</b> 10"	1	
2400	<b>Üniversal Fort Pense / Waterpump Pliers</b> Üniversal 240 mm	1	

1

4



### 4. Garaj Seri Çekmece/Drawer

Kod / Code 8242004018

KOD CODE	İÇERİK CONTENTS	☐	FİYAT TL/Ad
4300	<b>Opak Seri Düz Uçlu Tornavida</b> Screwdriver, Opak Flat 5x125-4x100-6x150-8x175	4	424,60
4320	<b>Opak Seri Yıldız Uçlu Tornavida</b> Screwdriver, Opak Phillips 4.5x80-6x100	2	
5800	<b>Tesviyeci Çekiç</b> Machinist's Hammer 300 gr	1	
5850	<b>Plastik Çekiç</b> Plastic Hammer ø30	1	
5545	<b>Konik Pim Zimba</b> Drift Punch 5 mm	1	
5550	<b>Düz Pim Zimba</b> Split Pin Punch 5 mm	1	
5540	<b>Nokta Zimba</b> Center Punch 5x120	1	
5500	<b>Düz Keski</b> Flat Cold Chisel 150 mm	1	
4920	<b>T Tipi Allen Anahtar / Hex Key Wrench</b> 3-4-5-6-7-8	6	

5

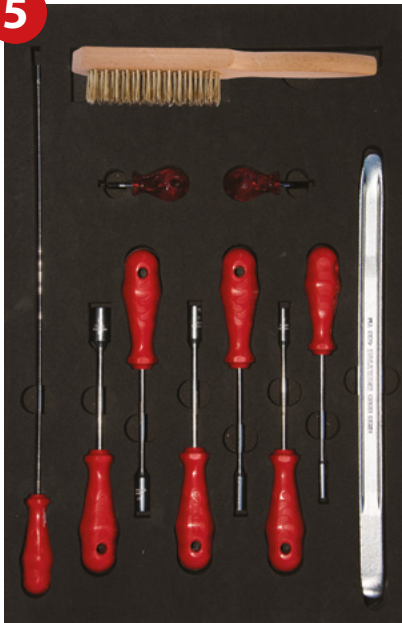

### 5. Garaj Seri Çekmece/Drawer

Kod / Code 8242005011

KOD CODE	İÇERİK CONTENTS	☐	FİYAT TL/Ad
07415	<b>Sıralı Tel Fırça 3 Sıralı</b> Hand Brush 3 Raws	1	342,05
6350	<b>Levye Oluklu</b> Tyre Lever, Straight 400 mm	1	
6220	<b>Spiralli Miknatis</b> Flexible Magnet Holder 500 gr	1	
4110	<b>Düz Topaç Tornavida</b> Screwdriver Stubby Flat 6.5x25	1	
4130	<b>Yıldız Topaç Tornavida</b> Screwdriver Stubby Phillips 6x25	1	
4770	<b>Lokma Uçlu Tornavida</b> Nut Spinner 6-7-8-9-10-13	6	

1



## 8235 PARTNER SERİSİ / PARTNER SERIES

1

Partner Mobil Takım Dolabı ( 5 Çekmeceli )  
Partner Workshop Trolley ( 5 Drawers )



✓ Merkezi kilit.  
● Central lock system



✓ %100 açılabilir, kendinden frenli teleskobik ray  
● %100 extendable telescopic soft close slides



✓ 8 Bölmeli, sağlam ABS tabla  
● 8 Durable ABS worktop with divisions



✓ 2 sabit, 2 hareketli frenli tekerlek ø 100mm  
● 2 swivel castors with brake  
2 fixed castors ø 100 mm



✓ Yüksek dayanımlı elektrostatik toz boya.  
● High strength electrostatic powder coating

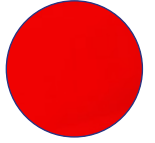

Ölçü/Size: 470x670x975 mm

Sacdan imal edilmiş, Fırın boya  
Made of sheet metal, Electrostatic paint



KOD/CODE	ÇEKMECE DRAWERS	35 kg	45 kg	kg	RENK COLORS	FİYAT TL/Ad
		350x550x75	400x550x180			
8235 32 6005	5	3X	2X	56	RAL 3020	1954,30
8235 32 5005	5	3X	2X	56	RAL 5003	1954,30
8235 32 7005	5	3X	2X	56	RAL 9005	1954,30
8235 00 6121 Dolu/Full 121 Parça/Pcs	5	3X	2X			4497,75



## 1. Partner Seri Çekmece/Drawer

Kod / Code 8235001072

KOD CODE	İÇERİK CONTENTS	□	FİYAT TL/Ad
1107	<p><b>1/4" Karbüratör Lokma Takımı</b> 1/4" Socket Wrench Set</p> <p><b>1/4" Cırcır kolu</b> Ratchet Handle</p> <p><b>1/4" Mafsal</b> Universal Joint</p> <p>4 - 5 - 6 7 - 8 - 9 - 10 11 - 12 - 13 <b>Altı Köşe</b> Six Points</p> <p>8 - 10 <b>Sekiz Köşe</b> Eight Points</p>	18	
1113	<p><b>1/4" Mafsalı Kol</b> Flexible Handle</p> <p><b>1/2" Lokma Takımı</b> 1/2" Socket Set</p> <p><b>1/2" Cırcır Kolu 32 Diş</b> Ratchet Handle</p> <p><b>1/2" Mafsal</b> Universal Joint</p> <p>10 - 11 - 12 - 13 14 - 15 16 - 17 - 18 19 - 21 - 22 23 - 24 - 26 - 27 - 28 30 - 32</p> <p><b>1/2" T Kol Adaptör</b> Sliding T Handle Adapter</p> <p><b>1/2" Ara Kol</b> Extention Bar 125 mm</p> <p><b>1/2" Ara Kol</b> Extention Bar 250 mm</p>	24	1411,30
1507	<p><b>1/4" Derin Lokma Tornavida Adaptörü</b> Spindle Handle</p>	1	
4900	<p><b>12 'li Allen Anahtar Takımı</b> Hex Key Wrench Set 2-2.5-3-3.5-4-5-6-7-8-9-10-12 mm</p>	12	
4910	<p><b>8 'li Torx Allen Anahtar Takımı</b> Torx Key Wrench 6 Point T9-T10-T15-T20-T27-T25-T30-T40</p>	8	
1108	<p><b>1/2" Altı Köşe Derin Lokma</b> Deep Socket Wrench 6 Point 10-13-16-17-18-19 mm</p>	6	
1113	<p><b>1/2" 16 mm Buji Lokma Anahtar</b> Spark Plug Socket With Rubber</p>	1	
2400	<p><b>240 mm Üniversal Fort Pense</b> Waterpump Pliers, Universal</p>	1	
2500	<p><b>250 mm Üniversal Ayarlı Pense</b> Universal Grip</p>	1	

2

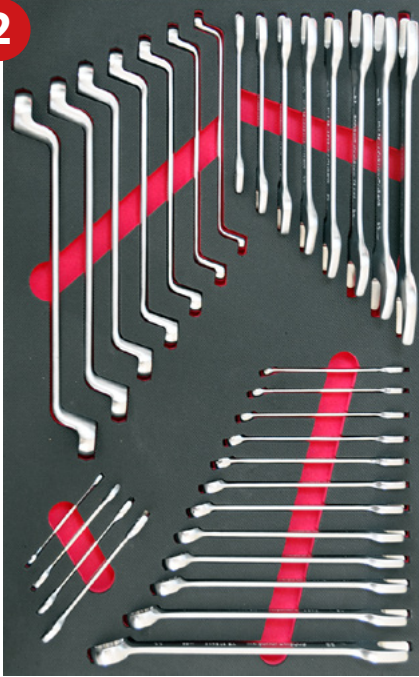

## 2. Partner Seri Çekmece/Drawer

Kod / Code 8235002031

KOD CODE	İÇERİK CONTENTS	□	FİYAT TL/Ad
0100	<b>İki Ağız Anahtar Kısa Boy</b> Double Ended Open Jaw Wrench Short Pattern 6x7 - 8x9 - 10x11 - 12x13 14x15 - 16x17 - 18x19 - 20x22 21x23 - 24x26 - 25x28 - 30x32	12	
0320	<b>Kombine Anahtar Kısa Boy</b> Combination Wrench Short Pattern 8 - 9 - 10 - 11 - 12 - 13 14 - 15 - 16 - 17 - 19 - 22	12	579,85
0430	<b>Yıldız Anahtar</b> Ring Wrench 8x9 - 10x11 - 12x13 - 14x15 - 16x17 18x19 - 20x22	7	

1

3



## 3. Partner Seri Çekmece/Drawer

Kod / Code 8235003017

KOD CODE	İÇERİK CONTENTS	□	FİYAT TL/Ad
4300	<b>Opak Seri Düz Uçlu Tornavida</b> Screwdriver, Opak Flat 3x80-4x80-4x100-5x125-6x150	5	
4320	<b>Opak Seri Yıldız Uçlu Tornavida</b> Screwdriver, Opak Phillips 4.5x80-6x100	2	
3700	<b>Yan Keski Opak İzole</b> Side Cutting Pliers 160 mm	1	
3020	<b>Kombine Pense Opak İzole</b> Combination Pliers 180 mm	1	552,30
3220	<b>Düz Kargaburun Opak İzole</b> Nose Pliers Flat 200 mm	1	
4770	<b>Lokma Uçlu Tornavida</b> Nut Spinner 6-7-8-10-13	5	
5500	<b>Düz Keski</b> Flat Cold Chisel 150 mm	1	
5800	<b>Çekiç</b> Machinist's Hammer 500 gr	1	



Eko Serisi Takım Dolabı ( 5-7 Çekmeceli )  
Eco Series Workshop Trolley ( 5-7 Drawers )



✓ 4 bölmeli sağlam ve dayanıklı ABS plastik üst malzeme tabla.  
● Resistant and solid top cover with 4 divisions

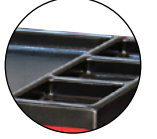

✓ %100 açılabilir teleskobik raylar.  
● %100 extendable telescopic slides



✓ Merkezi kilit  
● Central locking

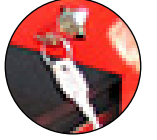

✓ 2 sabit, 2 hareketli frenli tekerlek ø 100 mm  
● 2 swivel castors with brake  
2 fixed castors ø 100 mm



✓ Yüksek dayanımlı elektrostatik toz boya.  
● High strength electrostatic powder coating

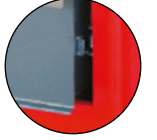

✓ Eloksallı alüminyum tutma çantası.  
● Handle with anodised aluminum

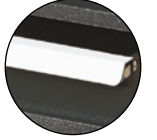

Sacdan imal edilmiş, Fırın boya  
Made of sheet metal, Electrostatic paint

Ölçü/Size: 405x613x894 mm



RAL 7016  
RAL 3020



RAL 7016  
RAL 5003



RAL 7035  
RAL 7016

KOD/CODE	ÇEKMECE DRAWERS	35 kg	45 kg	Kg	RENK COLORS	FİYAT TL/Ad
8243 32 1005	5	3X	2X	43	RAL 7016 RAL 3020	1425,65
8243 32 1007	7	7X	--	43	RAL 7016 RAL 5003	1911,25
8243 32 2005	5	3X	2X	43	RAL 7035 RAL 7016	1425,65
8243 32 2007	7	7X	--	43		1911,25
8243 32 3005	5	3X	2X	43		1425,65
8243 32 3007	7	7X	--	43		1911,25
8243 00 1096 Dolu/Full 96 Parça/Pcs	5	3X	2X			3446,30
8243 00 7096 Dolu/Full 96 Parça/Pcs	7	3x	--			3931,90



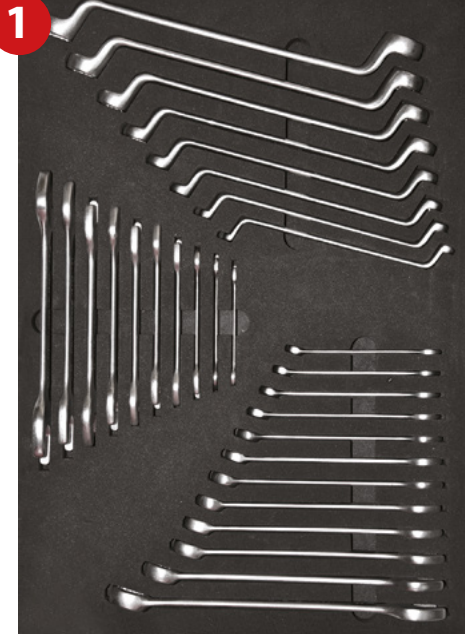

### 1. Eko Seri Çekmece/Drawer

Kod / Code 8243001030

KOD/CODE	İÇERİK CONTENTS	☐	TL/Ad.
0100	<b>İki Ağız Anahtar Kısa Boy</b> D/E Open Jaw Wrench Short Pattern 6x7 - 8x9 - 10x11 - 12x13 14x15 - 16x17 - 18x19 - 20x22 - 21x23 - 24x26	10	
0320	<b>Kombine Anahtar Kısa Boy</b> Combination Wrench Short Pattern 8 - 9 - 10 - 11 - 12 - 13 - 14 - 15 - 16 - 17 - 19 - 22	12	548,60
0430	<b>Yıldız Anahtar</b> Ring Wrench 6x7 - 8x9 - 10x11 - 12x13 - 14x15 - 16x17 18x19 - 20x22	8	



### 2. Eko Seri Çekmece/Drawer

Kod / Code 8243002052

KOD/CODE	İÇERİK CONTENTS	☐	TL/Ad.
1113	<b>1113 1/2" 17'li Lokma Takımı</b> Socket Wrench Set 1/2" mm 10 - 11 - 12 - 13 - 14 - 15 - 17 - 19 22 - 24 - 27 - 30 - 32 250 - 250 - 70	17	
1107	<b>Karbüratör Lokma Takımı</b> Socket Wrench Set 1/4" mm 4 - 5 - 6 - 7 - 8 - 9 - 10 - 11 - 12 - 13 <b>Sekiz köşe / Eight points</b> 8 - 10 140 - 115 - 100 - 50 - 38 - 130	18	921,50
4900	<b>Allen Anahtar Takımı</b> Hex Key Wrench Set 2 - 2.5 - 3 - 3.5 - 4 - 5 - 6 - 7 - 8 - 9 - 10 - 12	12	
4770	<b>Lokma Uçlu Tornavidalar</b> Nutspinners 6 - 7 - 8 - 10 - 13	5	



### 3. Eko Seri Çekmece/Drawer

Kod / Code 8243003013

KOD/CODE	İÇERİK CONTENTS	☐	TL/Ad.
4320	<b>Opak Yıldız Uçlu Tornavida</b> Opak Screwdriver, Phillips 4,5x80-6x100 mm	2	
4300	<b>Opak Düz Uçlu Tornavida</b> Opak Screwdriver, Flat 5x125-4x100-6x150-8x175 mm	4	
3700	<b>Yan Keski Opak</b> Side Cutting Pliers 160 mm	1	
3020	<b>Kombine Pense Opak</b> Combination Pliers 180 mm	1	
3220	<b>Kargaburun Düz Uçlu Opak</b> Nose Pliers, Flat 160 mm	1	550,55
5500	<b>Düz Keski Krom</b> Flat Cold Chisel 150 mm	1	
5800	<b>Tesviyeci Çekici</b> Machinist's Hammer 300 gr	1	
2510	<b>Spesiyel Ayarlı Pense / Waterpump Pliers Special</b> 250 mm	1	
2400	<b>Üniversal Fort Pense PVC / Universal Grip</b> 240 mm	1	

1

Trend Serisi Takım Dolabı ( 5-7 Çekmeceli )  
Trend Series Workshop Trolley ( 5-7 Drawers )



✓ 4 bölmeli sağlam ve dayanıklı ABS plastik üst malzeme tabla.  
● Resistant and solid top cover with 4 divisions

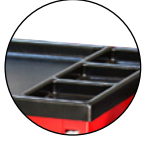

✓ %100 açılabilir teleskobik raylar.  
● %100 extendable telescopic slides



✓ Merkezi kilit  
● Central locking



✓ 2 sabit, 2 hareketli frenli tekerlek ø 100 mm  
● 2 swivel castors with brake  
2 fixed castors ø 100 mm



✓ Yüksek dayanımlı elektrostatik toz boya  
● High strength electrostatic powder coating





✓ Kendiliğinden açılmayı engelleyen plastik kilit  
● Plastic lock preventing self opening



Ölçü/Size: 405x613x894 mm



Sacdan imal edilmiş, Fırın boya  
Made of sheet metal, Electrostatic paint

KOD/CODE	ÇEKMECE DRAWERS	 350x503x82	 400x503x176	 Kg	RENK COLORS	FIYAT TL/Ad
8244 32 1005	5	3X	2X	43	RAL 9005 RAL 3020	1132,70
8244 32 1007	7	7X	--	43		1490,40
8244 00 5096 Dolu/Full 96 Parça/Pcs	5	3X	2X			3153,35
8244 00 7096 Dolu/Full 96 Parça/Pcs	7	7X	--			3511,05

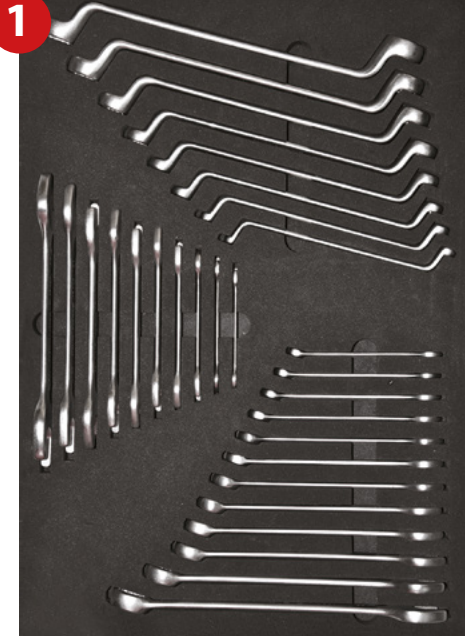

## 1. Trend Seri Çekmece/Drawer Kod / Code 8244001030

KOD/CODE	İÇERİK CONTENTS	☐	TL/Ad.
0100	<b>İki Ağız Anahtar Kısa Boy</b> D/E Open Jaw Wrench Short Pattern 6x7 - 8x9 - 10x11 - 12x13 14x15 - 16x17 - 18x19 - 20x22 - 21x23 - 24x26	10	
0320	<b>Kombine Anahtar Kısa Boy</b> Combination Wrench Short Pattern 8 - 9 - 10 - 11 - 12 - 13 - 14 - 15 - 16 - 17 - 19 - 22	12	548,60
0430	<b>Yıldız Anahtar</b> Ring Wrench 6x7 - 8x9 - 10x11 - 12x13 - 14x15 - 16x17 18x19 - 20x22	8	



## 2. Trend Seri Çekmece/Drawer Kod / Code 8244002052

KOD/CODE	İÇERİK CONTENTS	☐	TL/Ad.
1113	<b>1/2" 17'li Lokma Takımı</b> Socket Wrench Set 1/2" mm 10 - 11 - 12 - 13 - 14 - 15 - 17 - 19 22 - 24 - 27 - 30 - 32 250 - 250 - 70	17	
1150	<b>1/4" Karbüratör Lokma Takımı</b> Socket Wrench Set 1/4" mm 4 - 5 - 6 - 7 - 8 - 9 - 10 - 11 - 12 - 13 <b>Sekiz köşe / Eight points</b> 8 - 10 140 - 115 - 100 - 50 - 38 - 130	18	921,50
4900	<b>Allen Anahtar Takımı</b> Hex Key Wrench Set 2 - 2.5 - 3 - 3.5 - 4 - 5 - 6 - 7 - 8 - 9 - 10 - 12	12	
4770	<b>Lokma Uçlu Tornavidalar</b> Nutspinners 6 - 7 - 8 - 10 - 13	5	



## 3. Trend Seri Çekmece/Drawer Kod / Code 8244003013

KOD/CODE	İÇERİK CONTENTS	☐	TL/Ad.
4220	<b>Opak Yıldız Uçlu Tornavida</b> Opak Screwdriver, Phillips 4.5x80-6x100 mm	2	
4300	<b>Opak Düz Uçlu Tornavida</b> Opak Screwdriver, Flat 5x125-4x100-6x150-8x175 mm	4	
3700	<b>Yan Keski Opak</b> Side Cutting Pliers 160 mm	1	
3020	<b>Kombine Pense Opak</b> Combination Pliers 180 mm	1	550,55
3220	<b>Kargaburun Düz Uçlu Opak</b> Nose Pliers, Flat 160 mm	1	
5500	<b>Düz Keski Krom</b> Flat Cold Chisel 150 mm	1	
5800	<b>Tesviyeci Çekici</b> Machinist Hammer 300 gr	1	
2510	<b>Special Ayarlı Pense / Waterpump Pliers Special</b> 250 mm	1	
2400	<b>Üniversal Fort Pense PVC / Üniversal Grip</b> 240 mm	1	

1

Vagon Serisi Takım Dolabı  
Wagon Series Workshop Trolley



- ✓ 8 Bölmeli, sağlam ABS tabla
- Durable ABS worktop with divisions

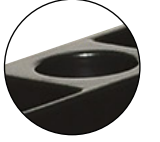

- ✓ Kilit T kol
- Locked T-handle



- ✓ 2 Sabit, 2 hareketli frenli tekerlek ø 125mm
- 2 swivel castors with brake 2 fixed castors ø 125 mm



- ✓ Yüksek dayanımlı elektrostatik toz boya.
- High strength electrostatic powder coating

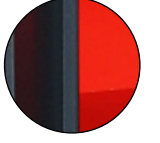

- ✓ 2X ayarlanabilir raf (10 adet seperatör ile)
- 2x adaptable shelves with separator 10 pcs

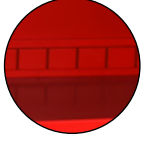

- ✓ Standard tutma sapı
- Standard handle



- ✓ 2X avadanlık
- 2X tin holder

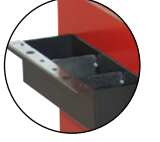

RAL 7016  
RAL 3020

Ölçü/Size: 470x670x970 mm

Sacdan imal edilmiş, Fırın boya  
Made of sheet metal, Electrostatic paint

KOD/CODE	SIZE (mm)	KG	RENK COLORS	FİYAT TL/AD
----------	-----------	----	-------------	-------------

8210 32 6001

470x670x1020

45

RAL 7016  
RAL 3020

1272,55

## 8160 TAKIM DOLABI / TOOL CABINET

Takım Dolabı  
Tool Cabinet



Ölçü/Size: 250x650x1010 mm

Sacdan imal edilmiş, Fırın boya  
Made of sheet metal, Electrostatic paint

✓ Kilit T kol  
● Locked T-handle



✓ %100 açılabilir teleskobik raylar.  
● %100 extendable telescopic slides



✓ 2 hareketli frenli tekerlek ø 50mm  
● 2 swivel castors with brake ø 50 mm



✓ Yüksek dayanımlı elektrostatik toz boya.  
● High strength electrostatic powder coating



✓ Avadanlık x2  
● Bottle and tins holder x2



✓ Askılık x4  
● Hanger x4

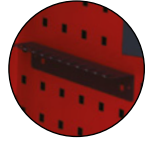

✓ Özel askılık x4  
● Special hanger x4

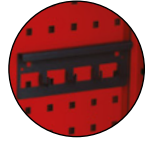

✓ Anahtar askısı x1  
● Hanger for wrenches x1



✓ Özel avadanlık x1  
● Special tin holder x1

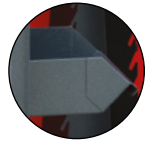

✓ Matkap ucu tutucu x1  
● Drill bits holder x1



RAL 7016  
RAL 3020

KOD/CODE	 200x500x55	SIZE (mm)	 KG	COLORS	FİYAT TL/Ad.
----------	--	-----------	--	--------	--------------

8160 32 6001

3x

228x56758

35

RAL 7016  
RAL 3020

1121,85

**Demonte Mini Servis Arabası**  
*Disassembled Mini Service Trolley*



- **3X Kauçuk Kaydırmaz Mat**  
*3X Rubber Anti Slipping Mats*
- **2X Sabit, 2X Hareketli Frenli Tekerlek (ø 100 mm)**  
*2X Fixed, 2X Swivel Castors with Brake (ø 100 mm)*
- **Sağlam sac metal yapı, Her raf 50 Kg taşır.**  
*Robust sheet-steel construction, Loading capacity per shelf 50 Kg*

Çelik konstrüksiyon  
*Steel construction*

KOD/CODE	 420x590x57	SIZE (mm)	 KG	COLORS	FIYAT TL/Ad.
----------	---	-----------	---	--------	-----------------

8550 34 8001

3x

424x677x822

18

RAL 9005  
RAL 3020

495,15

**Demonte Mini Servis Arabası (kapalı)**  
*Disassembled Mini Service Trolley (closed)*



- **3X Kauçuk Kaydırmaz Mat**  
*3X Rubber Anti Slipping Mats*
- **2X Sabit, 2X Hareketli Frenli Tekerlek (ø 100 mm)**  
*2X Fixed, 2X Swivel Castors with Brake (ø 100 mm)*
- **Sağlam sac metal yapı, Her raf 50 Kg taşır.**  
*Robust sheet-steel construction, Loading capacity per shelf 50 Kg*
- **Arabanın yanları ve arkasında kare askı delikleri**  
*Square-shaped perforation on the side panels and back panel offers individual fastening*

Çelik konstrüksiyon  
*Steel construction*

KOD/CODE	 420x590x57	SIZE (mm)	 KG	COLORS	FIYAT TL/Ad.
----------	---	-----------	---	--------	-----------------

8550 34 8002

3x

424x677x822

23

RAL 9005  
RAL 3020

662,05

8545

Taşıma Arabası  
Platform Wagon

1



- **18mm Plywood Tabla (Kauçuk Mat ile Birlikte)**  
18mm PLYWOOD table ( with rubber mat)
- **2X Sabit, 2X Hareketli Frenli Tekerlek (ø 200mm)**  
2X Fixed, 2X Swivel Castors with Brake (ø 200mm)
- **Sağlam sac metal yapı, Her raf 540 Kg taşır.**  
Robust sheet-steel construction, Loading capacity per shelf 540 Kg

Çelik konstrüksiyon  
Steel construction

KOD/CODE	SIZE (mm)	KG	COLORS	FİYAT TL/Ad.
----------	-----------	----	--------	--------------

8545 34 1005

600x1145x1104

38

RAL 9005

1450,00

8550

Servis Arabası (Büyük Boy)  
Service Trolley (Large Size)



- **3X Kauçuk Kaydırmaz Mat**  
3X Rubber Anti Slipping Mats
- **2X Sabit, 2X Hareketli Frenli Tekerlek (ø 125 mm)**  
2X Fixed, 2X Swivel Castors with Brake (ø 125 mm)
- **Sağlam sac metal yapı, Her raf 75 Kg taşır.**  
Robust sheet-steel construction, Loading capacity per shelf 75 Kg

Çelik konstrüksiyon  
Steel construction

KOD/CODE	75 kg	SIZE (mm)	KG	COLORS	FİYAT TL/Ad.
----------	-------	-----------	----	--------	--------------



494x844x40

8550 34 6001

3x

500x850x935

37

RAL 3020

1028,60

Servis Masası (Panolu)  
Work Bench (With Panel)



- **Merkezi kilit sistemi, mandal sistemi**  
Central locking system, handgrip lock system
- **Kaynaklı sağlam tasarım**  
Robust welded design
- **%100 Açılabilir teleskobik raylar**  
100% extendable telescopic slides
- **Yüksek dayanımlı elektrostatik toz boya.**  
High strength electrostatic powder paint
- **Delikli panel (220 V prizler ile).**  
Perforated panel with electrical plugs 220 V

Çelik Konstrüksiyon ve zor koşullarda çalışmaya elverişli  
Özel Plywood ahşap tezgah  
Strong and durable steel construction and  
Plywood bench

KOD/CODE		SIZE (mm)	 KG	COLORS	FİYAT TL/Ad.
	348x548x90				

8500 34 6001

3x

720x1680x1495

102



2840,00

8501

Servis Masası (Panosuz)  
Work Bench (Without Panel)



- **Merkezi kilit sistemi, mandal sistemi**  
Central locking system, handgrip lock system
- **Kaynaklı sağlam tasarım**  
Robust welded design
- **%100 Açılabilir teleskobik raylar**  
100% extendable telescopic slides
- **Yüksek dayanımlı elektrostatik toz boya.**  
High strength electrostatic powder paint

Çelik konstrüksiyon ve zor koşullarda çalışmaya elverişli  
Özel Plywood ahşap tezgah  
Strong and durable steel construction and Plywood bench

KOD/CODE		SIZE (mm)	 KG	COLORS	FİYAT TL/Ad.
	348x548x90				

8501 34 6001

3x

700x1680x900

84



2070,00



8502

1

Demonte Servis Masası  
Disassembled Work Bench



- **Demonte sağlam tasarım**  
Robust disassembled design
- **18mm Plywood Tabla (Kauçuk mat ile birlikte)**  
18mm Plywood Bench with non-slip rubber insert
- **Ayarlanabilir ayaklar**  
Height adjustable feet
- **İZELTAS Eco ve/veya Trend Dolaplar ile kombine kullanabilme imkanı**  
Can be combined with IZELTAS Eco and Trend Trolley

Çelik konstrüksiyon  
Steel construction

KOD/CODE		SIZE (mm)	 KG	COLORS	FİYAT TL/Ad.
	200x500x55				

8502 34 6001

3x

710x1692x1002

35

RAL 3020

1693,55

Çekmeceli Alet Sandığı  
Tool Chest With Drawers



285x650x322





285x550x322



285x450x322



KOD/CODE	Ölçü Size	ÇEKMECE DRAWERS				FİYAT TL/Ad
8320 33 1003	285x650x322	3x	2x	1x	20	1059,85
8320 33 1002	285x550x322	3x	2x	1x	18	1048,80
8320 33 1001	285x450x322	3x	2x	1x	16	1037,80

8420

Takım Çantası (5 Gözlü)  
Tool Box (5 Trays)

1

195x300x210

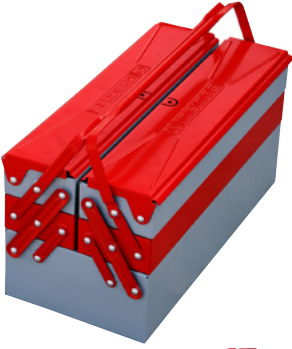

195x420x210

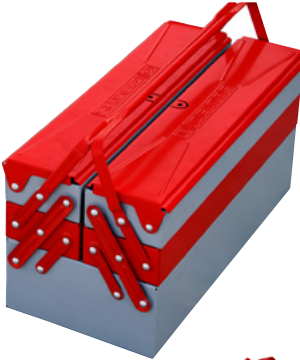

195x520x210

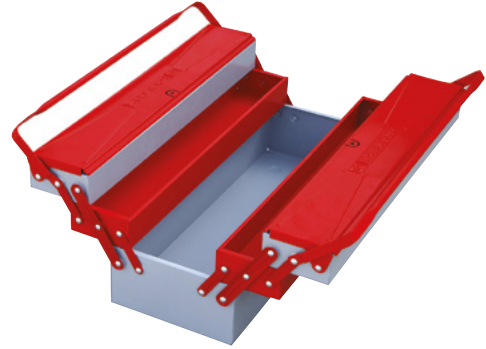
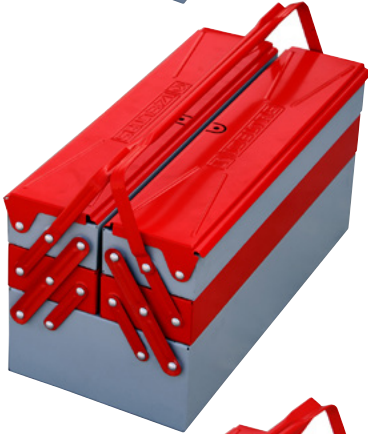

195x600x210

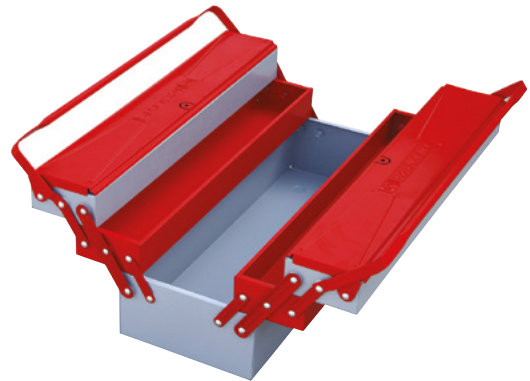
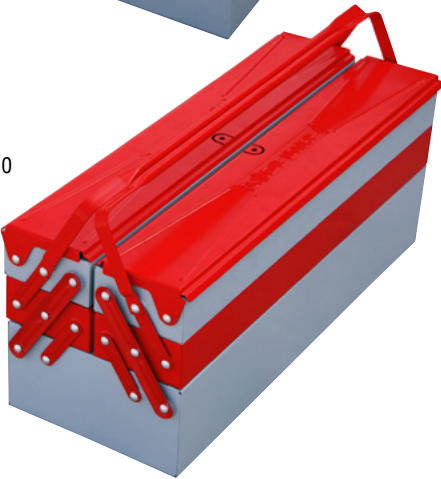

Sacdan imal edilmiş, Fırın boya  
Made from metal sheet, Electrostatic paint

KOD CODE	ÖLÇÜ SIZE mm	g		FİYAT TL/Ad
8420 33 6105	195x300x210	3200	1	119,45
8420 33 6205	195x420x210	4200	1	159,90
8420 33 6305	195x520x210	5000	1	182,20
8420 33 6405	195x600x210	5600	1	197,35

**Takım Çantası (5 Gözlü)**  
*Tool Box (5 Trays)*

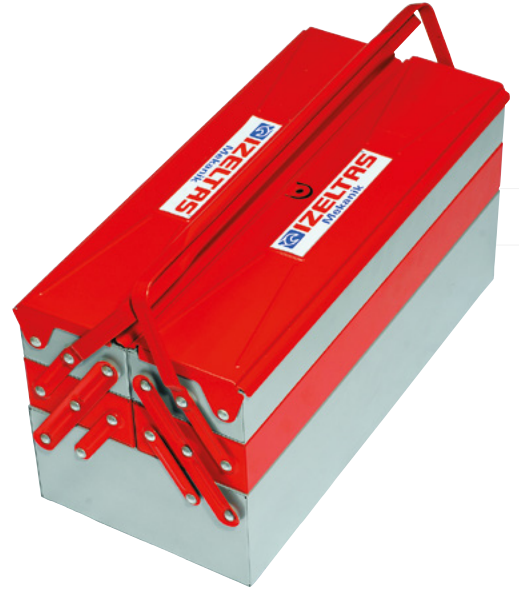

**8420 00 5063**

**Mekanik Takım Çantası (62 Parça, 5 Gözlü)**  
*Tool Box for Mechanician (62 Pcs, 5 Trays)*

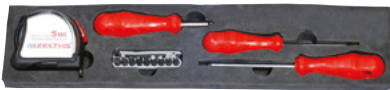

**8420 00 5046**

**Elektrikçi Takım Çantası (45 Parça, 5 Gözlü)**  
*Tool Box for Electrician (45 Pcs, 5 Trays)*



**8420 00 5028**

**Tesisatçı Takım Çantası (28 Parça, 5 Gözlü)**  
*Tool Box for Plumbers (28 Pcs, 5 Trays)*



**8420 00 5063**
**Mekanik Takım Çantası (5 Gözlü)**  
*Tool Box for Mechanician (5 Trays)*

KOD CODE	ÖLÇÜ SIZE mm	TL/Ad.
8420 00 5063	190x420x200 <b>DOLU / FULL</b>	62 1319,60

KOD CODE	İÇERİK CONTENTS	
05881 50 015	<b>5 m Krom Şerit Metre</b> Chrom Case Steel, Measuring tapes	1
4785 19 6330	<b>6.3x30 Kısa Bits Tutucu Tornavida</b> Screwdriver, Magnetic Bit Holder (Short)	1
4800 00 8110	<b>10 'Lu Bits Takım</b> Bits Set 10 (Pcs) 25 mm	1
4320	<b>Yıldız Uçlu Tornavida Opak Seri</b> Screwdriver, Opak, Flat 4.5x80-6x100	2
4300	<b>Düz Uçlu Tornavida Opak Seri</b> Screwdriver, Opak, Philips 3x80-4x100-5x125-6x150	4
4550 17 0135	<b>135mm Kontrol Kalem</b> Voltage Tester	1
2400 11 0240	<b>240mm Üniversal Fort Pense</b> Water Pump Pliers Universal	1
1113	<b>1/2" Lokma Anahtar</b> Socket Wrench 10-11-12-13-14-15-17-19-22-24-27-30-32 mm	13
1513 06 4250	<b>1/2" Uzun Ara Kol</b> Extension Bar Long 250 mm	1
1513 06 4070	<b>1/2" Mafsalsal</b> Universal Joint 70 mm	1
1512 06 0032	<b>1/2" Cırcır Kol 32 Dişli</b> Ratchet Handle 250 mm	1
4900 00 3112	<b>12 'Li Allen Takım</b> Hex Key Wrench Set	1
0320	<b>Kısa Kombine Anahtar</b> Combination Wrench Short Pattern 8-9-10-11-12-13-14-17-19-22 mm	10
3700 16 2160	<b>160mm Opak İzole Yan Keski</b> Side Cutting Nippers, Opak insulated	1
3020 12 2180	<b>180mm Opak İzole Kombine Pense</b> Combination Pliers, Opak Insulated	1
3220 13 2160	<b>160mm Opak İzole Düz Kargaburun</b> Nose Pliers, Flat, Opak Insulated	1

**8420 00 5046**
**Elektrikçi Takım Çantası (5 Gözlü)**  
*Tool Box for Electrician (5 Trays)*

KOD CODE	ÖLÇÜ SIZE mm	TL/Ad.
8420 00 5046	190x420x200 <b>DOLU / FULL</b>	45 1431,80

KOD CODE	İÇERİK CONTENTS	
05881 50 005	<b>5m Plastik Şerit Metre</b> Plastic Measuring Tape	1
4783 19 6120	<b>1000V İzoleli Manyetik Bits Tutucu Tornavida</b> Screwdriver, Magnetic Bit Holder Insulated 6.3x120	1
4800 00 8106	<b>6 'Li Bits Takım</b> Bits Set (6 Pcs)	1
0600 01 1010	<b>10" Kurbağcık Anahtar</b> Adjustable Jaw Wrench, PVC Insulated	1
4140-4145	<b>1000V İzoleli Elektrikçi Düz Yıldız Tornavida</b> Insulated Electrician type Flat Screwdriver, Phillips 1000V 4x100-5.5x125 - 4.5x80-6x100	4
4550 17 0135	<b>135mm Kontrol Kalem</b> Voltage Tester	1
4550 17 0190	<b>190mm Kontrol Kalem</b> Voltage Tester	1
4773	<b>1000V Süngüsü İzoleli Lokma Uçlu Tornavida</b> Nut Spinner, Electrician Blade Insulated 1000V 6-7-8-10-13 mm	5
0340	<b>Cırcır Kombine Anahtar</b> Combination Wrench With Ratchet 8-10-12-13-17-19 mm	6
4900 00 3110	<b>10 'Lu Allen Anahtar Takımı (mm)</b> Hex Key Wrench Set 10 pcs	1
4500-4520	<b>Klemens Tornavida</b> Screwdriver, Electronic 3x80-3x100-3x125-3x60-4x80	5
3700 16 6160	<b>1000V İzoleli Elektrikçi 160mm Yan Keski</b> Insulated Electrician Type Side Cutter 1000V	1
3020 12 6180	<b>1000V İzoleli Elektrikçi 180mm Kombine Pense</b> Insulated Electrician Type Combination Plier 1000V	1
3220 13 6160	<b>1000V İzoleli Elektrikçi 160mm Kargaburun</b> Insulated Electrician Type Nose Plier 1000V	1

**8420 00 5028**
**Tesisatçı Takım Çantası (5 Gözlü)**  
*Tool Box for Plumbers (5 Trays)*

KOD CODE	ÖLÇÜ SIZE mm	TL/Ad.
8420 00 5028	190x420x200 <b>DOLU / FULL</b>	28 1360,45

KOD CODE	İÇERİK CONTENTS	
0600 01 1010	<b>10" Kurbağcık Anahtar</b> 10" Adjustable Jaw Wrench, PVC Insulated	1
0600 01 1012	<b>12" Kurbağcık Anahtar</b> 12" Adjustable Jaw Wrench, PVC Insulated	1
2400 11 0240	<b>240 Üniversal Fort Pense</b> 240 Waterpump Pliers, Universal	1
2100 10 0012	<b>12" Stilson Boru Anahtarı</b> 12" Pipe Wrench, Stillson	1
4901 22 1270	<b>1/2" Sae Allen Anahtar</b> 1/2" Hex Key Wrench SAE	1
4300 17 6150	<b>Düz Uçlu Tornavida Opak Seri</b> Screwdriver, Opak, Slotted 6x150 mm	1
4320 18 6100	<b>Yıldız Uçlu Tornavida Opak Seri</b> Screwdriver, Opak, Phillips 6x100 mm	1
5800 25 0500	<b>500gr Çekiç / Machinist Hammer</b>	1
5500 23 0200	<b>200mm Beton Keski / Flat Cold Chisel</b>	1
3830 15 0250	<b>250mm Betoncu Kerpeten</b> Tower Pincers	1
4900 00 3112	<b>12 'Li Allen Anahtar Takımı (mm)</b> Hex Key Wrench Set 12 pcs	1
0588 15 0015	<b>5m Krom Şerit Metre</b> Chrom Case Steel Measuring Tape	1
2201 10 0010	<b>1" Maşalı Boru Anahtarı</b> 1" Pipe Wrench	1
3700 16 2160	<b>160mm Opak İzole Yan Keski</b> Side Cutting Nippers, Opak insulated	1
3020 12 2180	<b>180mm Opak İzole Kombine Pense</b> Combination Pliers, Opak Insulated	1
3220 13 2160	<b>160mm Opak İzole Düz Kargaburun</b> Nose Pliers, Flat, Opak Insulated	1

8440

1

Plastik Takım Çantaları  
Plastic Tool Boxes



KOD CODE	inch	ÖLÇÜ SIZE mm	g	□	TL/ Ad.
8440 33 1016	16"	413x212x186	1207	4	39,65
8440 33 1019	19"	480x267x242	1922	4	54,20
8440 33 1022	22"	564x310x310	2870	4	94,50



8705 00 6113

Hobby Set Oto Tipi (13 Parça)  
Hobby Set Auto Type (13 pcs)



KOD CODE	İÇERİK CONTENTS	□	TL/Ad.
0100	<b>İki Ağız Anahtar (Kısa Boy)</b> Duble Ended Open Jaw Wrench Short Pattern 8x9-10x11-12x13-14x15-16x17-18x19	6	335,20
1841	<b>21 mm Kovan Anahtar Bir Ağız</b> Single Ended Tubular Socket Wench	1	
2400	<b>240 mm Ünlversal Fort Pense</b> Waterpump Pliers Universal	1	
3020	<b>160 mm Kombine Pense Opak</b> Combination Pliers	1	
4240	<b>Değişken Uçlu Tornavida Takımı</b> Screwdriver Set Reversible 4.5x80 - 6x80	1	
5800	<b>200 gr Tesviyeci Çekiç / Machinist Hammer</b>	1	
6350	<b>300 mm Levye Oluklu / Tyre Lever Straight</b>	1	

8790 00 8106

Bakım Onarım Seti (5 Parça)  
Maintenance Set (5 Pcs)



KOD CODE	İÇERİK CONTENTS	□	TL/Ad.
3020 12 3160	<b>160 mm Kombine Pense Kraft</b> Combination Pliers	1	247,55
3220 13 3160	<b>160 mm Kargaburun Düz Uçlu Kraft</b> Nose Pliers Flat	1	
3700 16 3140	<b>140 mm Yan Keski Kraft</b> Side Cutting Pliers	1	
4100 17 5100	<b>5x100 Kraft Seri Düz Uçlu Tornavida</b> Screwdriver Kraft, Flat	1	
4120 18 4580	<b>4.5x80 Kraft Seri Yıldız Uçlu Tornavida</b> Screwdriver Kraft, Phillips	1	



Anahtar İşleme Aşamaları / Manufacturing steps





# 2

## Anahtarlar Wrenches



- |                              |                             |
|------------------------------|-----------------------------|
| <i>İki Ağız Anahtarlar</i>   | <i>Open Jaw Wrenches</i>    |
| <i>Kombine Anahtarlar</i>    | <i>Combination Wrenches</i> |
| <i>Yıldız Anahtarlar</i>     | <i>Ring Wrenches</i>        |
| <i>Çakma Anahtarlar</i>      | <i>Slugging Wrenches</i>    |
| <i>Kurbağacık Anahtarlar</i> | <i>Adjustable Wrenches</i>  |

★ Fiyat belirtilmeyen ebatlar için miktar belirterek fiyat talep ediniz.

İki Ağız Anahtar Kısa Boy (mm)  
Double Ended Open Jaw Wrench Short Pattern (mm)



TS 81-6  
DIN 895

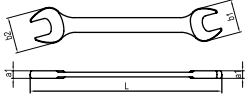

Krom vanadyum, Krom kaplı  
Chrom vanadium, Chrom plated

0100

İki Ağız Anahtar Takımı Kısa Boy (mm)  
Double Ended Open Jaw Wrench  
Short Pattern Set (mm)



KOD CODE	mm	L mm	a1 mm	b1 mm	b2 mm	g	TL/ Ad.
0100 01 0405	4x5	97	3.5	11	12.5	15	7,85
0100 01 0607	6x7	97	3.5	14	16	18	8,00
0100 01 0809	8x9	108	4	18	20	30	8,20
0100 01 0810	8x10	117	4.6	18	22	33	8,40
0100 01 1011	10x11	120	4.6	22	24	41	8,95
0100 01 1012	10x12	120	4.6	22	26	35	8,95
0100 01 1013	10x13	120	4.6	22	28	38	9,60
0100 01 1114	11x14	133	5.2	26	28	50	9,85
0100 01 1213	12x13	133	5.2	26	28	57	9,85
0100 01 1214	12x14	147	5.2	26	30	59	9,85
0100 01 1314	13x14	147	5.2	28	30	66	9,85
0100 01 1415	14x15	147	5.8	30	32	78	11,45
0100 01 1317	13x17	162	6.2	28	36	80	13,00
0100 01 1417	14x17	162	6.2	30	36	90	13,35
0100 01 1617	16x17	162	6.2	34	36	109	13,35
0100 01 1719	17x19	178	7	36	40	143	14,30
0100 01 1819	18x19	178	7	38	40	144	14,30
0100 01 1820	18x20	178	7	38	40	125	16,20
0100 01 1822	18x22	195	7.4	38	46	160	16,20
0100 01 1922	19x22	195	7.4	40	46	175	16,20
0100 01 2022	20x22	195	7.4	42	46	196	16,20
0100 01 2123	21x23	213	7.7	44	48	230	16,95
0100 01 2224	22x24	213	8	46	50	239	17,70
0100 01 2426	24x26	232	8.2	50	54	297	18,25
0100 01 2427	24x27	232	8.2	50	56	296	18,25
0100 01 2528	25x28	248	8.6	52	57.5	366	22,65
0100 01 2732	27x32	265	9	56	66	415	27,00
0100 01 3032	30x32	265	9	62	66	465	27,00

ÖZEL SERİLER (adet ve termin süresi isteyiniz)

0100 01 0608	6x8	97	3.5	14	18	20	10	8,00
0100 01 0708	7x8	108	3.5	16	18	20	10	8,20
0100 01 0709	7x9	108	4	16	20	25	10	8,20
0100 01 0910	9x10	117	4.6	20	22	30	10	8,40
0100 01 0911	9x11	120	4.6	20	24	30	10	8,95
0100 01 1014	10x14	120	5.2	22	30	50	10	9,60
0100 01 1113	11x13	133	5.2	26	28	50	10	9,85
0100 01 1315	13x15	147	5.8	28	32	65	10	11,45
0100 01 1722	17x22	195	7.4	36	46	160	10	16,20
0100 01 1924	19x24	213	7.7	40	50	200	10	16,95
0100 01 2226	22x26	232	8	46	54	250	10	18,25
0100 01 2227	22x27	232	8.2	46	56	260	10	18,25
0100 01 2430	24x30	265	9	50	62	370	10	27,00
0100 01 2730	27x30	265	9	56	62	380	10	27,00

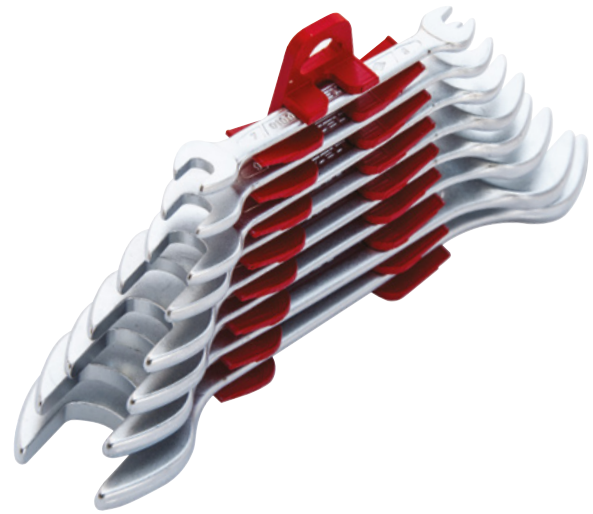

KOD CODE	İÇERİK CONTENTS	g	TL/ Ad.
0100 00 2108	6x7 - 8x9 - 10x11 12x13 - 14x15 - 16x17 18x19 - 20x22	736	8 90,30
0100 00 2112	6x7 - 8x9 - 10x11 12x13 - 14x15 - 16x17 18x19 - 20x22 - 21x23 24x26 - 25x28 - 30x32	2110	12 175,15

**0130**

**İki Ağız Anahtar Uzun Boy (mm)**

Double Ended Open Jaw Wrench Long Pattern (mm)

TS ISO 10102  
DIN 3110

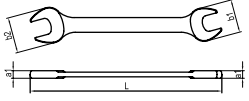

Krom vanadyum, Krom kaplı  
Chrom vanadium, Chrom plated

2

KOD CODE	mm	L mm	a1 mm	b1 mm	b2 mm	g		TL/Ad.
0130 01 0607	6x7	125	3.5	14	16	24	10	10,25
0130 01 0608	6x8	125	3.5	14	18	20	10	10,60
0130 01 0809	8x9	140	4	18	20	35	10	10,60
0130 01 0810	8x10	140	4	18	22	36	10	10,60
0130 01 1011	10x11	155	4.5	22	24	47	10	11,70
0130 01 1012	10x12	162	4.7	22	26	57	10	11,70
0130 01 1013	10x13	162	4.7	22	28	61	10	11,70
0130 01 1014	10x14	162	4.7	22	28	65	10	11,70
0130 01 1113	11x13	172	5	26	28	70	10	11,70
0130 01 1114	11x14	172	5	26	30	65	10	11,70
0130 01 1213	12x13	172	5	26	28	67	10	12,35
0130 01 1214	12x14	172	5	26	30	65	10	12,35
0130 01 1314	13x14	188	5.5	28	30	85	10	12,35
0130 01 1315	13x15	188	5.5	30	32	93	10	12,35
0130 01 1415	14x15	188	5.5	30	32	91	10	14,35
0130 01 1317	13x17	205	6.2	28	36	111	10	15,65
0130 01 1417	14x17	205	6.2	30	36	106	10	15,65
0130 01 1617	16x17	205	6.2	34	36	120	10	15,85
0130 01 1618	16x18	220	7	36	40	165	10	17,95
0130 01 1719	17x19	220	7	36	40	160	10	16,95
0130 01 1819	18x19	220	7	38	40	161	10	16,95
0130 01 1921	19x21	235	7.5	40	46	195	5	19,70
0130 01 1922	19x22	235	7.5	40	46	195	5	19,70
0130 01 2022	20x22	235	7.5	42	46	195	5	19,70
0130 01 1924	19x24	248	8.3	40	50	235	5	19,80
0130 01 2123	21x23	248	8.3	44	48	235	5	20,10
0130 01 2224	22x24	248	8.3	46	50	235	5	20,70
0130 01 2426	24x26	265	8.8	50	54	300	5	23,65
0130 01 2427	24x27	265	8.8	50	56	300	5	23,65
0130 01 2430	24x30	282	9.3	50	61.5	380	5	26,50
0130 01 2528	25x28	282	9.3	52	57.5	390	5	26,50
0130 01 2729	27x29	300	9.8	56	59	400	5	33,05
0130 01 2730	27x30	300	9.8	56	59	440	5	33,05
0130 01 2732	27x32	300	9.8	56	65.5	460	5	33,05
0130 01 3032	30x32	300	9.8	61.5	65.5	480	5	33,05
0130 01 3036	30x36	325	10.4	61.5	76	645	5	62,85
0130 01 3236	32x36	325	10.4	65.5	76	680	5	62,85
0130 01 3436	34x36	330	10.4	71	76	690	5	62,85
0130 01 3641	36x41	360	12	76	87	955	5	97,65
0130 01 4146	41x46	400	12.5	87	98	1300	5	150,55
0130 01 4650	46x50	450	13	98	107	1635	5	167,00

**ÖZEL SERİLER (adet ve termin süresi isteyiniz)**

0130 01 0555	5x5.5	97	3.5	14	16	15	10	8,00
0130 01 0708	7x8	135	3.5	16	18	20	10	10,60
0130 01 0709	7x9	140	4	16	20	30	10	10,60
0130 01 0910	9x10	140	4.5	20	22	45	10	11,70
0130 01 0911	9x11	155	4.5	20	24	45	10	11,70
0130 01 1722	17x22	235	7.5	36	46	190	5	19,70
0130 01 1724	17x24	248	8.3	36	50	240	5	19,80
0130 01 2227	22x27	265	8.8	46	56	300	5	23,65

**0130**

**İki Ağız Anahtar Takımı Uzun Boy (mm)**

Double Ended Open Jaw Wrench  
Long Pattern Set (mm)

TS ISO 10102  
DIN 3110



KOD CODE	İÇERİK CONTENTS	g		TL/Ad.
0130 00 2108	6x7 - 8x9 - 10x11 - 12x13 14x15 - 16x17 - 18x19 20x22	815	8	111,75
0130 00 2112	6x7 - 8x9 - 10x11 12x13 - 14x15 - 16x17 18x19 - 20x22 - 21x23 24x26 - 25x28 - 27x32	2315	12	215,05

İki Ağız Anahtar Uzun Boy (SAE)  
Double Ended Open Jaw Wrench Long Pattern (SAE)

TSEK

2



Krom vanadyum, Krom kaplı  
Chrom vanadium, Chrom plated

0161

İki Ağız Anahtar Takımı Uzun Boy (SAE)  
Double Ended Open Jaw Wrench  
Long Pattern Set (SAE)

TSEK

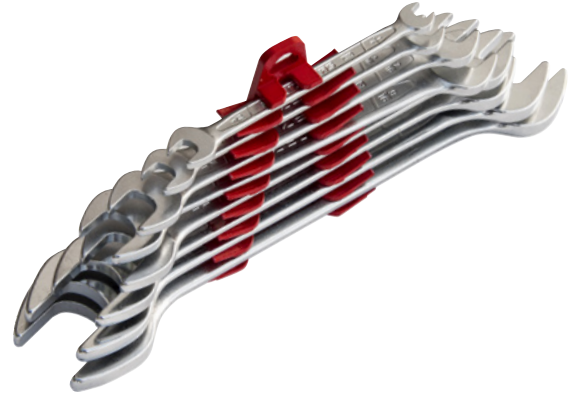
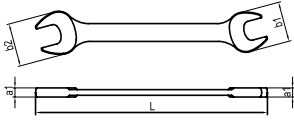

KOD CODE	inch	L mm	a1 mm	b1 mm	b2 mm	g	TL/ Ad.	
0161 01 0608	1/4"x5/16"	125	3.5	14	16	20	10	12,70
0161 01 0809	5/16"x3/8"	140	4	18	20	30	10	12,70
0161 01 0810	5/16"x11/32"	140	4	18	20	30	10	12,70
0161 01 0811	5/16"x7/16"	140	4	18	22	30	10	12,70
0161 01 0911	3/8"x7/16"	155	4.5	22	24	35	10	14,10
0161 01 1112	7/16"x1/2"	172	5	26	28	40	10	14,10
0161 01 1214	1/2"x9/16"	172	5	26	30	65	10	14,85
0161 01 1416	9/16"x5/8"	188	5.5	30	32	85	10	17,30
0161 01 1417	9/16"x11/16"	205	6.2	30	36	110	10	18,80
0161 01 1517	19/32"x11/16"	205	6.2	34	36	115	10	19,05
0161 01 1619	5/8"x3/4"	220	7	36	40	150	10	20,35
0161 01 1920	3/4"x25/32"	220	7	38	40	160	10	20,35
0161 01 2021	25/32"x13/16"	235	7.5	40	46	195	10	23,65
0161 01 1922	3/4"x7/8"	235	7.5	40	46	195	10	23,65
0161 01 2122	13/16"x7/8"	248	8.3	44	48	235	10	24,10
0161 01 2325	15/16"x1"	265	8.8	50	54	300	10	28,45
0161 01 2328	15/16"x1 1/8"	265	8.8	50	56	300	10	28,75
0161 01 2628	1 1/16"x1 1/8"	300	9.8	56	59.5	460	10	41,35
0161 01 2631	1 1/16"x1 1/4"	300	9.8	56	65.5	460	10	43,70
0161 01 2833	1 1/8"x1 5/16"	300	9.8	56	65.5	460	10	43,70

KOD CODE	İÇERİK CONTENTS	g	TL/ Ad.	
0161 00 2108	1/4"x5/16" - 5/16"x3/8" 7/16"x1/2" - 9/16"x5/8" - 19/32"x11/16" 3/4"x25/32" - 13/16"x7/8" - 15/16"x1"	1090	8	148,75
0161 00 2112	1/4"x5/16" - 5/16"x3/8" - 3/8"x7/16" 7/16"x1/2" - 1/2"x9/16" - 9/16"x5/8" 19/32"x11/16" - 3/4"x25/32" - 13/16"x7/8" 15/16"x1" - 1 1/16"x1 1/4" 1 1/8"x1 5/16"	2165	12	265,05

## 0250

### Bir Ağız Tağlı Anahtar (mm) Single Ended Open Jaw Wrench (mm)



Krom vanadyum  
Chrom vanadium

KOD CODE	mm	L mm	a1 mm	b1 mm	g	TL/Ad.
0250 01 0030	30	260	10.5	60.2	250	5 47,40
0250 01 0036	36	300	10.5	74.6	370	5 59,80
0250 01 0041	41	345	12.2	85.5	550	5 78,15
0250 01 0046	46	390	14	96.3	750	5 84,10
0250 01 0050	50	425	15.2	105	1000	5 105,00
0250 01 0055	55	455	16.5	113.5	1300	1 140,80
0250 01 0060	60	490	18.4	121	1600	1 180,30
0250 01 0065	65	524	19	130	1980	1 219,80

### ÖZEL SERİLER (adet ve termin süresi isteyiniz)

0250 01 0021	21	185	8	42.4	95	10	-----
0250 01 0022	22	195	8	44.4	110	10	-----
0250 01 0023	23	195	8	46.3	115	10	-----
0250 01 0024	24	215	9	48.3	150	10	-----
0250 01 0025	25	215	9	50.3	155	10	-----
0250 01 0027	27	240	9.5	54.3	200	5	-----
0250 01 0032	32	270	10.5	64	300	5	-----
0250 01 0034	34	270	10.5	68	320	5	-----
0250 01 0038	38	300	10.5	76.8	400	5	-----
0250 01 0070	70	564	20.8	140	2480	1	-----
0250 01 0075	75	608	21.8	151	3100	1	-----

## 0255

### Süper İzole Çatal Bir Ağız Anahtar (mm) Single Ended Open Jaw Wrench Super Insulated (mm)



Krom vanadyum, Krom kaplı, Kalın PVC izoleli  
Chrom vanadium, Chrom plated, Triple PVC insulated

KOD CODE	mm	L mm	g	TL/Ad.
0255 01 0010	10	110	40	10 27,65
0255 01 0011	11	120	45	10 29,20
0255 01 0012	12	130	50	10 30,50
0255 01 0013	13	140	60	10 32,90
0255 01 0014	14	155	75	10 34,15
0255 01 0017	17	170	100	10 41,90
0255 01 0019	19	185	150	10 49,20
0255 01 0022	22	200	200	10 66,20
0255 01 0024	24	220	280	10 81,00

## 0325

### Montaj Anahtar (mm) Speed Wrench (mm)



Krom vanadyum, Krom kaplı  
Chrom vanadium, Chrom plated

KOD CODE	mm	L mm	a1 mm	a2 mm	b1 mm	σD mm	g	TL/Ad.
0325 02 0010	10	130	4.3	6.9	22	15.5	35	10 17,70
0325 02 0013	13	160	5.2	7.9	28	19.5	45	10 19,80
0325 02 0017	17	200	6.4	9.8	36	25.5	110	10 26,25
0325 02 0019	19	220	7	11	40	28.5	155	10 30,75
0325 02 0020	20	235	7.2	11.4	42	30	180	10 31,30
0325 02 0021	21	245	7.4	12	44	31.5	180	10 36,45
0325 02 0022	22	255	8.2	12.6	46	33	245	10 41,70

### %100 Daha Hızlı

Yeni tasarlanan montaj anahtarı, 2 kat hızlı cırcır mekanizması mantığına dayanan çalışma prensibinden alır. Kullanım sırasında, montaj anahtarını civatadan ayırmadan döndürme kolaylığı kullanım hızını artırırken, civata köşelerine sağlam tutunan anahtar profili güvenli ve kaydırmaz kullanım sağlar.

### Uzun Ömür

Bu yeni montaj anahtar profili, civata ve somunlar ile köşelerinden değil düz yüzeyleri üzerinden temas ederek düzenli tork iletimini sağlarken, gerilimin artmasını da engelleyen anahtar ömrünün uzamasını sağlar.

- Anahtarı civatadan ayırmadan hızlı kullanım.
- Güvenli tork iletimi ve uzun ömür.

**Kombine Anahtar Kısa Boy (mm)**  
*Combination Wrench Short Pattern (mm)*



TS 3794  
TS ISO 7738 Form A  
DIN 3113

2

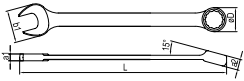

Krom vanadyum, Krom kaplı  
*Chrom vanadium, Chrom plated*

KOD CODE	mm	L mm	a1 mm	a2 mm	b1 mm	øD mm	g	TL/Ad.
0320 02 0005	5	100	3.4	5.1	14	10	15	10,25
0320 02 0055	5.5	100	3.4	5.1	14	10	15	10,25
0320 02 0006	6	100	3.4	5.1	14	10	15	10,60
0320 02 0007	7	110	3.6	5.5	16	11	20	11,25
0320 02 0008	8	120	3.8	5.9	18	13	25	12,25
0320 02 0009	9	130	4	6.3	20	14	30	12,55
0320 02 0010	10	140	4.3	6.9	22	15.5	40	14,20
0320 02 0011	11	150	4.5	7.3	24	17	45	14,55
0320 02 0012	12	160	4.9	7.7	26	18.5	55	15,55
0320 02 0013	13	170	5.2	7.9	28	19.5	60	15,85
0320 02 0014	14	180	5.5	8.7	30	21.5	75	17,15
0320 02 0015	15	190	5.8	9.1	32	22.5	90	18,35
0320 02 0016	16	200	6.1	9.6	34	24	105	19,70
0320 02 0017	17	210	6.4	9.8	36	25.5	120	21,00
0320 02 0018	18	220	6.8	10.4	38	27	145	23,50
0320 02 0019	19	232	7	11	40	28.5	170	24,70
0320 02 0020	20	240	7.2	11.4	42	30	195	25,15
0320 02 0021	21	250	7.4	12	44	31.5	190	29,20
0320 02 0022	22	260	8.2	12.6	46	33	275	33,40
0320 02 0023	23	270	8.3	13	48	35	255	33,40
0320 02 0024	24	280	8.5	13.6	50	36.5	320	40,85
0320 02 0025	25	290	8.8	14	52	39	320	40,85
0320 02 0026	26	300	9	14.8	54	41	400	48,15
0320 02 0027	27	310	9.3	15	56	41.5	400	48,15
0320 02 0028	28	320	9.4	15.4	57.5	42.5	380	48,15
0320 02 0029	29	330	10	15.6	59	43.5	510	55,15
0320 02 0030	30	340	10.3	16	61.5	44	505	55,15
0320 02 0032	32	370	10.5	16.2	65.5	47	560	58,00
0320 02 0034	34	400	10.7	16.8	71	50	675	60,65

0320

**Kombine Anahtar Takımı Kısa Boy (mm)**  
*Combination Wrench Short Pattern Set (mm)*



KOD CODE	İÇERİK CONTENTS	g	TL/Ad.
0320 00 2108	6 - 7 - 8 - 9 - 10 - 13 - 17 - 19	475	8 122,40
0320 00 2112	8 - 9 - 10 - 11 - 12 - 13 - 14 15 - 16 - 17 - 19 - 22	1190	12 219,25
0320 00 2117	6 - 7 - 8 - 9 - 10 - 11 - 12 - 13 - 14 15 - 16 - 17 - 18 - 19 - 20 - 21 - 22	1760	17 318,95
0320 00 2121	6 - 7 - 8 - 9 - 10 - 11 - 12 - 13 - 14 15 - 16 - 17 - 18 - 19 - 20 - 21 - 22 24 - 27 - 30 - 32	3650	21 521,10

**Kombine Anahtar Uzun Boy (mm)**  
Combination Wrench, Long Pattern (mm)



TS 3794  
TS ISO 7738 Form A  
DIN 3113

2

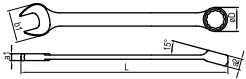
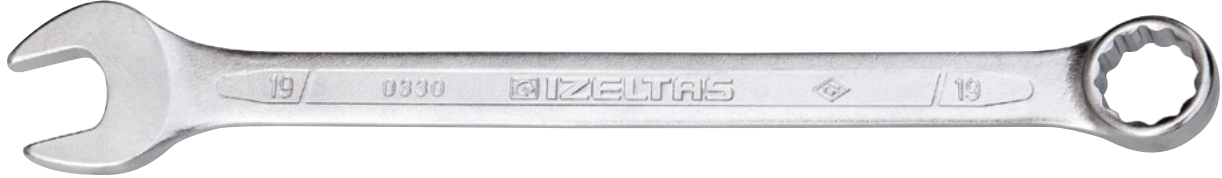

**Krom vanadyum, Krom kaplı**  
Chrom vanadium, Chrom plated

KOD CODE	mm	L mm	a1 mm	a2 mm	b1 mm	øD mm	g	TL/Ad.	
0330 02 0005	5	95	3.2	5.2	12.5	9	20	10	11,80
0330 02 0055	5.5	100	3.4	5.4	13.5	9.5	20	10	11,80
0330 02 0006	6	105	3.8	5.6	14	10.5	20	10	11,80
0330 02 0007	7	117	4	6.1	16	12	20	10	11,80
0330 02 0008	8	130	4.2	6.6	18	13.5	30	10	13,80
0330 02 0009	9	141	4.5	7	20	15	40	10	14,00
0330 02 0010	10	154	4.7	7.6	22	16	50	10	15,55
0330 02 0011	11	166	5	8.2	24	17.5	60	10	16,40
0330 02 0012	12	178	5.2	8.7	26	19	70	10	16,40
0330 02 0013	13	190	5.6	9.2	28	20.5	80	10	18,40
0330 02 0014	14	203	5.8	9.7	30	22	100	10	19,15
0330 02 0015	15	215	6.4	10.1	32	23.5	115	10	20,45
0330 02 0016	16	227	6.4	10.8	34	25	135	10	20,70
0330 02 0017	17	239	6.6	11.4	36	26.5	160	10	23,50
0330 02 0018	18	250	7	12	38	28	186	10	25,40
0330 02 0019	19	263	7.3	12.7	40	29.5	205	10	27,55
0330 02 0020	20	275	7.7	13.2	42	31	235	10	29,30
0330 02 0021	21	288	8.1	13.3	44	31.5	260	10	31,20
0330 02 0022	22	300	8.5	13.7	46	34	300	10	37,10
0330 02 0023	23	315	8.8	14.2	48	35.5	300	5	45,40
0330 02 0024	24	330	9	14.2	50	37	390	5	45,40
0330 02 0025	25	340	9.3	14.7	52	38.5	380	5	45,40
0330 02 0026	26	350	9.7	14.7	54	40	475	5	53,45
0330 02 0027	27	360	10	15.2	56	41	475	5	53,45
0330 02 0028	28	370	10.4	15.7	57.5	43	475	5	53,45
0330 02 0029	29	390	10.8	16.2	59	44	610	5	53,45
0330 02 0030	30	410	11.2	16.6	61.5	45	610	5	61,40
0330 02 0032	32	420	11.5	17.1	65.5	48	755	5	64,35
0330 02 0034	34	430	11.8	17.4	71	51	735	5	65,60
0330 02 0036	36	440	12.2	17.7	76	53	1000	5	74,35
0330 02 0038	38	450	12.5	18.7	80	56	1000	5	76,10
0330 02 0041	41	480	13.5	19.7	87	61	1240	5	86,60
0330 02 0046	46	505	14.7	20.7	95	67.5	1635	1	117,70
0330 02 0050	50	540	15.9	22.7	104	73.5	2100	1	159,65

0330

**Kombine Anahtar Takımı Uzun Boy (mm)**  
Combination Wrench Long Pattern Set (mm)



KOD CODE	İÇERİK CONTENTS	g	TL/Ad.	
0330 00 2108	6 - 7 - 8 - 9 - 10 - 13 17 - 19	665	8	136,40
0330 00 2112	8 - 9 - 10 - 11 - 12 13 - 14 - 15 - 16 17 - 19 - 22	1780	12	243,00
0330 00 2117	6 - 7 - 8 - 9 - 10 11 - 12 - 13 - 14 - 15 16 - 17 - 18 - 19 20 - 21 - 22	2170	17	352,50
0330 00 2121	6 - 7 - 8 - 9 - 10 - 11 12 - 13 - 14 - 15 - 16 17 - 18 - 19 - 20 - 21 22 - 24 - 27 - 30 - 32	4465	21	577,10

Kombine Anahtar Uzun Boy (SAE)  
Combination Wrench Long Pattern (SAE)

TSEK

2



Krom vanadyum, Krom kaplı  
Chrom vanadium, Chrom plated

0331

Kombine Anahtar Takımı Uzun Boy (SAE)  
Combination Wrench Long Pattern Set (SAE)

TSEK

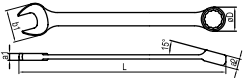

KOD CODE	inch	L mm	a1 mm	a2 mm	b1 mm	øD mm	g	TL/Ad.
0331 02 0005	3/16"	95	3.2	5.2	12.5	9	15	10 14,20
0331 02 0006	1/4"	105	3.8	5.6	14	10.5	20	10 14,75
0331 02 0008	5/16"	130	4.2	6.6	18	13.5	30	10 17,20
0331 02 0010	3/8"	154	4.7	7.6	22	16	50	10 19,60
0331 02 0011	7/16"	166	5	8.2	24	17.5	60	10 20,60
0331 02 0013	1/2"	190	5.6	9.2	28	20.5	80	10 23,25
0331 02 0014	9/16"	203	5.8	9.7	30	22	100	10 24,50
0331 02 0015	19/32"	215	6.4	10.1	32	23.5	115	10 25,90
0331 02 0016	5/8"	227	6.4	10.8	34	25	135	10 27,85
0331 02 0017	11/16"	239	6.6	11.4	36	26.5	155	10 29,65
0331 02 0019	3/4"	263	7.3	12.7	40	29.5	205	10 34,60
0331 02 0020	25/32"	275	7.7	13.2	42	31	230	10 37,05
0331 02 0021	13/16"	288	8.1	13.3	44	31.5	260	5 40,90
0331 02 0022	7/8"	300	8.5	13.7	46	34	310	5 47,10
0331 02 0024	15/16"	330	9	14.2	50	37	380	5 57,65
0331 02 0025	1"	340	9.3	14.7	52	38.5	380	5 57,65
0331 02 0027	1 1/16"	360	10	15.2	56	41	470	5 67,50
0331 02 0028	1 1/8"	370	10.4	15.7	57.5	43	470	5 67,50
0331 02 0030	1 3/16"	410	11.2	16.6	61.5	45	635	5 77,35
0331 02 0032	1 1/4"	420	11.5	17.1	65.5	48	775	5 81,10
0331 02 0033	1 5/16"	430	11.8	17.4	71	51	775	5 81,10
0331 02 0038	1 1/2"	450	12.5	18.7	80	56	1015	5 98,00

**ÖZEL SERİLER (adet ve termin süresi isteyiniz)**

0331 02 0035	1 3/8"	440	12.2	17.7	76	53	1015	5 89,15
0331 02 0036	1 7/16"	440	12.2	17.7	76	53	1015	5 89,15
0331 02 0041	1 5/8"	480	13.5	19.7	87	61	1325	5 103,90
0331 02 0046	1 13/16"	505	14.7	20.7	95	67.5	1750	5 141,25
0331 02 0050	2"	540	15.9	22.7	104	73.5	2200	5 191,55

KOD CODE	İÇERİK CONTENTS	g	TL/Ad.
0331 00 2108	5/16" - 3/8" - 7/16" - 1/2" - 9/16" 5/8" - 11/16" - 3/4"	925	8 197,25
0331 00 2112	5/16" - 3/8" - 7/16" - 1/2" - 9/16" 5/8" - 11/16" - 3/4" - 13/16" - 7/8" 15/16" - 1"	2320	12 400,55
0331 00 2117	1/4" - 5/16" - 3/8" - 7/16" - 1/2" 9/16" - 19/32" 5/8" - 11/16" - 3/4" - 25/32" - 13/16" 7/8" - 15/16" - 1" 1 1/16" - 1 3/16"	3875	17 623,10
0331 00 2120	1/4" - 5/16" - 3/8" - 7/16" 1/2" - 9/16" - 19/32" - 5/8" - 11/16" 3/4" - 25/32" 13/16" - 7/8" - 15/16" 1" - 1 1/16" - 1 1/8" 1 3/16" - 1 1/4" - 1 5/16"	5880	20 852,80



## 0340

### Cırcır Kombine Anahtar (mm) Combination Wrench With Ratchet (mm)

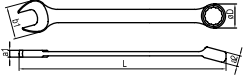

KOD CODE	mm	L mm	a1 mm	a2 mm	b1 mm	øD mm	g		TL/Ad.
0340 02 0008	8	136	5.1	7	18	17.5	35	10	45,35
0340 02 0009	9	143	5.4	7.6	20	19.3	40	10	45,35
0340 02 0010	10	160	5.8	7.7	22	21	55	10	46,80
0340 02 0011	11	168	6.1	8.3	24.5	22.7	70	10	47,10
0340 02 0012	12	174	6.4	8.7	26.5	24.7	80	10	51,00
0340 02 0013	13	180	6.7	9.3	27.6	26	90	10	54,70
0340 02 0014	14	193	7.4	9.4	31.4	27.7	120	10	56,35
0340 02 0015	15	200	7.7	10	33.4	29	135	10	59,70
0340 02 0016	16	216	8.1	10.6	34.6	30.7	155	10	68,40
0340 02 0017	17	233	8.8	10.9	38.4	33	190	10	72,45
0340 02 0018	18	239	9	11.2	39.9	33.7	200	10	78,50
0340 02 0019	19	250	9.5	11.5	41.5	34.8	240	10	83,45
0340 02 0021	21	285	10.2	13	45.8	42	350	10	116,10
0340 02 0022	22	285	10.2	13	45.8	42	340	10	127,40
0340 02 0024	24	325	11	14.5	51.5	47.5	470	5	143,95

## 0335

### Çoklu Yıldız Cırcır Anahtar (mm) Multi-Ring Wrench (mm)



Krom vanadyum, Krom kaplı  
Chrom vanadium, Chrom plated

KOD CODE	ÖLÇÜ SIZE	g		TL/Ad.
0335 02 0010	10x13x17x19	215	5	158,65

## 0340

### Cırcır Kombine Anahtar Takımı (mm) Combination Wrench With Ratchet, Set (mm)



KOD CODE	İÇERİK CONTENTS	g		TL/Ad.
0340 00 2110	8 - 9 - 10 - 11 12 - 13 - 14 - 15 17 - 19	1315	10	562,25
0340 00 2115	8 - 9 - 10 - 11 - 12 - 13 14 - 15 - 16 - 17 - 18 19 - 21 - 22 - 24	2445	15	1096,60

**Mafsallı Cırcır Kombine Anahtar (mm)**  
*Flexible Head Combination Wrench With Ratchet (mm)*

2



Krom vanadyum, Krom kaplı  
*Chrom vanadium, Chrom plated*

**0345**

**Mafsallı Cırcır Kombine Anahtar Takımı (mm)**  
*Flexible Head Combination Wrench With Ratchet, Set (mm)*

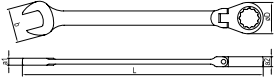

KOD CODE	mm	L mm	a1 mm	a2 mm	b mm	ØD mm	g	TL/Ad.
0345 02 0008	8	136	5.5	7	17.1	17.5	40	10
0345 02 0009	9	136	5.5	7	17.1	17.5	50	10
0345 02 0010	10	140	6.1	7.7	21.3	21	60	10
0345 02 0011	11	142	6.4	8.3	23.7	22.7	80	10
0345 02 0012	12	143	6.7	8.7	25.8	24	90	10
0345 02 0013	13	156	7	9.3	26.8	26	105	10
0345 02 0014	14	164	7.3	9.4	30.4	27.7	125	10
0345 02 0015	15	174	7.7	10	31.1	29.1	145	10
0345 02 0016	16	176	8	10.6	33.8	30.7	185	10
0345 02 0017	17	195	8.3	10.9	37	32.6	210	10
0345 02 0018	18	213	8.6	11.2	38.7	33.7	235	10
0345 02 0019	19	214	9	11.3	40.2	34.8	260	10

KOD CODE	İÇERİK CONTENTS	g	TL/Ad.
0345 00 2112	8 - 9 - 10 - 11 - 12 - 13 14 - 15 - 16 - 17 - 18 - 19	1365	12
			1000,30



0370

Boyunlu Kombine Anahtar (mm)  
Offset Combination Wrench (mm)



TS 3794  
TS ISO 7738 Form B  
DIN 3113

2



Krom vanadyum, Krom kaplı  
Chrom vanadium, Chrom plated

0370

Boyunlu Kombine Anahtar Takımı (mm)  
Offset Combination Wrench, Set (mm)

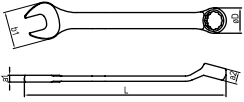

KOD CODE	mm	L mm	a1 mm	a2 mm	b1 mm	σD mm	g	TL/Ad.
0370 02 0006	6	110	3.8	5.6	16	10.4	20	10, 12,15
0370 02 0007	7	120	4	6.2	18	11.8	25	10, 12,95
0370 02 0008	8	130	4.2	6.7	20	13.2	30	10, 14,10
0370 02 0009	9	140	4.4	7.3	22	14.6	35	10, 14,45
0370 02 0010	10	150	4.6	7.8	24	16	40	10, 16,30
0370 02 0011	11	160	4.8	8.4	26	17.2	50	10, 16,80
0370 02 0012	12	167	5	9	28	18.7	65	10, 18,00
0370 02 0013	13	175	5.4	9.6	30	20	75	10, 18,50
0370 02 0014	14	185	5.8	10.2	32	21.7	90	10, 19,80
0370 02 0015	15	195	6.2	10.8	34	23	105	10, 21,10
0370 02 0016	16	210	6.6	11.4	36	24.5	120	10, 22,70
0370 02 0017	17	225	7	12	38	26	160	10, 24,20
0370 02 0018	18	237	7.4	12.4	40	27.5	170	10, 27,05
0370 02 0019	19	250	7.8	13	42	29	200	10, 28,45
0370 02 0020	20	267	8.2	13.2	44	30.5	230	10, 29,90
0370 02 0021	21	283	8.6	13.8	46	32	265	10, 33,60
0370 02 0022	22	295	9	14.6	48	35	300	10, 38,50
0370 02 0023	23	295	9	14.6	48	35	300	5, 47,05
0370 02 0024	24	329	9.4	15.4	52	38	380	5, 47,05
0370 02 0025	25	329	9.4	15.4	52	38	380	5, 47,05
0370 02 0026	26	360	10.2	16.8	58	41.5	485	5, 55,40
0370 02 0027	27	360	10.2	16.8	58	41.5	475	5, 55,40
0370 02 0028	28	360	10.2	16.8	58	41.5	470	5, 55,40
0370 02 0029	29	394	11	18.2	64	44.5	610	5, 61,70
0370 02 0030	30	394	11	18.2	64	44.5	620	5, 63,65
0370 02 0032	32	435	11.8	19.7	66	47.5	765	5, 66,75
0370 02 0036	36	468	12.6	21.2	76	53	1020	5, 77,15

KOD CODE	İÇERİK CONTENTS	g	TL/Ad.
0370 00 2108	6 - 7 - 8 - 9 - 10 - 13 - 17 - 19	665	8 141,10
0370 00 2112	8 - 9 - 10 - 11 - 12 - 13 - 14 15 - 16 - 17 - 19 - 22	1375	12 252,90
0370 00 2117	6 - 7 - 8 - 9 - 10 - 11 - 12 - 13 - 14 15 - 16 - 17 - 18 - 19 - 20 - 21 - 22	2100	17 368,55
0370 00 2121	6 - 7 - 8 - 9 - 10 - 11 - 12 - 13 - 14 - 15 16 - 17 - 18 - 19 - 20 - 21 - 22 - 24 - 27 30 - 32	4425	21 601,40

Torx® - mm Kombine Anahtar  
Torx® - mm Combination Wrench

2

R&D  
AR-GE

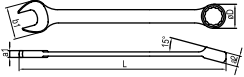

Krom vanadyum, Krom kaplı  
Chrom vanadium, Chrom plated

KOD CODE	mm	*	L mm	a1 mm	a2 mm	b1 mm	øD mm	g		TL/ Ad.
0380 02 0008	8	E10	170	4.5	7.5	20.3	13.2	45	10	23,55
0380 02 0009	9	E12	180	4.5	8	22.4	14.6	45	10	23,90
0380 02 0010	10	E14	190	5	8.5	24.4	16	60	10	26,55
0380 02 0011	11	E14	200	5.5	9	26.4	17.2	75	10	27,95
0380 02 0012	12	E16	210	6	9.5	28.4	19	90	10	28,75
0380 02 0013	13	E18	225	6.5	10	30.5	20	110	10	31,55
0380 02 0014	14	E18	235	7	11	32.5	21.8	120	10	34,90
0380 02 0015	15	E20	250	7.5	12	34.5	23	150	10	36,95
0380 02 0017	17	E22	280	8.5	14	38.4	26.5	210	10	40,15
0380 02 0018	18	E24	295	9	15	40.6	28	240	10	43,55
0380 02 0019	19	E24	310	9.5	16	42.6	29.5	280	10	47,15
0380 02 0022	22	E26	350	11	18	48.7	34.5	410	10	63,45

0380

Torx® - mm Kombine Anahtar Takımı  
Torx® - mm Combination Wrench Set



**Torx® -mm Kombine Anahtar:** Bir çatal ağız ve bir yıldız ağızdan oluşan anahtarlarımız 8-22 mm arasında boyları bulunmaktadır. Çatal ağız kısmı mevcut çatal anahtarlardan farklı olarak 6 köşe civatanın yanısıra farklı geometri lere sahip civataları açabilmekte ve sıkabilmektedir.

KOD CODE	İÇERİK CONTENTS	g		TL/ Ad.
	8 - 9 - 10 - 11 - 12 - 13 - 17 - 19			
0380 00 2108	E10 - E12 - E14 - E14 E16 - E18 - E22 - E24	790	8	249,55
	8 - 9 - 10 - 11 - 12 - 13 14 - 15 - 7 - 18 - 19 - 22			
0380 00 2112	E10 - E12 - E14 - E14 - E16 - E18 E18 - E20 - E22 - E24 - E24 - E26	1590	12	428,40

0430

Yıldız İki Ağız Anahtar (mm)  
Double Ended Ring Wrench (mm)



TS 3794  
TS ISO 10104 Form B  
DIN 838

2



Krom vanadyum, Krom kaplı  
Chrom vanadium, Chrom plated

KOD CODE	mm	L mm	a1 mm	a2 mm	b1 mm	b2 mm	g	TL/Ad.
0430 03 0607	6x7	176	5.6	6	10	11.5	55	10 18,40
0430 03 0809	8x9	190	6.4	6.8	13	14.5	75	10 18,70
0430 03 0810	8x10	190	6.4	7.3	13	15.5	70	10 18,70
0430 03 1011	10x11	206	7.3	7.6	15.5	17	105	10 20,70
0430 03 1012	10x12	206	7.3	8.5	15.5	18.5	105	10 20,70
0430 03 1013	10x13	220	7.3	9	15.5	20	120	10 23,50
0430 03 1113	11x13	220	7.6	9	17	20	130	10 23,50
0430 03 1213	12x13	220	8.5	9	18.5	20	135	10 23,50
0430 03 1214	12x14	220	8.5	9.5	18.5	21.5	145	10 23,50
0430 03 1415	14x15	236	9.5	10	21.5	23	180	10 24,70
0430 03 1317	13x17	250	9	11.5	20	26.5	215	10 28,00
0430 03 1417	14x17	250	9.5	11.5	21.5	26.5	210	10 28,00
0430 03 1617	16x17	250	10.8	11.5	25	26.5	220	10 28,00
0430 03 1618	16x18	250	10.8	12	25	27.5	210	10 33,30
0430 03 1719	17x19	271	11.5	12.5	26.5	29	270	10 33,30
0430 03 1819	18x19	271	12	12.5	27.5	29	270	10 33,30
0430 03 1922	19x22	291	12.5	13.5	29	33	330	5 36,55
0430 03 1924	19x24	311	12.5	14.2	29	36.5	345	5 36,55
0430 03 2022	20x22	291	12.9	13.5	30.5	33	330	5 36,55
0430 03 2123	21x23	311	13.1	14	32	35	410	5 41,90
0430 03 2224	22x24	321	13.5	14.2	33	36.5	410	5 41,90
0430 03 2426	24x26	331	14.2	14.6	36.5	39.5	495	5 48,80
0430 03 2427	24x27	331	14.2	15	36.5	40.5	495	5 48,80
0430 03 2430	24x30	352	14.2	16.7	36.5	40	530	5 53,45
0430 03 2528	25x28	352	14.5	15.5	38	42.5	550	5 53,45
0430 03 2729	27x29	371	15	16.7	40.5	45	660	5 58,80
0430 03 2730	27x30	371	15	16.7	40.5	45	660	5 58,80
0430 03 2732	27x32	371	15	16.7	40.5	47.5	660	5 58,80
0430 03 3032	30x32	371	16.4	16.7	45	47.5	660	5 58,80
0430 03 3036	30x36	402	16.4	17.5	45	53	880	5 90,75
0430 03 3236	32x36	402	16.7	17.5	47.5	53	890	5 90,75
0430 03 3436	34x36	420	17.1	17.5	50	53	1000	5 110,90
0430 03 3641	36x41	438	17.5	19.5	53	61	1150	5 123,30
0430 03 4146	41x46	485	19.5	20.5	61	67.5	1430	5 168,95
0430 03 4650	46x50	535	20.5	22.4	67.5	73.5	1960	5 268,85

ÖZEL SERİLER (adet ve termin süresi isteyiniz)

0430 03 1014	10x14	220	7.3	9.5	15.5	21.5	120	10 23,50
0430 03 1315	13x15	236	9	10	20	23	170	10 24,70
0430 03 2227	22x27	331	14.2	15	36.5	40.5	500	5 48,80
0430 03 3034	30x34	379	16.4	16.9	45	50	690	5 78,20

0430

Yıldız İki Ağız Anahtar Takımı (mm)  
Double Ended Ring Wrench Set (mm)



KOD CODE	İÇERİK CONTENTS	g	TL/Ad.
0430 00 2108	6x7 - 8x9 - 10x11 - 12x13 - 14x15 16x17 - 18x19 - 20x22	1450	8 203,85
0430 00 2112	6x7 - 8x9 - 10x11 - 12x13 - 14x15 16x17 - 18x19 - 20x22 - 21x23 24x26 - 25x28 - 27x32	3610	12 406,80

Yıldız İki Ağız Anahtar (SAE)  
Double Ended Ring Wrench (SAE)

TSEK

2

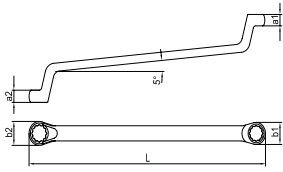

Krom vanadyum, Krom kaplı  
Chrom vanadium, Chrom plated

0431

Yıldız İki Ağız Anahtar Takımı (SAE)  
Double Ended Ring Wrench, Set (SAE)

TSEK

KOD CODE	inch	L mm	a1 mm	a2 mm	b1 mm	b2 mm	g	TL/Ad.
0431 03 0608	1/4"x5/16"	176	5.6	6	10	11.5	55	10 22,75
0431 03 0809	5/16"x3/8"	190	6.4	6.8	13	14.5	75	10 23,65
0431 03 0811	5/16"x7/16"	190	6.4	7.3	13	15.5	115	10 24,80
0431 03 0911	3/8"x7/16"	206	7.3	7.6	15.5	17	115	10 26,05
0431 03 1112	7/16"x1/2"	220	8.5	9	18.5	20	135	10 28,15
0431 03 1214	1/2"x9/16"	220	8.5	9.5	18.5	21.5	145	10 29,65
0431 03 1415	9/16"x19/32"	236	9.5	10	21.5	23	165	10 29,65
0431 03 1416	9/16"x5/8"	236	9.5	10	21.5	23	165	10 29,65
0431 03 1517	19/32"x11/16"	250	10.8	11.5	25	26.5	210	10 33,60
0431 03 1920	3/4"x25/32"	271	12	12.5	27.5	29	270	10 41,70
0431 03 2122	13/16"x7/8"	311	13.1	14	32	35	400	5 50,25
0431 03 2325	15/16"x1"	331	14.2	14.6	36.5	39.5	495	5 58,55
0431 03 2631	1 1/16"x1 1/4"	371	15	16.7	40.5	48	640	5 70,60
0431 03 2833	1 1/8"x1 5/16"	371	15	16.7	40.5	48	660	5 70,60
0431 03 3033	1 3/16"x1 5/16"	371	16.4	16.7	45	48	670	5 75,35

ÖZEL SERİLER (adet ve termin süresi isteyiniz)

0431 03 1217	1/2"x11/16"	250	9	10	20	26.5	185	10 33,60
0431 03 1417	9/16"x11/16"	250	9.5	11.5	21.5	26.5	185	10 33,60
0431 03 1617	5/8"x11/16"	250	10.8	11.5	25	26.5	210	10 33,60
0431 03 1619	5/8"x3/4"	271	11.5	12.5	26.5	29	270	10 40,05
0431 03 2021	25/32"x13/16"	291	12.9	13.5	30.5	33	270	5 43,80
0431 03 1922	3/4"x7/8"	291	12.9	13.5	30.5	33	400	5 43,80
0431 03 2223	7/8"x15/16"	321	13.5	14.2	33	36.5	400	5 50,25
0431 03 2328	15/16"x1 1/8"	331	14.2	15	36.5	40.5	500	5 58,55
0431 03 2528	1"x1 1/8"	352	14.5	15.5	38	42.5	570	5 64,15
0431 03 3036	1 3/16"x1 3/8"	402	16.4	17.5	45	53	880	5 108,85
0431 03 3236	1 1/4"x1 7/16"	402	16.7	17.5	48	53	890	5 108,85
0431 03 3641	1 7/16"x1 5/8"	438	17.5	19.5	53	61	1100	5 147,95
0431 03 4146	1 11/16"x1 7/8"	485	19.5	20.5	61	67.5	1390	5 202,70
0431 03 4650	1 13/16"x2"	535	20.5	22.5	67.5	73.5	1955	5 322,55



KOD CODE	İÇERİK CONTENTS	g	TL/Ad.
0431 00 2108	1/4"x5/16" - 5/16"x3/8" 7/16"x1/2" - 9/16"x5/8" 19/32"x11/16" 3/4"x25/32" - 13/16"x7/8" 15/16"x1"	1915	8 288,60
0431 00 2112	1/4"x5/16" - 5/16"x3/8" 3/8"x7/16" - 7/16"x1/2" 9/16"x5/8" - 19/32"x11/16" 3/4"x25/32" - 13/16"x7/8" 15/16"x1" - 1 1/16"x1 1/4" 1 1/8"x1 5/16" 1 3/16"x1 5/16"	3985	12 531,20

0440

Düz Yıldız Anahtar (mm)  
Flat Ring Wrench (mm)

TS 3794  
TS ISO 10103  
DIN 838

2

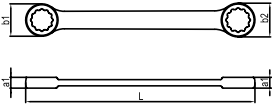

Krom vanadyum, Krom kaplı  
Chrom vanadium, Chrom plated

KOD CODE	mm	L mm	a1 mm	b1 mm	b2 mm	g	TL/Ad.
0440 03 0607	6x7	99	4.4	9.5	11	10	16,95
0440 03 0809	8x9	113	5.2	12.5	14	25	17,70
0440 03 1011	10x11	125	6	15.5	16.5	30	19,60
0440 03 1213	12x13	140	6.8	18.5	20	45	21,20
0440 03 1415	14x15	156	7.2	21	22.5	60	24,70
0440 03 1617	16x17	170	8	24	25	80	29,30
0440 03 1819	18x19	188	8.8	26.5	27.5	105	30,65
0440 03 2022	20x22	208	9.6	29	32	135	35,60
0440 03 2123	21x23	230	10.6	30	33	170	42,15
0440 03 2426	24x26	256	10.8	35	37.5	225	42,70
0440 03 2528	25x28	280	11.8	36	40.5	270	49,90
0440 03 2732	27x32	310	12.8	38.5	45.5	355	61,65

**ÖZEL SERİLER (adet ve termin süresi isteyiniz)**

0440 03 0810	8x10	120	5.6	12.5	15.5	30	10	18,95
0440 03 1013	10x13	140	6.6	15.5	20	45	10	21,20
0440 03 1315	13x15	156	7.2	20	22.5	55	10	24,70
0440 03 1317	13x17	170	8	20	25	85	10	29,30
0440 03 1618	16x18	188	8.6	24	26.5	90	10	30,65
0440 03 1719	17x19	188	8.8	25	27.5	105	10	30,65
0440 03 2224	22x24	230	10.8	32	35	170	10	42,15
0440 03 2427	24x27	256	10.8	35	38.5	225	10	42,70
0440 03 2729	27x29	290	12.8	38.5	42.5	285	10	57,05
0440 03 3032	30x32	310	12.8	43	45.5	360	10	61,65

0440

Düz Yıldız Anahtar Takımı (mm)  
Flat Ring Wrench, Set (mm)



KOD CODE	İÇERİK CONTENTS	g	TL/Ad.
0440 00 2108	6x7 - 8x9 - 10x11 - 12x13 - 14x15 16x17 - 18x19 - 20x22	560	8 195,70
0440 00 2112	6x7 - 8x9 - 10x11 - 12x13 - 14x15 16x17 - 18x19 - 20x22 - 21x23 24x26 - 25x28 - 27x32	1540	12 392,10

0435

Süper İzoleli Bir Ağız Yıldız Anahtar (mm)  
Single Ended Ring Wrench Super Insulated (mm)

2



Krom vanadyum, Krom kaplı, Kalın PVC izoleli  
Chrom vanadium, Chrom plated, Triple PVC insulated

KOD CODE	mm	L mm	g	TL/Ad.
0435 03 0010	10	170	100	36,95
0435 03 0011	11	180	110	36,95
0435 03 0012	12	190	130	41,90
0435 03 0013	13	200	150	41,90
0435 03 0014	14	215	180	44,00
0435 03 0017	17	230	220	49,85
0435 03 0019	19	245	270	59,50
0435 03 0022	22	260	310	65,20
0435 03 0024	24	280	420	87,15

0530

Yarım Ay Anahtar Yıldız İki Ağız (mm)  
Double - Hex Starter and Block Wrench (mm)

TSEK

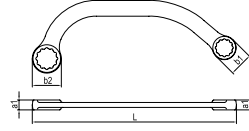

Krom vanadyum, Krom kaplı  
Chrom vanadium, Chrom plated

KOD CODE	mm	L mm	a1 mm	b1 mm	b2 mm	g	TL/Ad.
0530 04 0810	8x10	120	6	12.5	15.5	30	24,05
0530 04 1011	10x11	150	7	17	20	55	28,25
0530 04 1012	10x12	150	7	17	20	55	28,25
0530 04 1113	11x13	150	7	17	20	55	28,25
0530 04 1315	13x15	185	9	21.5	26	110	33,70
0530 04 1317	13x17	185	9	21.5	26	105	33,70
0530 04 1417	14x17	185	9	21.5	26	110	33,70
0530 04 1517	15x17	185	9	21.5	26	100	33,70
0530 04 1922	19x22	230	11	29	33	195	43,80

0540

Rekor Anahtar (mm)  
Flarenut Wrench (mm)

DIN 3118

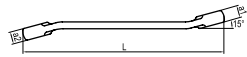
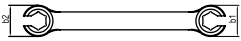

Krom vanadyum, Krom kaplı  
Chrom vanadium, Chrom plated

KOD CODE	mm	L mm	a1 mm	a2 mm	b1 mm	b2 mm	g	TL/Ad.
0540 01 0810	8x10	130	7	8.5	18	20	60	31,50
0540 01 1011	10x11	150	8.5	9.3	20	22	75	32,70
0540 01 1012	10x12	150	8.5	9.3	20	22	75	32,70
0540 01 1113	11x13	170	9.3	10.8	22	25.5	105	35,00
0540 01 1214	12x14	170	9.3	10.8	22	25.5	105	35,00
0540 01 1719	17x19	210	11.8	13	30.5	33.5	185	50,60
0540 01 1922	19x22	230	12.8	14.9	33.5	39.5	235	60,65

0531

Yarım Ay Anahtar Yıldız İki Ağız (SAE)  
Double - Hex Starter and Block Wrench (SAE)

TSEK

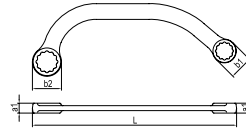

Krom vanadyum, Krom kaplı  
Chrom vanadium, Chrom plated

KOD CODE	inch	L mm	a1 mm	b1 mm	b2 mm	g	TL/Ad.
0531 04 1112	7/16"x1/2"	150	7	17	20	50	34,85
0531 04 1214	1/2"x9/16"	185	9	21.5	26	110	40,50
0531 04 1416	9/16"x5/8"	185	9	21.5	26	115	41,75
0531 04 1922	3/4"x7/8"	230	11	29	33	195	52,65

ÖZEL SERİLER (adet ve termin süresi isteyiniz)

0531 04 0809	5/16"x3/8"	120	6	12.5	15.5	30	28,80
0531 04 0911	3/8"x7/16"	150	7	17	20	50	33,90
0531 04 1417	9/16"x11/16"	185	9	21.5	26	110	40,40
0531 04 1517	9/32"x11/16"	185	9	21.5	26	105	40,40



## 0700

### Çatal Çakma Anahtar (mm) Slugging Open Jaw Wrench (mm)

TS 81  
DIN 133

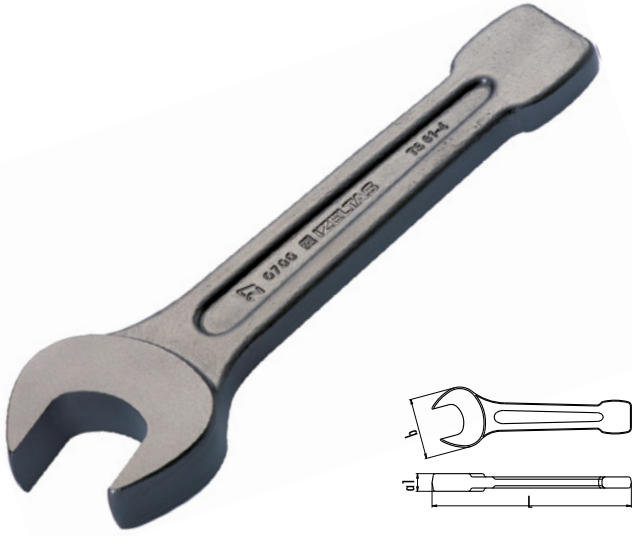

Krom vanadyum  
Chrom vanadium

KOD CODE	Ø mm	L mm	a1 mm	b mm	g	TL/Ad.
0700 05 0024	24	160	15	42	280	1 44,15
0700 05 0027	27	180	16	45	385	1 54,85
0700 05 0030	30	190	17	50	525	1 67,35
0700 05 0032	32	190	17	50	530	1 75,60
0700 05 0036	36	205	19	58	755	1 84,95
0700 05 0038	38	205	19	58	760	1 102,20
0700 05 0041	41	225	20	62	920	1 111,05
0700 05 0042	42	225	20	62	930	1 128,30
0700 05 0046	46	240	22	72	1305	1 141,20
0700 05 0047	47	240	22	72	1320	1 164,95
0700 05 0050	50	255	23	78	1565	1 176,45
0700 05 0055	55	272	25	88	2305	1 236,60
0700 05 0060	60	272	25	88	2310	1 256,80
0700 05 0065	65	300	28	98	3300	1 369,50
0700 05 0070	70	330	32	108	4555	1 473,05
0700 05 0075	75	330	32	108	4460	1 501,20
0700 05 0080	80	360	35	126	6115	1 637,40
0700 05 0085	85	360	35	126	5740	1 845,00
0700 05 0090	90	390	40	140	8040	1 869,40
0700 05 0095	95	390	40	140	8160	1 927,10
0700 05 0100	100	420	44	148	12355	1 1314,10
0700 05 0105	105	420	44	148	11785	1 1355,00
0700 05 0110	110	450	48	166	15000	1 1546,20
0700 05 0115	115	450	48	166	14830	1 1776,20
0700 05 0120	120	490	54	178	18865	1 1874,85

#### ÖZEL SERİLER (adet ve termin süresi isteyiniz)

0700 05 0125	125	490	54	178	17250	1	-----
0700 05 0130	130	518	59	196	20000	1	-----
0700 05 0135	135	518	59	196	19700	1	-----
0700 05 0140	140	518	59	196	19400	1	-----
0700 05 0145	145	580	62	223	28000	1	-----
0700 05 0150	150	580	62	223	27600	1	-----

## 0750

### Yıldız Çakma Anahtar (mm) Slugging Ring Wrench (mm)

TS 3794  
DIN 7444



Krom vanadyum  
Chrom vanadium

KOD CODE	Ø mm	L mm	a1 mm	b mm	g	TL/Ad.
0750 05 0024	24	160	15	42	235	1 61,95
0750 05 0027	27	180	16	46	325	1 73,90
0750 05 0030	30	190	17	52	435	1 88,25
0750 05 0032	32	190	17	52	425	1 101,35
0750 05 0036	36	205	19	59	550	1 114,70
0750 05 0038	38	205	19	59	530	1 137,40
0750 05 0041	41	225	20	64	730	1 150,00
0750 05 0042	42	225	20	64	700	1 171,55
0750 05 0046	46	240	22	73	970	1 179,40
0750 05 0047	47	240	22	73	930	1 197,95
0750 05 0050	50	255	23	78	1160	1 211,85
0750 05 0055	55	272	25	88	1520	1 298,00
0750 05 0060	60	272	25	88	1460	1 323,40
0750 05 0065	65	300	28	100	2025	1 422,80
0750 05 0070	70	330	32	109	2890	1 484,05
0750 05 0075	75	330	32	109	2755	1 518,05
0750 05 0080	80	360	35	123	4000	1 735,95
0750 05 0085	85	360	35	123	3620	1 828,05
0750 05 0090	90	390	40	142	5465	1 1018,60
0750 05 0095	95	390	40	142	5250	1 1148,55
0750 05 0100	100	420	44	152	6755	1 1327,80
0750 05 0105	105	420	44	152	6445	1 1370,60
0750 05 0110	110	450	46	165	8500	1 1465,20
0750 05 0115	115	450	46	165	8460	1 1642,45
0750 05 0120	120	490	54	178	10000	1 2257,40

#### ÖZEL SERİLER (adet ve termin süresi isteyiniz)

0750 05 0125	125	490	54	178	9900	1	-----
0750 05 0130	130	518	59	196	16000	1	-----
0750 05 0135	135	518	59	196	15900	1	-----
0750 05 0140	140	518	59	196	15800	1	-----
0750 05 0145	145	580	61.8	223	22000	1	-----
0750 05 0150	150	580	61.8	223	21900	1	-----
0750 05 0155	155	580	61.8	223	21800	1	-----
0750 05 0160	160	648	67	262	30100	1	-----
0750 05 0165	165	648	67	262	30000	1	-----
0750 05 0170	170	648	67	262	29800	1	-----
0750 05 0180	180	648	67	262	29700	1	-----

0550

Boru Uzatmalı Yıldız Anahtar (mm)  
Offset Ring Wrench (mm)

2

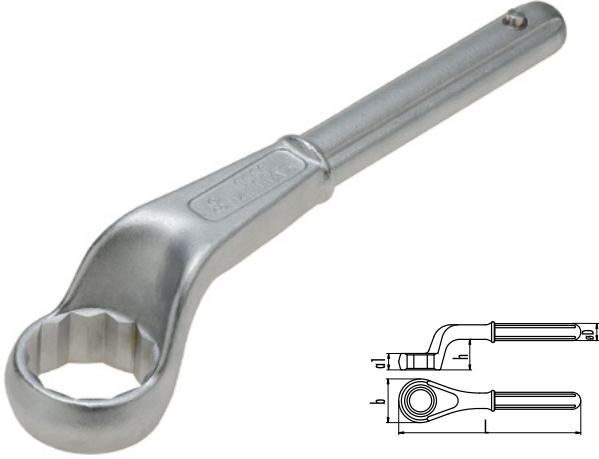

Krom vanadyum, Krom kaplı  
Chrom vanadium, Chrom plated

KOD CODE	mm	L mm	a1 mm	b mm	øD mm	h mm	g	TL/Ad.
0550 05 0024	24	180	17	37	18.5	30	400	1 64,70
0550 05 0027	27	190	18	42	18.5	33	450	1 77,10
0550 05 0030	30	200	20	46	18.5	34	520	1 92,10
0550 05 0032	32	235	21.5	49	21.2	37	700	1 105,80
0550 05 0036	36	245	23	53.5	21.2	42	830	1 119,70
0550 05 0038	38	270	25	60.5	21.2	42	965	1 138,10
0550 05 0041	41	270	25	60.5	21.2	43	950	1 156,50
0550 05 0046	46	280	26	68	24.2	45	1240	1 187,25
0550 05 0050	50	290	28	74	24.2	47	1410	1 221,10
0550 05 0055	55	300	30	79	24.2	50	1550	1 311,00
0550 05 0060	60	345	32	89	29	50.5	2390	1 337,50
0550 05 0065	65	355	35	98	29	53	2730	1 365,45

ÖZEL SERİLER (adet ve termin süresi isteyiniz)

0550 05 0022	22	180	17	37	18.5	30	400	1	----
0550 05 0034	34	235	21.5	49	21.2	37	750	1	----
0550 05 0070	70	365	37	104	29	55	2900	1	----
0550 05 0075	75	375	40	109	29	57.5	3100	1	----
0550 05 0080	80	385	43	124	29	59	3900	1	----
0550 05 0085	85	385	43	124	29	59	3750	1	----
0550 05 0090	90	410	46	140	29	63	5100	1	----
0550 05 0095	95	410	46	140	29	63	4950	1	----
0550 05 0100	100	420	46	150	29	65	4800	1	----

0551

Döndürme Kolu Borusu  
Tubular Handle

Dikişsiz Çelik Boru  
Seamless Steel Pipe

KOD CODE	mm	L mm	ø mm	g	TL/Ad.
0551 05 0001	22 - 30	460	19	700	1 57,45
0551 05 0002	32 - 41	610	22	1220	1 77,85
0551 05 0003	46 - 55	760	25	1880	1 116,75
0551 05 0004	60 - 100	860	30	2975	1 157,60

0600

Kurbağacak Anahtar  
Adjustable Wrench



TS 3796  
DIN 3117



Yedek parça sayfa 164  
Spare parts page 164

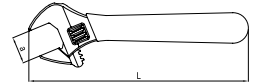

Krom vanadyum, Krom kaplı, PVC izoleli  
Chrom vanadium, Chrom plated, PVC insulated

KOD CODE	L mm	L inch	a mm	g	TL/Ad.
0600 01 1006	160	6"	18	120	5 61,50
0600 01 1008	208	8"	23	230	5 83,40
0600 01 1010	260	10"	28	400	5 107,50
0600 01 1012	308	12"	34	670	5 148,70
0600 01 1015	388	15"	43	1555	1 233,05

0860

Kanca Anahtar (dörtgen uçlu)  
Hook Wrench

TS 3798 • DIN 1810

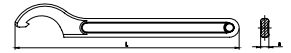

Krom vanadyum, Krom kaplı  
Chrom vanadium, Chrom plated

KOD CODE	mm	L mm	a1 mm	g	TL/Ad.
0860 05 2528	25/28	136	5	50	10 31,70
0860 05 3032	30/32	136	5	50	10 31,70
0860 05 3436	34/36	170	6	95	10 34,30
0860 05 4042	40/42	170	6	95	10 34,30
0860 05 4550	45/50	210	7	160	10 39,80
0860 05 5255	52/55	210	7	160	10 39,80
0860 05 5862	58/62	242	8	270	5 48,00
0860 05 6875	68/75	242	8	270	5 48,00
0860 05 8090	80/90	281	9	400	5 62,65
0860 05 9510	95/100	281	9	400	5 62,65

0615

Ayarlı Montaj Anahtarı  
Adjustable Speed Wrench

R&D  
AR-GE



Yedek parça sayfa 164  
Spare parts page 164

Krom vanadyum, Krom kaplı  
Chrom vanadium, Chrom plated

KOD CODE	L mm	L inch	a mm	g	TL/Ad.
0615 01 0200	200	8"	6-22	220	5 104,05

6 ile 22 mm arası **altı köşe, torx, yive, ribe, kare** gibi farklı geometriye sahip civataları açabilme imkanı sağlar. Anahtarı civata başından tam olarak çıkarmadan açma ve sıkma hareketi olanağı sağlar. Anahtar sapına özel olarak açılmış 10-13-15 mm altı köşe civataları açabilme imkanı sağlar



## MCD MULTI CONTACT DRIVE PROFILE / MCD ÇOK NOKTADAN TEMAS PROFİLİ



### İzeltas Yeni Jenerasyon Yıldız Anahtar Profili

MCD, Multi Contact Drive (çoklu temas), sıkma performansının geliştirilmesi amacıyla dizayn edilmiştir. Bilgisayar destekli titiz çalışmaların sonucunda geliştirilen MCD, klasik 12 köşe anahtardan çok daha kullanışlı, çok daha güçlüdür.

En önemli özelliği, yıldız kafadaki çoklu temas yüzeyleridir. Bu sayede civata ve somunla maksimum temas sağlanır. Böylece basınç tüm köşelere eşit olarak dağılır, temas edilen yüzeylerdeki olası hasarlar önlenir, aletin ömrü uzar.

- Yıldız kafadaki yeni profil, düzenli bir dalga şeklindedir. Güç, civatanın köşelerine değil, yan yüzeylerine etki eder (çoklu temas). Basınç daha dengeli dağıldığından temas edilen yüzeylerde ezilme meydana gelmez.
- Tolerans dışı civatalar için de uygundur.
- Civata başlarının köşelerini ezmez.
- Geniş temas alanı, anahtar ömrünü artırır.
- Bozuk ve deforme olmuş civataları kolayca açar.

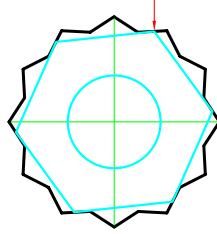

Çoklu Temas / Multi Point Contact

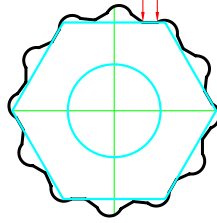

MCD Profil  
MCD Profile

### IZELTAS New Generation Ring Wrench Profile

MCD (Multi Contact Drive) is designed to improve the driving performance of the ring wrench. MCD, designed through computer aided drafting, transmits more torque and has longer life than conventional 12 edge ring profile.

Multi point contact is the source of effectiveness, where maximum surface area is in touch with fastener flats. Increased contact also maximizes tool's life through decreased pressure on the contact points.

- New profile of the ring wrench is formed of curves. Torque is transmitted through these curves rather than edges. As the stress is balanced between enlarged surfaces, the risk of deformation is minimized.
- It is possible to drive off-tolerance fasteners.
- Does not deform the fastener edges.
- Larger contact area increases tool's life.
- Works well with deformed fasteners.

## MONTAJ ANAHTARI / SPEED WRENCH



### %100 Daha Hızlı

Yeni tasarlanan montaj anahtarı, 2 kat hızlı cırcır mekanizması mantığına dayanan çalışma prensibinden alır. Kullanım sırasında, montaj anahtarını civatadan ayırmadan döndürme kolaylığı kullanım hızını artırırken, civata köşelerine sağlam tutunan anahtar profili güvenli ve kaydırmaz kullanım sağlar.

### Uzun Ömür

Bu yeni montaj anahtarı profili, civata ve somunlar ile köşelerinden değil düz yüzeyleri üzerinden temas ederek düzenli tork iletimini sağlarken, gerilimin artmasını da engelleyerek anahtar ömrünün uzamasını sağlar.

- Anahtarı civatadan ayırmadan hızlı kullanım.
- Güvenli tork iletimi ve uzun ömür.

### 100% Faster

New designed speed wrench takes its 100% faster rotational drive from the ratchet mechanism principle. Rotating the tool without the need for removing from the fastener provides faster usage, while enabling safer and slip-free usage with fully gripping upper and lower jaws.

### Longer Tool Life

This new speed wrench profile contacts the fasteners from their flats rather than edges, which provides balanced torque transmission and decreases stress accumulation on the edges increasing the tool life considerably.

- Fast drive without removing the wrench from the fastener.
- Firm torque transmission and longer life.

## AYARLI MONTAJ ANAHTARI / ADJUSTABLE SPEED WRENCH



6 ile 22 mm arası altı köşe, torx,yive ,ribe, kare gibi farklı geometriye sahip civataları açabilme imkanı sağlar. Anahtarı civata başından tam olarak çıkarmadan açma ve sıkma hareketi olanağı sağlar. Anahtar sapına özel olarak açılmış 10-13-15 mm altı köşe civataları açabilme imkanı sağlar

This tool is used for all different shapes of bolts between 6 and 22 mm. Contact between the tool and bolt is not removed to loosen and tighten the bolt. With the hexagonal holes in the handle, tool also can be used for 10-13-15mm bolts and nuts.

# 3

## Lokma ve Bijon Anahtarları Sockets and Rim Wrenches



- Lokma Anahtarlar* Socket Wrenches
- Lokma Takımları* Socket Wrench Sets
- Kovan Anahtarlar* Tubular Socket Wrenches
- Bijon Anahtarlar* Rim Wrenches
- Tork Anahtarları* Torque Wrenches

1107

1/4" Altı Köşe Lokma Anahtar (mm)  
Socket Wrench 6 Points (mm)

TS ISO 2725 -1  
DIN 3124

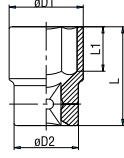

1/4"

Krom vanadyum, Krom kaplı, Polisajlı  
Chrom vanadium, Chrom plated, Polished

KOD CODE	mm	σ D1 mm	σ D2 mm	L mm	L1 mm	g	TL/Ad.
1107 06 0004	4	6.8	11.8	24.5	4	10	3,60
1107 06 0045	4.5	7.4	11.8	24.5	5	10	3,60
1107 06 0005	5	8	11.8	24.5	6	10	3,60
1107 06 0055	5.5	8.7	11.8	24.5	6	10	3,60
1107 06 0006	6	9.2	11.8	24.5	7	10	3,60
1107 06 0007	7	10.3	11.8	24.5	7	10	3,60
1107 06 0008	8	11.4	11.8	24.5	8	10	3,60
1107 06 0009	9	12.9	12.2	24.5	8	15	3,80
1107 06 0010	10	14.3	13	24.5	9	20	3,80
1107 06 0011	11	15.8	14.2	24.5	9	20	4,80
1107 06 0012	12	16.8	15.5	24.5	9	25	4,80
1107 06 0013	13	17.8	16.5	24.5	9	30	5,40



Havali aletler ile kullanmayınız / Do not use with power-tools

1107

1/4" Altı Köşe Derin Lokma Anahtar (mm)  
Deep Socket Wrench 6 Points (mm)

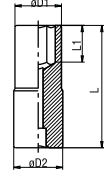

1/4"

Krom vanadyum, Krom kaplı, Polisajlı  
Chrom vanadium, Chrom Plated, Polished

KOD CODE	mm	σ D1 mm	σ D2 mm	L mm	L1 mm	g	TL/Ad.
1107 06 4004	4	6.8	11.8	50	6	10	7,10
1107 06 4005	5	8	11.8	50	7	20	7,10
1107 06 4055	5.5	8.7	11.8	50	9	20	7,10
1107 06 4006	6	9.2	11.8	50	9	25	7,95
1107 06 4007	7	10.3	11.8	50	15	25	7,95
1107 06 4008	8	11.8	11.8	50	15	25	7,95
1107 06 4009	9	13	13	50	15	30	7,95
1107 06 4010	10	14.5	14.5	50	15	40	7,95
1107 06 4011	11	15.8	15.8	50	21	45	8,60
1107 06 4012	12	16.8	16.8	50	21	50	8,60
1107 06 4013	13	17.8	17.8	50	21	55	8,60

1107

1/4" Derin Lokma Anahtar Takımı (14 parça, mm)  
Socket Wrench Set Long Type (14 pcs, mm)



1/4"

KOD CODE	LOKMALAR Sockets	AVADANLIKLAR Accessories	g	TL/Ad.
1107 00 6014	4-5-5.5-6 7-8-9-10 11-12-13 Altı Köşe Derin Lokma Deep Socket Wrench 6 Points	1/4" Cırcır Kol Ratchet Handle 1/4" Ara Kol Extension Bar 50 mm 1/4" Ara Kol Extension Bar 100 mm	1005	14 161,90

1107

1/4" Lokmalı Allen Uç  
Hexagonal Bit Socket Wrench



1/4"

Krom vanadyum, Krom Kaplı  
Chrom vanadium, Chrom Plated

KOD CODE	mm	L mm	g		TL/Ad.
1107 06 1125	2.5	37	13	10	5,90
1107 06 1103	3	37	13	10	5,90
1107 06 1104	4	37	15	10	5,90
1107 06 1105	5	37	15	10	5,90
1107 06 1106	6	37	15	10	5,90
1107 06 1107	7	37	16	10	7,00
1107 06 1108	8	37	17	10	7,00
1107 06 1110	10	37	19	10	8,40

1107

1/4" Lokmalı Star Delikli (Torx®) Uç  
Tamper Resistant Torx Bit Socket Wrench



1/4"

Krom vanadyum, Krom Kaplı  
Chrom vanadium, Chrom Plated

KOD CODE		L mm	g		TL/Ad.
1107 06 1308	TR8	37	13	10	7,10
1107 06 1309	TR9	37	13	10	7,10
1107 06 1310	TR10	37	13	10	7,10
1107 06 1315	TR15	37	14	10	7,10
1107 06 1320	TR20	37	14	10	7,10
1107 06 1325	TR25	37	14	10	7,10
1107 06 1327	TR27	37	14	10	7,10
1107 06 1330	TR30	37	15	10	7,10
1107 06 1340	TR40	37	16	10	8,30

1107

1/4" Lokmalı Star (Torx®) Uç  
Torx Bit Socket Wrench



1/4"

Krom vanadyum, Krom Kaplı  
Chrom vanadium, Chrom Plated

KOD CODE		L mm	g		TL/Ad.
1107 06 1208	T8	37	12	10	6,10
1107 06 1209	T9	37	12	10	6,10
1107 06 1210	T10	37	13	10	6,10
1107 06 1215	T15	37	14	10	6,10
1107 06 1220	T20	37	14	10	6,10
1107 06 1225	T25	37	14	10	6,10
1107 06 1227	T27	37	14	10	6,10
1107 06 1230	T30	37	15	10	6,10
1107 06 1240	T40	37	16	10	6,10

1107

1/4" Lokma Düz Uç  
Slotted Bit Socket Wrench



1/4"

Krom vanadyum, Krom Kaplı  
Chrom vanadium, Chrom Plated

KOD CODE		L mm	g		TL/Ad.
1107 06 1403	3	37	13	10	5,90
1107 06 1435	3.5	37	14	10	5,90
1107 06 1404	4	37	14	10	5,90
1107 06 1445	4.5	37	14	10	5,90
1107 06 1455	5.5	37	15	10	5,90
1107 06 1465	6.5	37	15	10	5,90
1107 06 1407	7	37	16	10	5,90
1107 06 1408	8	37	16	10	6,80
1107 06 1410	10	37	17	10	7,35

1107

1/4" Lokmalı Yıldız Uç  
Phillips Bit Socket Wrench

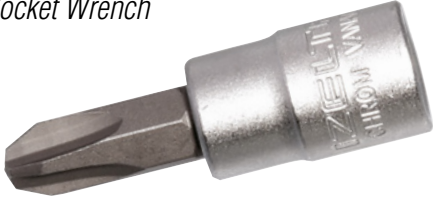

1/4"

Krom vanadyum, Krom Kaplı  
Chrom vanadium, Chrom Plated

KOD CODE	+	L mm	g	TL/Ad.	
1107 06 1501	Ph 1	37	14	10	5,90
1107 06 1502	Ph 2	37	14	10	5,90
1107 06 1503	Ph 3	37	15	10	5,90
1107 06 1504	Ph 4	37	16	10	5,90

1107

1/4" Bits Uçlu Lokma Takımı (42 Parça)  
Bit Socket Wrench Set (42 Pcs)



1/4"

KOD CODE	İÇERİK CONTENTS	TL/Ad.
1107 00 1042	<b>1/4" Lokmalı Star Torx® Uçlar</b> Torx® Bit Socket T8-T9-T10-T15-T20-T25-T27-T30-T40	42 336,05
	<b>1/4" Lokmalı Star Delikli Torx® Uçlar</b> Tamper Resistant Torx® Bit Socket Wrench TR8-TR9-TR10-TR15-TR20 -TR25-TR27-TR30-TR40	
	<b>1/4" Lokmalı Allen Uçlar</b> Hexagonal Bit Socket Wrench 2.5-3-4-5-6-7-8-10	
	<b>1/4" Lokmalı Düz Uç</b> Slotted Bit Socket Wrench 3-3.5-4-4.5-5.5 6.5-7-8-10	
	<b>1/4" Lokmalı Yıldız Uç</b> Phillips Bit Socket Wrench Ph1-Ph2-Ph3-Ph4	
	<b>1/4" Cırcır kolu</b> Ratchet Handle	
	<b>1/4" Ara Kol</b> Extension Bar 100 mm	
	<b>1/4" Lokma Tornavida Adaptörü</b> Spindle Handle	

1507

1/4" Cırcır Kolu (Plastik Saplı)  
Ratchet Wrench (Plastic Handle)

TS ISO 3315



1/4"

Krom vanadyum, Krom kaplı, Polisajlı  
Chrom vanadium, Chrom plated, Polished

KOD CODE	L mm	g	TL/Ad.
1507 06 2140	195	140	5 73,85

1507

1/4" Cırcır Kolu  
Ratchet Handle

TS ISO 3315  
DIN 3122

1/4"



Krom vanadyum, Krom kaplı, Polisajlı  
Chrom vanadium, Chrom plated, Polished

KOD CODE	L mm	g	TL/Ad.
1507 06 0140	140	140	5 53,65

1507

1/4" Ara Kol  
Extension Bar

TS ISO 1174  
DIN 3123

1/4"



Krom vanadyum, Krom kaplı, Polisajlı  
Chrom vanadium, Chrom plated, Polished

KOD CODE	L mm	g	TL/Ad.
1507 06 0050	50	25	5 10,25
1507 06 0100	100	45	5 11,15

1507

1/4" Mafsal  
Universal Joint

TS ISO 1174  
DIN 3123

1/4"



Krom vanadyum, Krom kaplı, Polisajlı  
Chrom vanadium, Chrom plated, Polished

KOD CODE	L mm	g	TL/Ad.
1507 06 0038	38	25	5 18,80



## 1507

1/4" T Kol  
Sliding T - Handle

TS ISO 3315  
DIN 3122



## 1/4"

Krom vanadyum, Krom kaplı, Polisajlı  
Chrom vanadium, Chrom plated, Polished

KOD CODE	L mm	g		TL/Ad.
1507 06 4115	115	45	5	16,30

## 1507

1/4" Lokma Adaptörü  
Adapter

TS ISO 1174  
DIN 3123



## 1/4"

Krom vanadyum, Krom kaplı, Polisajlı  
Chrom vanadium, Chrom plated, Polished

KOD CODE	inch	g		TL/Ad.
1507 06 0004	1/4"Fx3/8"M	20	5	12,35

## 1507

1/4" Derin Lokma Tornavida Adaptörü  
Spindle Handle

DIN 3122



## 1/4"

Krom vanadyum, Krom kaplı, Polisajlı, Selüloz Asetat Saplı  
Chrom vanadium, Chrom plated, Polished, Cellulose Acetate Handle

KOD CODE	L mm	L1 mm	g		TL/Ad.
1507 06 4080	150	65	100	10	20,30

## 1107

1/4" Karbüratör Lokma Takımı (18 parça, mm)  
Socket Wrench Set (18 pcs, mm)



## 1/4"

KOD CODE	LOKMALAR Sockets	AVADANLIKLAR Accessories	g		TL/Ad.
		1/4" Cırcır kolu Ratchet Handle			
		1/4" Mafsal Universal Joint			
	4 - 5 - 6 7 - 8 - 9 - 10 11 - 12 - 13 Altı Köşe Six Points	1/4" T Kol Sliding T Handle	960	18	211,60
1107 00 6018	8 - 10 Sekiz Köşe Eight Points	1/4" Ara Kol Extension Bar 50 mm			
		1/4" Ara Kol Extension Bar 100 mm			
		1/4" Mafsalı Kol Flexible Handle			

1110

3/8" Altı Köşe Lokma Anahtar (mm)  
Socket Wrench 6 Points (mm)

TS ISO 2725 - 1  
DIN 3124

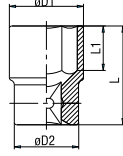

3/8"

Krom vanadyum, Krom kaplı, Polisajlı  
Chrom vanadium, Chrom plated, Polished

KOD CODE	mm	Ø D1 mm	Ø D2 mm	L mm	L1 mm	g	TL/Ad.
1110 06 0006	6	9.8	17.8	27	9	25	10, 9,85
1110 06 0007	7	10.8	17.8	27	9	25	10, 9,85
1110 06 0008	8	12	17.8	27	9	25	10, 9,85
1110 06 0009	9	13.2	17.8	27	9	25	10, 9,85
1110 06 0010	10	14.5	17.8	27	9	25	10, 9,85
1110 06 0011	11	15.8	17.8	27	9	30	10, 9,85
1110 06 0012	12	16.8	17.8	27	9	30	10, 9,85
1110 06 0013	13	17.8	16.8	27	9	30	10, 10,60
1110 06 0014	14	19.6	17.5	29	11	35	10, 10,60
1110 06 0015	15	20.8	18	29	11	45	10, 10,60
1110 06 0016	16	21.8	19	29	11	45	10, 11,10
1110 06 0017	17	23.4	20	29	11	55	10, 11,10
1110 06 0018	18	24.7	21	29	13	60	10, 11,10
1110 06 0019	19	25.8	22	29	13	65	10, 12,80
1110 06 0021	21	27.8	24	32	13	80	10, 13,90
1110 06 0022	22	29.7	26	32	15	85	10, 14,90
1110 06 0023	23	29.7	26	32	15	90	10, 14,90

1110

3/8" Buji Lokma Anahtar Lastikli  
Spark Plug Socket with Rubber

TS ISO 2725 - 1



3/8"

Krom vanadyum, Krom kaplı, Polisajlı  
Chrom vanadium, Chrom plated, Polished

KOD CODE	mm	L mm	g	TL/Ad.
1110 06 9208	21	70	145	10, 16,95

1510

3/8" Cırcır Kolu  
Ratchet Handle

TS ISO 3315  
DIN 3122



3/8"

Krom vanadyum, Krom kaplı, Polisajlı  
Chrom vanadium, Chrom plated, Polished

KOD CODE	L mm	g	TL/Ad.
1510 06 0200	200	295	5, 118,80

1510

3/8" Ara Kol  
Extension Bar

TS ISO 1174  
DIN 3123



3/8"

Krom vanadyum, Krom kaplı, Polisajlı  
Chrom vanadium, Chrom plated, Polished

KOD CODE	L mm	g	TL/Ad.
1510 06 0075	75	75	5, 18,90
1510 06 0150	150	145	5, 28,65

1510

3/8" Mafsal  
Universal Joint

TS ISO 1174  
DIN 3123



3/8"

Krom vanadyum, Krom kaplı, Polisajlı  
Chrom vanadium, Chrom plated, Polished

KOD CODE	L mm	g	TL/Ad.
1510 06 0056	56.5	60	5, 30,75

**1510**

3/8" T Kol  
Sliding T - Handle

TS ISO 3315  
DIN 3122



**3/8"**

Krom vanadyum, Krom kaplı, Polisajlı  
Chrom vanadium, Chrom plated, Polished

KOD CODE	L mm	g	TL/Ad.
1510 06 1200	200	180	5 36,65

**1510**

3/8" Lokma Adaptörü  
Adapter

TS ISO 1174  
DIN 3123



**3/8"**

Krom vanadyum, Krom kaplı, Polisajlı  
Chrom vanadium, Chrom plated, Polished

KOD CODE	inch	g	TL/Ad.
1510 06 0007	3/8"Fx1/2"M	45	5 21,10



**1110**

3/8" Altı Köşe Lokma Takımı (20 parça, mm)  
6 Points Socket Wrench Set (20 Pcs, mm)



3



**3/8"**

KOD CODE	LOKMARLAR Sockets	AVADANLIKLAR Accessories	g	TL/Ad.
		<b>3/8" Cırcır Kolu</b> Ratchet Handle		
		<b>3/8" Mafsallı</b> Universal Joint		
	6 - 7 - 8 - 9 10 - 11 - 12 13 - 14 - 17 19 - 21 - 23	<b>3/8" T Kol</b> Sliding T Handle		
1110 00 6020	<b>Altı Köşe</b> Six Points 20.8	<b>3/8" Ara Kol</b> Extension Bar 75 mm	2500	20 459,35
	<b>Buji Lokma</b> <b>Lastikli</b> <b>Altı Köşe</b> Spark Plug Socket With Rubber	<b>3/8" Ara Kol</b> Extension Bar 150 mm		
		<b>3/8" Mafsallı Kol</b> Flexible Handle		

Havali aletler ile kullanmayınız / Do not use with power-tools

1/2" Lokma Anahtar Sehpası (145 Parça)  
Display Frame for Sockets (145 Pcs)

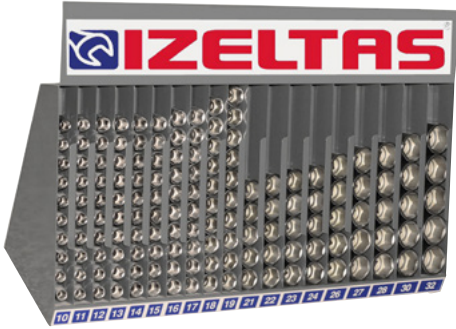

1/2"

1/2" Altı Köşe Lokma Anahtar (mm)  
Socket Wrench 6 Points (mm)

TS ISO 2725 -1  
DIN 3124

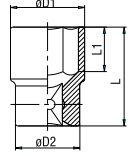

1/2"

Krom vanadyum, Krom kaplı  
Chrom vanadium, Chrom plated

KOD CODE	İÇERİK CONTENTS	g		TL/Ad.
	<b>Dolu/Full</b>			
	10-11-12 13-14-15 16-17-18-19 10 adet /10 Pcs			
1113 00 6145		18.236	1	2863,55
	21-22-23 24-26-27 28-30-32 5 Adet / 5 Pcs			

KOD CODE	mm	ø D1 mm	ø D2 mm	L mm	L1 mm	g		TL/Ad.
1113 06 1008	8	13.2	21.8	38	7	55	10	12,00
1113 06 1009	9	14	21.8	38	7	55	10	12,00
1113 06 1010	10	15	23.3	38	8	55	10	14,95
1113 06 1011	11	16.4	23.3	38	8	60	10	14,95
1113 06 1012	12	17.8	23.3	38	9	60	10	14,95
1113 06 1013	13	19	23.3	38	10	65	10	16,05
1113 06 1014	14	20.4	23.3	38	11	65	10	16,05
1113 06 1015	15	21.6	23.3	38	11	65	10	16,05
1113 06 1016	16	22.9	24	38	11	70	10	16,80
1113 06 1017	17	24	22.5	38	12	70	10	16,80
1113 06 1018	18	25.2	23	38	13	75	10	16,80
1113 06 1019	19	26.8	23	38	13	75	10	17,55
1113 06 1020	20	28	23	38	13	80	10	17,55
1113 06 1021	21	29.2	23	38	13	85	5	17,55
1113 06 1022	22	30.2	24	40	15	95	5	17,55
1113 06 1023	23	31.4	25	40	15	100	5	18,30
1113 06 1024	24	32.6	26	42	17	115	5	18,30
1113 06 1025	25	34	27	42	17	125	5	18,30
1113 06 1026	26	35.3	28	42	17	135	5	18,30
1113 06 1027	27	36.6	28	42	19	140	5	21,00
1113 06 1028	28	37.8	30	42	20	160	5	21,00
1113 06 1029	29	39	30	44	21	170	5	22,10
1113 06 1030	30	40	29.5	44	21	180	5	22,10
1113 06 1032	32	42.5	30	44	23	190	5	23,00



## 1114

### 1/2" On İki Köşe Lokma Anahtar (mm) Socket Wrench 12 Points (mm)

TS ISO 2725 - 1  
DIN 3124

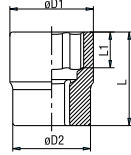

1/2"

Krom vanadyum, Krom kaplı  
Chrom vanadium, Chrom plated

KOD CODE	Ø mm	ø D1 mm	ø D2 mm	L mm	L1 mm	g	TL/Ad.	
1114 06 1010	10	15	23.3	38	8	60	10	15,95
1114 06 1011	11	16.4	23.3	38	8	60	10	15,95
1114 06 1012	12	17.8	23.3	38	9	60	10	15,95
1114 06 1013	13	19	23.3	38	10	60	10	17,20
1114 06 1014	14	20.4	23.3	38	11	60	10	17,20
1114 06 1015	15	21.6	23.3	38	11	65	10	17,20
1114 06 1016	16	22.9	24	38	11	70	10	17,95
1114 06 1017	17	24	22.5	38	12	70	10	17,95
1114 06 1018	18	25.2	23	38	13	70	10	17,95
1114 06 1019	19	26.8	23	38	13	75	10	18,75
1114 06 1020	20	28	23	38	13	80	10	18,75
1114 06 1021	21	29.2	23	38	13	80	5	18,75
1114 06 1022	22	30.2	24	40	15	95	5	18,75
1114 06 1023	23	31.4	25	40	15	100	5	19,60
1114 06 1024	24	32.6	26	42	17	105	5	19,60
1114 06 1026	26	35.3	28	42	17	135	5	19,60
1114 06 1027	27	36.6	28	42	19	135	5	22,45
1114 06 1028	28	37.8	30	42	20	155	5	22,45
1114 06 1030	30	40	30	44	21	165	5	23,55
1114 06 1032	32	42.5	30	44	23	180	5	24,70



Havale aletler ile kullanmayınız / Do not use with power-tools

## 1413

### 1/2" On İki Köşe Lokma Anahtar (SAE) Socket Wrench 12 Points (SAE)

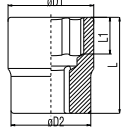

1/2"

Krom vanadyum, Krom kaplı  
Chrom vanadium, Chrom plated

KOD CODE	Ø inch	ø D1 mm	ø D2 mm	L mm	L1 mm	g	TL/Ad.	
1413 06 1008	5/16"	13.2	21.8	37	6	45	10	17,10
1413 06 1095	3/8"	15	21.8	37	8	50	10	17,10
1413 06 1010	7/16"	16.4	23.3	37	9	60	10	17,70
1413 06 1011	15/32"	18	23.3	37	9	60	10	17,70
1413 06 1012	1/2"	19	23.3	37	9	60	10	18,40
1413 06 1013	9/16"	20.4	23.3	37	11	60	10	19,05
1413 06 1014	19/32"	21.6	23.3	37	11	65	10	19,05
1413 06 1015	5/8"	23.1	22	38	11	70	10	19,25
1413 06 1016	11/16"	24.5	22.5	38	11	70	10	19,90
1413 06 1017	3/4"	26.8	23	38	13	75	10	20,10
1413 06 1020	25/32"	28	23	38	13	75	10	20,80
1413 06 1021	13/16"	28.6	23	38	13	80	10	20,80
1413 06 1022	7/8"	30.2	24	40	15	90	5	20,80
1413 06 1024	15/16"	32.6	26	42	17	115	5	21,75
1413 06 1025	1"	35	28	42	17	130	5	21,75
1413 06 1027	1 1/16"	36.6	28	42	19	135	5	28,55
1413 06 1029	1 1/8"	38.8	30	42	19	170	5	28,55
1413 06 1030	1 3/16"	40	29.5	44	20	170	5	28,55
1413 06 1032	1 1/4"	42.5	30	44	22	185	5	28,55

## 1113

### 1/2" Buji Lokma Anahtar (Lastikli) Spark Plug Socket with Rubber



1/2"

Krom vanadyum, Krom kaplı, Polisajlı  
Chrom vanadium, Chrom plated, Polished

KOD CODE	Ø mm	L mm	g	TL/Ad.	
1113 06 9160	16	70	80	10	20,50
1113 06 9208	21	70	155	10	22,50

1108

1/2" Altı Köşe Derin Lokma Anahtar (mm)  
Deep Socket Wrench 6 Points (mm)

TS ISO 2725 - 1  
DIN 3124

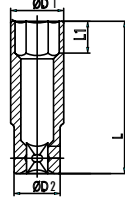

Krom vanadyum, Krom kaplı  
Chrom vanadium, Chrom plated

1/2"

KOD CODE	mm	ØD1 mm	ØD2 mm	L mm	L1 mm	g	TL/Ad.
1108 06 0010	10	15,5	24	75	6	110	29,85
1108 06 0011	11	16,7	24	75	7	110	29,85
1108 06 0012	12	18	24	75	8	110	29,85
1108 06 0013	13	19,2	24	75	8	120	32,05
1108 06 0014	14	20,5	24	75	10	120	32,05
1108 06 0015	15	21,7	24	75	10	140	32,05
1108 06 0016	16	23	25,5	75	10	140	33,55
1108 06 0017	17	24,2	25,5	75	10	140	33,55
1108 06 0018	18	25,5	25,5	75	12	150	33,55
1108 06 0019	19	26,7	26,7	75	12	150	35,05

1108

1/2" Altı Köşe Derin Lokma Anahtar Takımı (10 parça mm)  
Deep Socket Set (10 pcs. mm)



1/2"

KOD CODE	L mm	g	TL/Ad.
1108 00 6010	10-11-12-13-14-15 16-17-18-19	1290	10 353,45

1113

1/2" Star Lokma Anahtar  
Star Socket

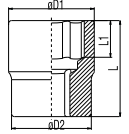

1/2"

Krom vanadyum, Krom kaplı  
Chrom vanadium, Chrom plated

KOD CODE	mm	Ø D1 mm	Ø D2 mm	L mm	L1 mm	g	TL/Ad.
1113 06 0210	E10	13.2	23.8	37	7.5	60	14,55
1113 06 0212	E12	15	23.8	37	9	65	14,55
1113 06 0214	E14	16.4	23.8	37	10	65	14,55
1113 06 0216	E16	18.8	23.8	37	11	70	14,55
1113 06 0218	E18	20.5	23.8	39	12.5	75	14,55
1113 06 0220	E20	23	23.8	39	14	75	16,35

1113

1/2" Star (Torx®) Lokma Anahtar Takımı (7 Parça)  
Star Torx® Socket Wrench Set (7 Pcs)



1/2"

KOD CODE	İÇERİK CONTENTS	g	TL/Ad.
1113 00 6007	Star Lokma / Star Socket E10 - E12 - E14 - E16 - E18 - E20 125 mm ara kol / Extension Bar	1075	7 118,70

1113

1/2" Lokmalı Allen Uç  
Hexagonal Bit Socket Wrench



1/2"

Krom vanadyum, Krom kaplı  
Chrom vanadium, Chrom plated

KOD CODE	mm	L mm	g	TL/Ad.	
1113 06 1105	5	60	70	10	19,40
1113 06 1106	6	60	70	10	19,40
1113 06 1107	7	60	75	10	19,40
1113 06 1108	8	60	75	10	19,40
1113 06 1110	10	60	85	10	22,15
1113 06 1112	12	60	100	10	22,15
1113 06 1114	14	60	115	10	22,15
1113 06 4105	5	100	90	10	20,25
1113 06 4106	6	100	90	10	20,25
1113 06 4107	7	100	90	10	20,25
1113 06 4108	8	100	95	10	20,25
1113 06 4110	10	100	105	10	23,40
1113 06 4112	12	100	145	10	23,40
1113 06 4114	14	100	155	10	28,25
1113 06 4117	17	100	200	10	37,75

1113

1/2" Lokmalı Star (Torx®) Uç  
Star (Torx) Bit Socket Wrench



1/2"

Krom vanadyum, Krom kaplı  
Chrom vanadium, Chrom plated

KOD CODE	★	L mm	g	TL/Ad.	
1113 06 1220	T20	60	70	10	23,95
1113 06 1225	T25	60	70	10	23,95
1113 06 1227	T27	60	70	10	23,95
1113 06 1230	T30	60	70	10	23,95
1113 06 1240	T40	60	70	10	23,95
1113 06 1245	T45	60	70	10	23,95
1113 06 1250	T50	60	75	10	23,95
1113 06 1255	T55	60	80	10	23,95
1113 06 1260	T60	60	100	10	23,95
1113 06 4220	T20	100	78	10	24,95
1113 06 4225	T25	100	79	10	24,95
1113 06 4227	T27	100	80	10	24,95
1113 06 4230	T30	100	80	10	24,95
1113 06 4240	T40	100	80	10	24,95
1113 06 4245	T45	100	82	10	24,95
1113 06 4250	T50	100	82	10	24,95
1113 06 4255	T55	100	100	10	24,95
1113 06 4260	T60	100	134	10	24,95

3

1113

1/2" Lokmalı Allen Uç Takımı (60 mm, 7 Parça)  
Hexagonal Bits Socket Wrench Set (60 mm, 7 Pcs)

YENİ  
NEW



1/2"

KOD CODE	İÇERİK CONTENTS	g	TL/Ad.	
1113 00 1107	Allen Uçlar 60mm Hex Bit Socket 5-6-7-8-10-12-14	1040	7	144,05

1113

1/2" Lokmalı Torx® Uç Takımı (60 mm, 9 parça)  
Torx® Bits Socket Wrench Set (60 mm, 9 Pcs)

YENİ  
NEW



1/2"

KOD CODE	İÇERİK CONTENTS	g	TL/Ad.	
1113 00 6009	Torx® Uçlar 60mm Star Socket T20 - T25 - T27 - T30 - T40 - T45 T50 - T55 - T60	1125	9	215,55

1113

1/2" Lokmalı Allen Uç ve Star (Torx)® Uç Takımı (17 Parça)  
Hex Bit Sockets - Torx Bit Sockets Set (17 Pcs)

3



1/2"



KOD CODE	İÇERİK CONTENTS		TL/Ad.
1113 00 6017	<p><b>T Kol (1/2")</b> Sliding T Handle 5 - 6 - 7 - 8 - 10 - 12 - 14</p> <p><b>Lokmalı Allen Uç 60mm</b> Hex Bit Socket</p> <p>T20 - T25 - T27 T30 - T40 T45 - T50 - T55 - T60</p> <p><b>Lokmalı Torx Allen Uç 60mm</b> Torx Bit Socket</p>	17	419,15

1114

1/2" On İki Köşe Lokmalı Bits Uç Yivli  
Hex Bit Socket 12 Points



1/2"



Krom vanadyum, Krom kaplı  
Chrom vanadium, Chrom plated

KOD CODE		L mm	g		TL/Ad.
1114 06 4005	M5	60	60	10	16,10
1114 06 4006	M6	60	62	10	16,10
1114 06 4008	M8	60	62	10	16,10
1114 06 4010	M10	60	78	10	16,10
1114 06 4012	M12	60	84	10	19,15
1114 06 4106	M6	80	69	10	20,35
1114 06 4108	M8	80	70	10	20,35
1114 06 4110	M10	80	84	10	22,45
1114 06 4112	M12	80	103	10	23,20
1114 06 4114	M14	80	133	10	24,85
1114 06 4208	M8	140	96	10	22,85
1114 06 4210	M10	140	125	10	28,00
1114 06 4212	M12	140	161	10	31,60
1114 06 4214	M14	140	210	10	35,45
1114 06 4216	M16	140	281	10	51,45

1114

1/2" Lokmalı (Ribe) Bits Uç  
Socket Wrench 6 Points



1/2"



Krom vanadyum, Krom kaplı  
Chrom vanadium, Chrom plated

KOD CODE		L mm	g		TL/Ad.
1114 06 5004	4	100	75	10	22,00
1114 06 5005	5	100	76	10	22,00
1114 06 5006	6	100	76	10	22,00
1114 06 5007	7	100	77	10	22,00
1114 06 5008	8	100	78	10	22,00
1114 06 5009	9	100	85	10	22,20
1114 06 5010	10	100	96	10	22,20
1114 06 5011	10.5	100	96	10	22,70
1114 06 5012	12	100	121	10	28,30
1114 06 5013	13	100	148	10	31,05
1114 06 5014	14	100	150	10	31,05
1114 06 5016	16	100	198	10	42,05



Havali aletler ile kullanmayınız / Do not use with power-tools



1513

1/2" Cırcır Kolu (32 Diş)  
Ratchet Handle



TS ISO 3315  
DIN3122



1/2"

Krom vanadyum, Krom kaplı  
Chrom vanadium, Chrom plated

KOD CODE	L mm	g		TL/Ad.
1513 06 0032	250	580	5	122,85

1513

1/2" Cırcır Kolu (72 Diş)  
Max Gear Ratchet Handle

TS ISO 3315



1/2"

Krom vanadyum, Krom kaplı  
Chrom vanadium, Chrom plated

KOD CODE	L mm	g		TL/Ad.
1513 06 0072	250	460	5	217,50

1513

1/2" Ara Kol  
Extension Bar

TS ISO 1174  
DIN 3123



1/2"

Krom vanadyum, Krom kaplı  
Chrom vanadium, Chrom plated

KOD CODE	L mm	g		TL/Ad.
1513 06 4075	75	140	5	24,30
1513 06 4125	125	215	5	29,60
1513 06 4250	250	420	5	49,70

1513

1/2" T Kol Adaptörü  
Adapter



1/2"

Krom vanadyum, Krom kaplı  
Chrom vanadium, Chrom plated

KOD CODE	L mm	g		TL/Ad.
1513 06 5250	40	90	5	23,00

1513

1/2" T Kol  
Sliding T - Handle

TS ISO 3315  
DIN 3122



1/2"

Krom vanadyum, Krom kaplı  
Chrom vanadium, Chrom plated

KOD CODE	L mm	g		TL/Ad.
1513 06 2250	250	355	5	54,10

1513

1/2" Mafsal  
Universal Joint

TS ISO 1174  
DIN 3123



1/2"

Krom vanadyum, Krom kaplı  
Chrom vanadium, Chrom plated

KOD CODE	L mm	g		TL/Ad.
1513 06 4070	70	140	5	48,40

1513

1/2" Lokma Adaptörü  
Adapter

TS ISO 1174  
DIN 3123



1/2"

Krom vanadyum, Krom kaplı  
Chrom vanadium, Chrom plated

KOD CODE	inch	g		TL/Ad.
1513 06 0002	1/2"Fx3/8"M	55	5	15,50
1513 06 0003	1/2"Fx3/4"M	115	5	24,50

1113

1/2" Altı Köşe Lokma Anahtar Takımı (17 Parça, mm)  
Socket Wrench Set 6 Points (17 pcs, mm)

3



1/2"



KOD CODE	LOKMALAR Sockets	AVADANLIKLAR Accessories	g	TL/Ad.
1113 00 2017	10 - 11 - 12 13 - 14 - 15 17 - 19 - 22 24 - 27 - 30 32	<b>1/2" Cırcır Kolu</b> Ratchet Handle <b>1/2" T Kol Adaptör</b> Sliding T Handle Adapter <b>1/2" Mafsalsal</b> Universal Joint <b>1/2" Ara Kol</b> Extension Bar 250 mm	2880 17	473,25

1113

1/2" Altı Köşe Lokma Anahtar Takımı (24 Parça, mm)  
Socket Wrench Set 6 Points (24 pcs, mm)



1/2"



KOD CODE	LOKMALAR Sockets	AVADANLIKLAR Accessories	g	TL/Ad.
1113 00 2024	10 - 11 - 12 13 - 14 - 15 16 - 17 - 18 19 - 21 - 22 23 - 24 - 26 27 - 28 - 30 32	<b>1/2" Cırcır Kolu</b> Ratchet Handle <b>1/2" Mafsalsal</b> Universal Joint <b>1/2" T Kol Adaptör</b> Sliding T Handle Adapter <b>1/2" Ara Kol</b> Extension Bar 125 mm <b>1/2" Ara Kol</b> Extension Bar 250 mm	3650 24	611,60

1114

1/2" On İki Köşe Lokma Anahtar Takımı (24 Parça, mm)  
Socket Wrench Set 12 Points (24 pcs, mm)



1/2"



KOD CODE	LOKMALAR Sockets	AVADANLIKLAR Accessories	g	TL/Ad.
1114 00 6024	10 - 11 - 12 13 - 14 - 15 16 - 17 - 18 19 - 21 - 22 23 - 24 - 26 27 - 28 - 30 32	<b>1/2" Cırcır Kolu</b> Ratchet Handle <b>1/2" Mafsalsal</b> Universal Joint <b>1/2" T Kol Adaptör</b> Sliding T Handle Adapter <b>1/2" Ara Kol</b> Extension Bar 125 mm <b>1/2" Ara Kol</b> Extension Bar 250 mm	4150 24	635,05

1413

1/2" On İki Köşe Lokma Anahtar Takımı (24 parça, SAE)  
Socket Wrench Set 12 Points (24 pcs, SAE)



1/2"



KOD CODE	LOKMALAR Sockets	AVADANLIKLAR Accessories	g	TL/Ad.
1413 00 6024	5/16" - 3/8" 7/16" - 15/32" 1/2" - 9/16" 19/32" - 5/8" 11/16" - 3/4" 25/32" - 13/16" 7/8" - 15/16" 1" - 1 1/16" 1 1/8" - 1 3/16" 1 1/4"	<b>1/2" Cırcır Kolu</b> Ratchet Handle <b>1/2" Mafsalsal</b> Universal Joint <b>1/2" T Kol Adaptör</b> Sliding T Handle Adapter <b>1/2" Ara Kol</b> Extension Bar 125 mm <b>1/2" Ara Kol</b> Extension Bar 250 mm	4150 24	678,20

**1119**

**3/4" Altı Köşe Lokma Anahtar (mm)**  
Socket Wrench 6 Points (mm)

TS ISO 2725 -1  
DIN 3124

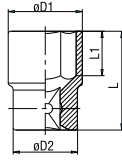

**3/4"**

Krom vanadyum, Krom kaplı  
Chrom vanadium, Chrom plated

KOD CODE	Ø mm	Ø D1 mm	Ø D2 mm	L mm	L1 mm	g	TL/Ad.
1119 06 1022	22	33	36	52	16	225	5 35,35
1119 06 1024	24	35	36	52	16	230	5 35,35
1119 06 1027	27	38	36	52	19	235	5 36,50
1119 06 1030	30	42	38	54	21	300	5 39,30
1119 06 1032	32	44	38	56	23	320	5 40,90
1119 06 1034	34	47	42	58	24	400	5 53,95
1119 06 1036	36	50	42	58	25	440	5 53,95
1119 06 1038	38	52	45	60	27	500	5 53,95
1119 06 1041	41	56	45	64	29	580	1 79,45
1119 06 1046	46	62	48	68	33	730	1 84,50
1119 06 1050	50	68	48	72	34	885	1 101,55
1119 06 1055	55	76	48	76	37	1070	1 129,25
1119 06 1060	60	80	48	78	38	1170	1 154,45

**1419**

**3/4" On İki Köşe Lokma Anahtar (SAE)**  
Socket Wrench 12 Points (SAE)

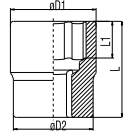

**3/4"**

Krom vanadyum, Krom kaplı  
Chrom vanadium, Chrom plated

KOD CODE	Ø inch	Ø D1 mm	Ø D2 mm	L mm	L1 mm	g	TL/Ad.
1419 06 1022	7/8"	33	36	52	16	220	5 44,10
1419 06 1024	15/16"	35	36	52	16	220	5 44,10
1419 06 1025	1"	35	36	52	17	220	5 44,25
1419 06 1027	1 1/16"	38	36	52	19	225	5 45,40
1419 06 1028	1 1/8"	40	38	52	19	225	5 45,40
1419 06 1032	1 1/4"	44	38	56	23	315	5 51,00
1419 06 1033	1 5/16"	46	38	56	23	355	5 63,40
1419 06 1035	1 3/8"	48	42	58	25	400	5 63,40
1419 06 1036	1 7/16"	50	42	58	25	425	5 66,50
1419 06 1038	1 1/2"	52	45	60	27	475	5 66,50
1419 06 1041	1 5/8"	56	45	64	29	555	1 98,55
1419 06 1044	1 3/4"	60	47	66	31	660	1 104,05
1419 06 1046	1 13/16"	62	47	68	34	685	1 104,75
1419 06 1047	1 7/8"	64	48	70	34	730	1 125,65
1419 06 1050	2"	68	48	72	34	805	1 126,55

**1120**

**3/4" On İki Köşe Lokma Anahtar (mm)**  
Socket Wrench 12 Points (mm)

TS ISO 2725 -1  
DIN 3124

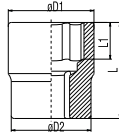

**3/4"**

Krom vanadyum, Krom kaplı  
Chrom vanadium, Chrom plated

KOD CODE	Ø mm	Ø D1 mm	Ø D2 mm	L mm	L1 mm	g	TL/Ad.
1120 06 1022	22	33	36	52	16	220	5 35,55
1120 06 1024	24	35	36	52	17	225	5 35,55
1120 06 1027	27	38	36	52	19	225	5 36,65
1120 06 1030	30	42	38	54	21	285	5 39,50
1120 06 1032	32	44	38	56	23	310	5 41,30
1120 06 1034	34	47	42	57	24	385	5 54,40
1120 06 1036	36	50	42	58	25	435	5 54,40
1120 06 1041	41	56	45	64	29	560	1 80,30
1120 06 1046	46	62	47	68	34	685	1 85,40
1120 06 1050	50	68	48	72	34	840	1 102,20

**1519**

**3/4" Cırcır Kolu**  
Ratchet Handle

TS ISO 3315  
DIN 3122



**3/4"**

Krom vanadyum, Krom kaplı  
Chrom vanadium, Chrom plated

KOD CODE	L mm	g	TL/Ad.
1519 06 4510	510	2230	5 344,30

**1519**

**3/4" Ara Kol**  
Extension Bar

TS ISO 1174  
DIN 3123



**3/4"**

Krom vanadyum, Krom kaplı  
Chrom vanadium, Chrom plated

KOD CODE	L mm	g	TL/Ad.
1519 06 4200	200	730	5 101,05
1519 06 4400	400	1370	5 183,20

1519

3/4" T Kol  
Sliding T - Handle

TS ISO 3315  
DIN 3122



3/4"

Krom vanadyum, Krom kaplı  
Chrom vanadium, Chrom plated

KOD CODE	L mm	g	TL/Ad.
1519 06 4500	500	1485	203,80

1519

3/4" Lokma Adaptörü  
Adapter

TS ISO 1174  
DIN 3123



3/4"

Krom vanadyum, Krom kaplı  
Chrom vanadium, Chrom plated

KOD CODE	inch	g	TL/Ad.
1519 06 0008	3/4"Fx1/2"M	140	39,35
1519 06 0001	3/4"Fx1"M	300	53,25

1119

3/4" Altı Köşe Lokma Anahtar Takımı (14 parça, mm)  
Socket Wrench Set 6 Points (14 pcs, mm)



3/4"

KOD CODE	LOKMALAR Sockets	AVADANLIKLAR Accessories	g	TL/Ad.
1119 00 6114	22 - 24 - 27 30 - 32 - 34 36 - 41 - 46 50	3/4" Cırcır Kolu Ratchet Handle	10180	14
		3/4" T Kol Sliding T Handle		
		3/4" Ara Kol Extension Bar 200 mm		
		3/4" Ara Kol Extension Bar 400 mm		
		1393,15		

1120

3/4" On İki Köşe Lokma Anahtar Takımı (14 parça, mm)  
Socket Wrench Set 12 Points (14 pcs, mm)



3/4"

KOD CODE	LOKMALAR Sockets	AVADANLIKLAR Accessories	g	TL/Ad.
1120 00 6014	22 - 24 - 27 30 - 32 - 34 36 - 41 - 46 50	3/4" Cırcır Kolu Ratchet Handle	13700	14
		3/4" T Kol Sliding T Handle		
		3/4" Ara Kol Extension Bar 200 mm		
		3/4" Ara Kol Extension Bar 400 mm		
		1397,60		

1419

3/4" On İki Köşe Lokma Takımı (14 parça, SAE)  
Socket Wrench Set 12 Points (14 pcs, SAE)



3/4"

KOD CODE	LOKMALAR Sockets	AVADANLIKLAR Accessories	g	TL/Ad.
1419 00 6114	15/16" - 1 1/6" 1 1/8" - 1 1/4" 1 5/16" 1 3/8" 1 1/2" - 1 5/8" 1 7/8" - 2"	3/4" Cırcır Kolu Ratchet Handle	10180	14
		3/4" T Kol Sliding T Handle		
		3/4" Ara Kol Extension Bar 200 mm		
		3/4" Ara Kol Extension Bar 400 mm		
		1558,80		

## 1225

1" On İki Köşe Lokma Anahtar (mm)  
Socket Wrench 12 Points (mm)

DIN 3124

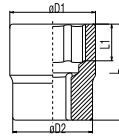

1"

Krom vanadyum, Krom kaplı  
Chrom vanadium, Chrom plated

KOD CODE	mm	Ø D1 mm	Ø D2 mm	L mm	L1 mm	g	TL/Ad.
1225 06 0036	36	52	48	65	26	525	77,10
1225 06 0041	41	58	50	70	29	665	84,00
1225 06 0046	46	65	54	75	32	900	101,85
1225 06 0050	50	70	57	75	34	1040	120,65
1225 06 0055	55	76	57	83	42	1250	155,05
1225 06 0060	60	82	60	87	46	1505	200,85

## 1525

1" Lokma Adaptörü  
Adapter

TS ISO 1174  
DIN 3123

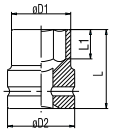

1"

Krom vanadyum, Krom kaplı  
Chrom vanadium, Chrom plated

KOD CODE	inch	g	TL/Ad.
1525 06 0005	1"Fx3/4"M	330	5 69,65

## 1113

1/2" Alaşımli Jant Lokma Takımı (3 Parca, mm)  
Combination Lug Nut Socket Set (3 Pcs, mm)



1/2"

KOD CODE	LOKMA LAR Sockets	g	TL/Ad.
1113 00 9003	17-19-21	800	3 216,00

## 1113

1/2" Altı Köşe Havalı Lokma Anahtar (mm)  
Impact Socket Wrench 6 Points (mm)



1/2"

Krom molibden, Fosfat kaplamalı  
Chrom molybdenum, Phosphate finish

KOD CODE	mm	Ø D1 mm	Ø D2 mm	L mm	L1 mm	g	TL/Ad.
1113 06 7010	10	17	25	38	8	70	17,20
1113 06 7011	11	18	25	38	8	70	17,20
1113 06 7012	12	19	25	38	9	70	17,20
1113 06 7013	13	20	25	38	10	70	18,45
1113 06 7014	14	22	25	38	10	75	18,45
1113 06 7015	15	23	30	38	11	110	18,45
1113 06 7016	16	24	30	38	11	110	19,30
1113 06 7017	17	26	30	38	12	115	19,35
1113 06 7018	18	27	30	38	13	115	19,40
1113 06 7019	19	28	30	38	13	120	19,80
1113 06 7021	21	30	30	40	14	125	20,15
1113 06 7022	22	32	30	40	14	145	20,15
1113 06 7024	24	34	30	42	15	150	23,15
1113 06 7027	27	38	30	44	16	175	33,70

Havalı aletler ile kullanmayınız / Do not use with power-tools

1108

1/2" Altı Köşe Havalı Derin Lokma Anahtar (mm)  
6 Point Impact Socket Wrench, Long Type (mm)

YENİ  
NEW

3



1/2"

Krom molibden, Fosfat kaplamalı  
Chrom molybdenum, Phosphate finish

KOD CODE	mm	L mm	g	TL/Ad.
1108 06 7010	10	80	136	10 29,15
1108 06 7011	11	80	144	10 29,15
1108 06 7012	12	80	157	10 29,15
1108 06 7013	13	80	157	10 29,15
1108 06 7014	14	80	172	10 29,15
1108 06 7015	15	80	223	10 35,35
1108 06 7016	16	80	230	10 35,35
1108 06 7017	17	80	240	10 35,35
1108 06 7018	18	80	255	10 35,35
1108 06 7019	19	80	236	10 35,35
1108 06 7021	21	80	240	10 36,85
1108 06 7022	22	80	296	5 36,85
1108 06 7024	24	80	308	5 38,95
1108 06 7027	27	80	356	5 51,60
1108 06 7030	30	80	416	5 57,80
1108 06 7032	32	80	510	5 61,65

1513

1/2" Havalı Lokma Adaptörü  
Impact Socket Adapter



1/2"

Krom molibden, Fosfat kaplamalı  
Chrom molybdenum, Phosphate finish

KOD CODE	inch	g	TL/Ad.
1513 06 7002	1/2"Fx3/8"M	95	5 39,60
1513 06 7003	1/2"Fx3/4"M	175	5 45,20

1513

1/2" Havalı Lokma Mafsalı  
Impact Socket Universal Joint



1/2"

Krom molibden, Fosfat kaplamalı  
Chrom molybdenum, Phosphate finish

KOD CODE	L mm	g	TL/Ad.
1513 06 7075	75	220	5 76,10

1513

1/2" Havalı Lokma Ara Kol  
Impact Socket Extension Bar



1/2"

Krom molibden, Fosfat kaplamalı  
Chrom molybdenum, Phosphate finish

KOD CODE	L mm	g	TL/Ad.
1513 06 7125	125	275	5 59,90



1119

3/4" Altı Köşe Havalı Lokma Anahtar (mm)  
Impact Socket Wrench 6 Points (mm)



3/4"

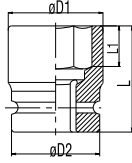

Krom molibden, Fosfat kaplamalı  
Chrom molybdenum, Phosphate finish

KOD CODE	mm	Ø D1 mm	Ø D2 mm	L mm	L1 mm	g	TL/Ad.
1119 06 7019	19	32	44	50	13	330	5 49,30
1119 06 7021	21	35	44	50	15	340	5 49,30
1119 06 7022	22	36	44	50	15	345	5 49,30
1119 06 7024	24	38	44	50	16	350	5 49,30
1119 06 7027	27	42	44	53	17	380	5 50,75
1119 06 7030	30	46	44	53	20	410	1 54,65
1119 06 7032	32	48	44	57	20	460	1 54,65
1119 06 7034	34	51	44	57	22	490	1 71,35
1119 06 7036	36	53	44	57	22	520	1 71,35
1119 06 7041	41	59	44	58	24	580	1 110,10
1119 06 7046	46	66	44	62	24	715	1 117,05

1519

3/4" Havalı Lokma Ara Kol  
Impact Socket Extension Bar



3/4"

Krom molibden, Fosfat kaplamalı  
Chrom molybdenum, Phosphate finish

KOD CODE	L mm	g	TL/Ad.
1519 06 7175	175	865	5 143,90
1519 06 7250	250	1155	5 205,80
1519 06 7330	330	1425	5 312,35

1519

3/4" Havalı Lokma Mafsal  
Impact Socket Universal Joint



3/4"

Krom molibden, Fosfat kaplamalı  
Chrom molybdenum, Phosphate finish

KOD CODE	L mm	g	TL/Ad.
1519 06 7108	108	735	5 239,70

1519

3/4" Havalı Lokma Adaptörü  
Impact Socket Adapter



3/4"

Krom molibden, Fosfat kaplamalı  
Chrom molybdenum, Phosphate finish

KOD CODE	inch	g	TL/Ad.
1519 06 7011	3/4"Fx1/2" M	315	5 70,20



1125

1" Altı Köşe Havalı Lokma Anahtar (mm)  
Impact Socket Wrench 6 Points (mm)



1"

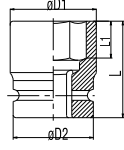

Krom molibden, Fosfat kaplamalı  
Chrom molybdenum, Phosphate finish

KOD CODE	mm	Ø D1 mm	Ø D2 mm	L mm	L1 mm	g	TL/Ad.
1125 06 7024	24	41	54	58	17	560	1 84,85
1125 06 7027	27	44	54	58	19	565	1 85,65
1125 06 7030	30	48	54	60	21	605	1 86,30
1125 06 7032	32	51	54	62	21	650	1 87,35
1125 06 7033	33	52	54	62	21	660	1 87,35
1125 06 7034	34	53	54	62	24	765	1 87,80
1125 06 7036	36	56	54	65	24	720	1 88,25
1125 06 7038	38	58	54	65	26	735	1 91,90
1125 06 7041	41	61	54	70	28	845	1 98,55
1125 06 7046	46	68	54	75	30	1075	1 113,30
1125 06 7050	50	73	54	75	32	1170	1 126,05
1125 06 7055	55	79	54	83	37	1435	1 174,75
1125 06 7060	60	86	54	87	37	1760	1 218,45

1525

1" Havalı Lokma Mafsal  
Impact Socket Universal Joint



1"

Krom molibden, Fosfat kaplamalı  
Chrom molybdenum, Phosphate finish

KOD CODE	L mm	g	TL/Ad.
1525 06 7128	128	1530	1 468,30

1525

1" Havalı Lokma Ara Kol  
Impact Socket Extension Bar



1"

Krom molibden, Fosfat kaplamalı  
Chrom molybdenum, Phosphate finish

KOD CODE	L mm	g	TL/Ad.
1525 06 7175	175	1395	5 250,55
1525 06 7250	250	1890	5 322,20
1525 06 7330	330	2455	5 391,20

1525

1" Havalı Lokma Adaptörü  
Impact Socket Adapter



1"

Krom molibden, Fosfat kaplamalı  
Chrom molybdenum, Phosphate finish

KOD CODE	inch	g	TL/Ad.
1525 06 7015	1"Fx3/4"M	560	5 110,40

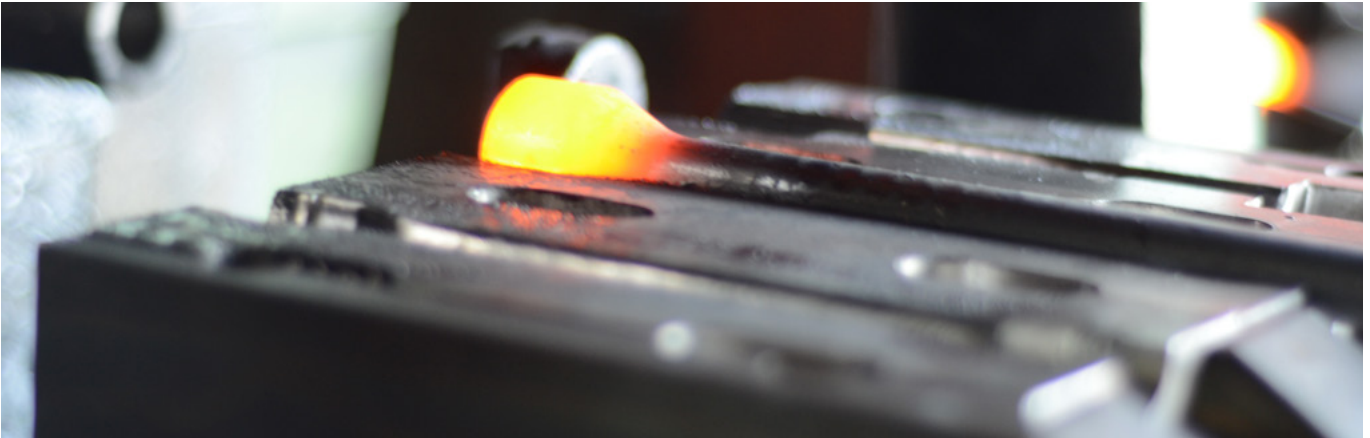



## 1800

### Kovan Anahtar İki Ağz (mm) Double Ended Tubular Socket Wrench (mm)

TS ISO 3793  
DIN 896  
TSE



Dikişsiz çelik boru, Çinko kaplı  
Seamless steel tube, Zinc plated

KOD CODE	mm	L mm	AA1 mm	AA2 mm	H1 mm	H2 mm	g	TL/Ad.	
1800 07 0607	6x7	105	8.6	9.6	7	8	25	5	16,75
1800 07 0809	8x9	105	11.2	12.2	9	10	35	5	18,40
1800 07 1011	10x11	120	13.6	14.6	11	11.5	55	5	25,30
1800 07 1213	12x13	135	16	17	12	12.5	80	5	26,80
1800 07 1415	14x15	135	18.5	19.5	13	13.5	110	5	29,45
1800 07 1617	16x17	150	21	22	14	14.5	150	5	31,60
1800 07 1819	18x19	150	23	24	15	15.5	170	5	32,75
1800 07 2022	20x22	165	25.4	27.4	16	18	220	5	36,10
1800 07 2224	22x24	180	27.4	29.4	18	20	330	5	40,50
1800 07 2427	24x27	180	30.4	33.4	20	23	400	5	52,45

## 1800

### Kovan Anahtar Takımı İki Ağz (mil dahil, mm) Double Ended Tubular Socket Wrench Set with Tommy Bars (mm)

TSE

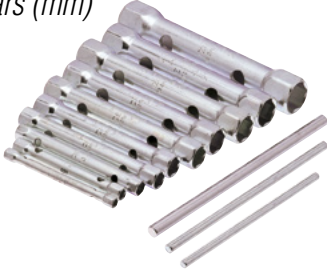

KOD CODE	mm	g	TL/Ad.	
1800 00 2108	6x7 - 8x9 - 10x11 12x13 - 14x15 - 16x17 18x19 - 20x22 Mil/Handle Bars 5x125-8x180 mm	920	8	234,65

## 1841

### Kovan Anahtar Bir Ağz (mil dahil) Single Ended Tubular Socket Wrench with Tommy Bar

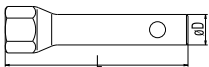

Dikişsiz çelik boru, Çinko kaplı  
Seamless steel tube, Zinc plated

KOD CODE	mm		L mm	σD mm	Mil Handle bar mm	g	TL/Ad.	
	mm	inch						
1841 07 0021	21	13/16"	120	20	10x120	215	5	28,35

## 1850

### Kovan Anahtar Mili Tommy Bar

TS ISO 3793  
DIN 900

KOD CODE	σDxL mm	g	TL/Ad.	
1850 07 5125	5x125	20	10	6,90
1850 07 8180	8x180	70	10	10,60
1850 07 1120	10x120	75	10	12,00
1850 07 1200	10x200	120	10	13,55

## 1870

### Ağır Tip Bijon Anahtarı İki Ağz Uzun Double Ended Rim Wrench (long)

TSEK



Yüksek alaşımlı çelik, Nikel kaplı  
Special steel, Nickel plated

KOD CODE	mm	L mm	t mm	σD1 mm	σD2 mm	g	TL/Ad.	
1870 09 2427	24x27	400	34.5	36	40	1135	10	78,65
1870 09 2730	27x30	400	34.5	40	44	1380	10	90,30
1870 09 2732	27x32	400	34.5	40	46	1380	10	90,30
1870 09 3032	30x32	400	34.5	44	46	1380	10	93,50
1870 09 3233	32x33	400	34.5	46	47	1450	10	103,75

## 1874

### Ağır Tip Bijon Anahtarı İki Ağz Kısa Double Ended Rim Wrench (short)

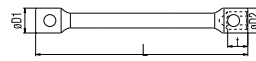

Yüksek alaşımlı çelik, Nikel kaplı  
Special steel, Nickel plated

KOD CODE	mm	L mm	t mm	σD1 mm	σD2 mm	g	TL/Ad.	
1874 09 2224	22x24	170	34.5	34	36	720	10	49,80
1874 09 2427	24x27	200	34.5	36	40	800	10	63,70

## 1850

### Bijon Anahtar Mili Tommy Bar

TS ISO 3793  
DIN 900

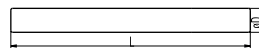

KOD CODE	σDxL mm	g	TL/Ad.	
1850 09 1630	18x630	1260	1	45,75

1975

Bijon Anahtarı İstavroz Tipi  
Cross Rim Wrench

TS ISO 6788

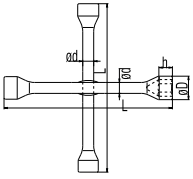
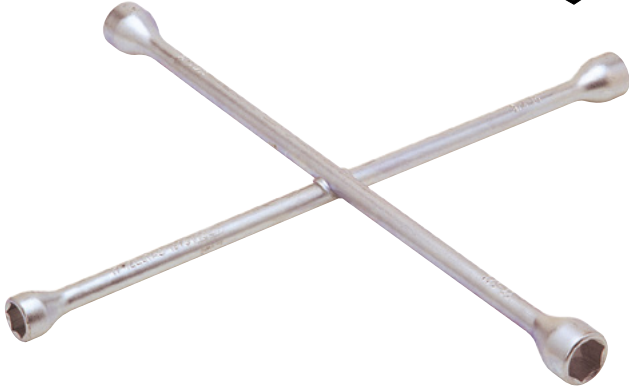

Yüksek alaşımlı çelik, Krom kaplı  
Special steel, Chrom plated

KOD CODE	mm	inch	øD mm	h mm	L mm	ød mm	g	TL/Ad.
1975 09 1719	17	11/16"	28	12	420	16	1422	10
	19	3/4"	30	14				
	21	13/16"	32	16				
	22	7/8"	34	17				

1975

1/2" Adaptörlü Bijon Anahtarı İstavroz Tipi  
Cross Rim Wrench (with 1/2" adapter)

TS ISO 6788

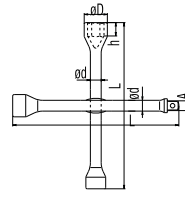

Yüksek alaşımlı çelik, Krom kaplı  
Special steel, Chrom plated

KOD CODE	mm	inch	øD mm	h mm	L mm	A mm	ød mm	g	TL/Ad.
1975 09 1322	17	11/16"	28	12	420	12.65	16	1375	10
	19	3/4"	30	14					
	22	7/8"	34	17					
		1/2"							

1940

Bijon Anahtarı Pipo Tipi (Tornavida Ağızlı)  
Offset Socket Wrench with Screwdriver

TSEK

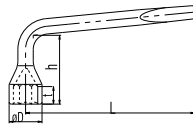

Yüksek alaşımlı çelik, Krom kaplı  
Special steel, Chrom plated

KOD CODE	mm	inch	L mm	øD mm	h mm	t mm	g	TL/Ad.
1940 09 0019	19	3/4"	285	28	65	14	470	10
1940 09 0021	21	13/16"	320	30	85	16	575	10



1855

Mafsallı T Kol Lokma  
T - Handle Wrench with Universal Joint



1840

1/2" Mafsallı T Kol  
Swivel Handle With Sliding T 1/2"



3

Özel alaşım çelik, Krom kaplı  
Special steel, Chrom plated

Özel alaşım çelik, Krom kaplı  
Special steel, Chrom plated

KOD CODE	mm	L mm	g	TL/Ad.	
1855 08 0008	8	400	225	10	141,40
1855 08 0010	10	450	405	10	177,85
1855 08 0012	12	450	410	10	177,85
1855 08 0013	13	450	425	10	177,85
1855 08 0017	17	500	485	10	198,10
1855 08 0019	19	510	895	10	251,80

KOD CODE	mm	L mm	g	TL/Ad.	
1840 08 0500	1/2"	500	740	10	160,00



**1610**

3/8" Tork Anahtarı  
Torque Wrench

TS EN ISO 6789-1  
TS EN ISO 6789-2



**3/8"**

KOD CODE	ÖLÇÜ SIZE	g		TL/Ad.
1610 06 0100	2.5 - 11 Nm - 0.3 - 1.2 Kg	515	1	851,20
1610 06 0300	5 - 33 Nm - 0.5 - 3.4 Kg	640	1	880,00

**1613**

1/2" Tork Anahtarı  
Torque Wrench

TS EN ISO 6789-1  
TS EN ISO 6789-2



**1/2"**

KOD CODE	ÖLÇÜ SIZE	g		TL/Ad.
1613 06 1200	25 - 135 Nm - 3 - 14 Kg	1430	1	908,80
1613 06 2000	50 - 225 Nm - 5 - 23 Kg	2165	1	938,05
1613 06 3000	70 - 330 Nm - 7 - 35 Kg	2870	1	1141,45

**1619**

3/4" Tork Anahtarı  
Torque Wrench

TS EN ISO 6789-1  
TS EN ISO 6789-2



**3/4"**

KOD CODE	ÖLÇÜ SIZE	g		TL/Ad.
1619 06 2080	200 - 800 Nm-22-82 kg	8860	1	3517,75

**1607**

1/4" Cıvırlı Tork Anahtar  
Torque Wrench  
With Reversible Ratchet-Head

TS EN ISO 6789-1  
TS EN ISO 6789-2



**1/4"**

KOD CODE	ÖLÇÜ SIZE	g		TL/Ad.
1607 06 0420	4 - 20 Nm	640	1	673,75

**1610**

3/8" Cıvırlı Tork Anahtar  
Torque Wrench With Reversible Ratchet-Head

TS EN ISO 6789-1  
TS EN ISO 6789-2



**3/8"**

KOD CODE	ÖLÇÜ SIZE	g		TL/Ad.
1610 06 2010	20 -100 Nm	1300	1	760,70

**1613**

1/2" Cıvırlı Tork Anahtar  
Torque Wrench  
With Reversible Ratchet-Head

TS EN ISO 6789-1  
TS EN ISO 6789-2



**1/2"**

KOD CODE	ÖLÇÜ SIZE	g		TL/Ad.
1613 06 4020	40- 200Nm	1590	1	779,70
1613 06 6034	60- 340Nm	1810	1	817,45

**1619**

3/4" Cıvırlı Tork Anahtar  
Torque Wrench  
With Reversible Ratchet-Head

TS EN ISO 6789-1  
TS EN ISO 6789-2



**3/4"**

KOD CODE	ÖLÇÜ SIZE	Dış Sayısı Gear Teeth	L mm	g		TL/Ad.
1619 06 1060	100-600 Nm	24	1048	5600	1	2358,70

# 4

## Boru Anahtarları ve Penseler Pipe Wrenches and Pliers



- Boru Anahtarları* Pipe Wrenches
- Fort Penseler* Water Pump Pliers
- Ayarlı Penseler* Grip Wrenches
- Penseler* Pliers
- Uzun Kargaburunlar* Long Nose Pliers
- Kerpetenler* Carpenter Pincers
- Elektronikçi Penseler* Electronic Pliers

2100

Stilson Boru Anahtarı  
Pipe Wrench, Stilson



TS 3796



4

Yedek parça sayfa 164  
Spare parts page 164

Krom vanadyum, Dişler indüksiyonda sertleştirilmiş, Elektrostatik boyanmış  
Chrom vanadium, Teeth induction hardened, Electrostatically painted

KOD CODE	L mm	L inch	mm	ÖLÇÜ SIZE Inch	g		TL/Ad.
2100 10 0008	200	8"	27	3/4"	280	1	91,00
2100 10 0010	250	10"	34	1"	550	1	117,25
2100 10 0012	300	12"	42	1 1/4"	725	1	131,95
2100 10 0014	350	14"	50	1 1/2"	1030	1	151,20
2100 10 0018	450	18"	60	2"	1775	1	205,65
2100 10 0024	600	24"	76	2 1/2"	2775	1	331,35

2110

Ağır Tip Boru Anahtarı  
Pipe Wrench, Heavy Duty



Yedek parça sayfa 164  
Spare parts page 164

Krom vanadyum, Dişler indüksiyonda sertleştirilmiş, Elektrostatik boyanmış  
Chrom vanadium, Teeth induction hardened, Electrostatically painted

KOD CODE	L mm	L inch	mm	ÖLÇÜ SIZE Inch	g		TL/Ad.
2110 10 0008	200	8"	34	1"	425	1	109,95
2110 10 0010	250	10"	42	1 1/4"	795	1	143,55
2110 10 0012	300	12"	50	1 1/2"	1245	1	167,30
2110 10 0014	350	14"	60	2"	1710	1	191,65
2110 10 0018	450	18"	75	2 1/2"	2685	1	271,70
2110 10 0024	600	24"	90	3"	4370	1	430,50
2110 10 0036	900	36"	140	5"	7600	1	970,90
2110 10 0048	1200	48"	165	6"	15600	1	1801,10

2201

Maşalı Boru Anahtarı (85°)  
Pipe Wrench (85°)



TS 3796  
DIN 5234



Yedek parça sayfa 164  
Spare parts page 164

Krom vanadyum, Dişler indüksiyonda sertleştirilmiş, Elektrostatik boyanmış  
Chrom vanadium, Teeth induction hardened, Electrostatically painted

KOD CODE	L mm	mm	ÖLÇÜ SIZE Inch	g		TL/Ad.
2201 10 0010	325	40	1"	870	1	104,60
2201 10 0015	430	60	1 1/2"	1585	1	162,10
2201 10 0020	585	70	2"	2700	1	242,80
2201 10 0030	690	100	3"	4270	1	368,10
2201 10 0040	760	130	4"	5800	1	552,10

2400

Üniversal Fort Pense  
Waterpump Pliers Universal



TS 60 TS ISO 8976  
DIN ISO 8976



Krom vanadyum, Krom kaplı, PVC izoleli  
Chrom vanadium, Chrom plated, PVC insulated

KOD CODE	L mm	L inch	mm	g		TL/Ad.
2400 11 0160	160	6 1/4"	30	125	5	63,50
2400 11 0240	240	9 1/2"	35	355	5	81,40
2400 11 0315	315	12 1/2"	40	530	5	145,55

2400

1000V İzoleli Üniversal Fort Pense  
Insulated Type Waterpump  
Pliers Universal 1000V



TS 60  
TS ISO 8976



Krom vanadyum, Krom kaplı, çift komponent saplı  
Chrom vanadium, Chrom plated, Two component handle

KOD CODE	L mm	L inch	mm	g	TL/Ad.
2400 11 6240	240	9 1/2"	35	370	5 94,50

2500

Üniversal Ayarlı Pense  
Universal Grip



Çeneler krom vanadyum çeliğinden dövülmüştür, Nikel kaplama,  
Kullanım sahası: Yuvarlak ve düz malzemeler  
Jaws Chrom vanadium forged, Nickel plated  
Application field : Flat and round materials

KOD CODE	L mm	L inch	mm	g	TL/Ad.
2500 11 0250	250	10"	30	560	5 99,65

2415

Yaylı Fort Pense  
Waterpump Pliers With Spring



Krom vanadyum, Karartma, PVC izoleli  
Chrom vanadium, Black finish, PVC insulated

KOD CODE	L mm	L inch	mm	g	TL/Ad.
2415 11 0240	240	6 1/4"	30	365	5 109,90

2505

Standart Ayarlı Pense  
Standard Grip



Çeneler krom vanadyum çeliğinden dövülmüştür, Nikel kaplama  
Kullanım sahası: Düz malzemeler  
Jaws, Chrom vanadium forged, Nickel plated  
Application field: Flat materials

KOD CODE	L mm	L inch	mm	g	TL/Ad.
2505 11 0250	250	10"	30	535	5 99,65

2510

Spesiyal Ayarlı Pense  
Special Grip



4

Çeneler krom vanadyum çeliğinden dövülmüştür, Nikel kaplama,  
Kullanım sahası: Yuvarlak ve düz malzemeler  
Jaws Chrom vanadium forged, Nickel plated  
Application field: Flat and round materials

KOD CODE	L mm	L inch	mm	g	TL/Ad.
2510 11 0250	250	10"	30	550	5 99,65

2511

C tipi Ayarlı Pense  
Clamp Grip C-type



Çeneler krom vanadyum çeliğinden dövülmüştür, Nikel kaplama,  
Kullanım sahası: Ağılı profillerin tutulmasında  
Jaws Chrom vanadium forged, Nickel plated  
Application field: For Gripping angled sheet metal

KOD CODE	L mm	L inch	mm	g	TL/Ad.
2511 11 0280	280	11"	70	700	1 145,85

2512

Kaynakçı Ayarlı Pense (Düz Ağız)  
Lock Grip With Flat Jaws



Özel alaşımli çelikten imal edilmiş, Nikel kaplama,  
Kullanım sahası: 80 mm düz çeneleri ile kıvrık metal levhaları  
Made from special alloy steel, Nickel plated, Application field:  
Gripping sheet metals with 80 mm Flat jaws

KOD CODE	L mm	L inch	mm	g	TL/Ad.
2512 11 0200	200	8"	30	485	1 147,20

2513

Kaynakçı Ayarlı Pense (Boru İçin)  
Grip For Tubes



Özel alaşımli çelikten imal edilmiş, Nikel kaplama,  
Kullanım sahası: Boru malzemeler  
Made from special alloy steel, Nickel plated, Application field: Tubes

KOD CODE	L mm	L inch	mm	g	TL/Ad.
2513 11 0280	280	11"	50	800	1 147,20

2515

Kaportacı Ayarlı Pense  
Welding Grip



Özel alaşımli çelikten imal edilmiş- Nikel kaplama,  
Kullanım sahası: Yassı ve köşeli malzemelerde  
Application field : Angled corners and edges

KOD CODE	L mm	L inch	mm	g	TL/Ad.
2515 11 0270	270	10 5/8"	50	765	1 133,50



3020

**Kombine Pense Opak Seri**  
*Combination Pliers*

TS 60  
TS ISO 5746  
DIN ISO 5746



Özel alaşımli çelik, Kesici ağızlar indüksiyonda sertleştirilmiş  
*Special steel, Cutters induction hardened*

KOD CODE	L mm	L inch	MODEL	g	TL/Ad.
3020 12 2160	160	6 1/4"	OPAK	205	55,15
3020 12 2180	180	7 1/8"	OPAK	275	62,60
3020 12 2200	200	8"	OPAK	315	70,70

3020

**Kombine Pense Kraft Seri**  
*Combination Pliers*

TS 60  
TS ISO 5746  
DIN ISO 5746



Özel alaşımli çelik, Kesici ağızlar indüksiyonda sertleştirilmiş  
*Special steel, Cutters induction hardened*

KOD CODE	L mm	L inch	MODEL	g	TL/Ad.
3020 12 3160	160	6 1/4"	KRAFT	225	67,65
3020 12 3180	180	7 1/8"	KRAFT	285	75,55
3020 12 3200	200	8"	KRAFT	380	85,40

3020

**Kombine Pense Ergonomik Seri**  
*Combination Pliers*

TS 60  
TS ISO 5746  
DIN ISO 5746



Özel alaşımli çelik, Kesici ağızlar indüksiyonda sertleştirilmiş  
*Special steel, Cutters induction hardened*

KOD CODE	L mm	L inch	MODEL	g	TL/Ad.
3020 12 5160	160	6 1/4"	ERGONOMİK	205	69,40
3020 12 5180	180	7 1/8"	ERGONOMİK	260	78,85
3020 12 5200	200	8"	ERGONOMİK	345	89,05

3020

**1000V İzoleli Elektrikçi Kombine Pense**  
*Electrician Type Insulated Combination Plier 1000V*



TS 60  
TS ISO 5746  
DIN ISO 5746



1000 V  
IEC 60900



Özel alaşımli çelik, Kesici ağızlar indüksiyonda sertleştirilmiş, Krom kaplı  
*Special steel, Cutters induction hardened, Chrom plated*

KOD CODE	L mm	L inch	MODEL	g	TL/Ad.
3020 12 6160	160	6 1/4"	1000V	205	76,00
3020 12 6180	180	7 1/8"	1000V	260	81,35
3020 12 6200	200	8"	1000V	345	91,90

3030

**Kombine Pense Ağır Tip (çelik tel için)**  
*Combination Pliers Heavy Duty (for piano wire)*

Özel alaşımli çelik, Kesici ağızlar indüksiyonda sertleştirilmiş  
*Special steel, Cutters induction hardened*

KOD CODE	L mm	L inch	MODEL	g	TL/Ad.
3030 12 2180	180	7 1/8"		285	83,05
3030 12 2200	200	8"		380	95,00

3220

Kargaburun Düz Uçlu Opak Seri  
Long Nose Pliers (Flat)

TS 60 - TS ISO 5745  
DIN ISO 5745



Özel alaşımli çelik, Kesici ağızlar indüksiyonda sertleştirilmiş  
Special steel, Cutters induction hardened

KOD CODE	L mm	L inch	MODEL	g	TL/Ad.
3220 13 2140	140	5 1/2"	OPAK	110	56,95
3220 13 2160	160	6 1/4"	OPAK	135	64,35
3220 13 2180	180	7 1/8"	OPAK	170	70,75
3220 13 2200	200	8"	OPAK	205	75,00

3220

Kargaburun Düz Uçlu Kraft Seri  
Long Nose Pliers (Flat)

TS 60 - TS ISO 5745  
DIN ISO 5745



Özel alaşımli çelik, Kesici ağızlar indüksiyonda sertleştirilmiş  
Special steel, Cutters induction hardened

KOD CODE	L mm	L inch	MODEL	g	TL/Ad.
3220 13 3140	140	5 1/2"	KRAFT	120	70,35
3220 13 3160	160	6 1/4"	KRAFT	155	79,40
3220 13 3180	180	7 1/8"	KRAFT	185	87,35
3220 13 3200	200	8"	KRAFT	210	92,55

3220

Kargaburun Düz Uçlu Ergonomik Seri  
Long Nose Pliers (Flat)

TS 60 - TS ISO 5745  
DIN ISO 5745



Özel alaşımli çelik, Kesici ağızlar indüksiyonda sertleştirilmiş  
Special steel, Cutters induction hardened

KOD CODE	L mm	L inch	MODEL	g	TL/Ad.
3220 13 5140	140	5 1/2"	ERGONOMİK	110	74,00
3220 13 5160	160	6 1/4"	ERGONOMİK	140	83,65
3220 13 5180	180	7 1/8"	ERGONOMİK	160	91,95
3220 13 5200	200	8"	ERGONOMİK	170	97,45

3220

1000V İzoleli Elektrikçi Kargaburun  
Insulated Electrician Type  
Long Nose Plier 1000V



TS 60  
TS ISO 5745  
DIN ISO 5745  
⚡ 1000 V  
IEC 60900



Özel alaşımli çelik, Kesici ağızlar indüksiyonda sertleştirilmiş, Krom kaplı  
Special steel, Cutters induction hardened, Chrom plated

KOD CODE	L mm	L inch	MODEL	g	TL/Ad.
3220 13 6140	140	5 1/2"	1000V	110	81,50
3220 13 6160	160	6 1/4"	1000V	140	90,10
3220 13 6180	180	7 1/8"	1000V	160	101,15
3220 13 6200	200	8"	1000V	170	105,00



3225

Kargaburun Eğri Uçlu Opak Seri  
Long Nose Pliers (Bent)

TS 60 - TS ISO 5745



3225

Kargaburun Eğri Uçlu Kraft Seri  
Long Nose Pliers (Bent)

TS 60 - TS ISO 5745



4

Özel alaşımlı çelik, Kesici ağızlar indüksiyonda sertleştirilmiş  
Special steel, Cutters induction hardened

Özel alaşımlı çelik, Kesici ağızlar indüksiyonda sertleştirilmiş  
Special steel, Cutters induction hardened

KOD CODE	L mm	L inch	MODEL	g	TL/Ad.
3225 13 2160	160	6 1/4"	OPAK	140	68,00
3225 13 2180	180	7 1/8"	OPAK	170	76,85
3225 13 2200	200	8"	OPAK	175	82,10

KOD CODE	L mm	L inch	MODEL	g	TL/Ad.
3225 13 3160	160	6 1/4"	KRAFT	150	81,80
3225 13 3180	180	7 1/8"	KRAFT	190	89,85
3225 13 3200	200	8"	KRAFT	195	98,85



3700

Yan Keski Opak Seri  
Side Cutting Pliers

TS 60 - TS ISO 5749  
DIN ISO 5749



Özel alaşımli çelik, Kesici ağızlar indüksiyonda sertleştirilmiş  
Special steel, Cutters induction hardened

KOD CODE	L mm	L inch	MODEL	g	TL/Ad.
3700 16 2140	140	5 1/2"	OPAK	165	58,35
3700 16 2160	160	6 1/4"	OPAK	230	70,20
3700 16 2180	180	7 1/8"	OPAK	230	81,95

3700

Yan Keski Ergonomik Seri  
Side Cutting Pliers

TS 60 - TS ISO 5749  
DIN ISO 5749



Özel alaşımli çelik, Kesici ağızlar indüksiyonda sertleştirilmiş  
Special steel, Cutters induction hardened

KOD CODE	L mm	L inch	MODEL	g	TL/Ad.
3700 16 5140	140	5 1/2"	ERGONOMİK	165	75,85
3700 16 5160	160	6 1/4"	ERGONOMİK	215	87,75
3700 16 5180	180	7 1/8"	ERGONOMİK	215	102,35

3700

Yan Keski Kraft Seri  
Side Cutting Pliers

TS 60 • DIN ISO 5749  
DIN ISO 5749



Özel alaşımli çelik, Kesici ağızlar indüksiyonda sertleştirilmiş  
Special steel, Cutters induction hardened

KOD CODE	L mm	L inch	MODEL	g	TL/Ad.
3700 16 3140	140	5 1/2"	KRAFT	190	70,40
3700 16 3160	160	6 1/4"	KRAFT	240	84,55
3700 16 3180	180	7 1/8"	KRAFT	255	98,55

3700

1000V İzoleli Elektrikçi Yan Keski  
Insulated Electrician Type Side Cutter 1000V

TS 60  
TS ISO 5749  
DIN ISO 5749

⚡ 1000 V  
IEC 60900



Özel alaşımli çelik, Kesici ağızlar indüksiyonda sertleştirilmiş, Krom kaplı  
Special steel, Cutters induction hardened, Chrom plated

KOD CODE	L mm	L inch	MODEL	g	TL/Ad.
3700 16 6140	140	5 1/2"	1000V	165	84,55
3700 16 6160	160	6 1/4"	1000V	215	95,95
3700 16 6180	180	7 1/8"	1000V	225	107,40

3705

İnce Uçlu Yan Keski (Plastikler İçin)  
Side Cutter For Plastics

TS 60  
TS ISO 5749

3730

Yan Keski Ağır Tip (çelik tel için)  
Side Cutter Heavy Duty (for piano wire)

YENİ  
NEW



4

Özel alaşımlı çelik, Kesici ağızlar induksiyonda sertleştirilmiş, PVC izoleli  
Special steel, Cutters induction hardened, PVC insulated

Özel alaşımlı çelik, Kesici ağızlar induksiyonda sertleştirilmiş  
Special steel, Cutters induction hardened

KOD CODE	L mm	L inch	g	TL/Ad.
3705 16 5160	160	6 1/4"	220	5 83,45

KOD CODE	L mm	L inch	g	TL/Ad.
3730 16 2160	160	6 1/4"	200	5 95,15
3730 16 2200	200	8"	320	5 123,70



3301

Dış Segman Pense (Düz)  
Circlip Pliers, External (Flat)

TS 60  
DIN 5254



Krom vanadyum, Krom kaplı, PVC izoleli  
Chrom vanadium, Chrom plated, PVC insulated

KOD CODE	L mm	⌀	g	□	TL/Ad.
3301 12 0140	140	10 - 25	90	5	64,90
3301 12 0180	180	19 - 60	195	5	68,35
3301 12 0225	225	40 - 100	235	5	85,50
3301 12 0295	295	85 - 165	445	5	145,05

3321

İç Segman Pense (Düz)  
Circlip Pliers Internal (Flat)

TS 60  
DIN 5256



Krom vanadyum, Krom kaplı, PVC izoleli  
Chrom vanadium, Chrom plated, PVC insulated

KOD CODE	L mm	⌀	g	□	TL/Ad.
3321 12 0140	140	8 - 25	100	5	59,70
3321 12 0180	180	19 - 60	185	5	63,00
3321 12 0225	225	40 - 100	250	5	78,50
3321 12 0310	310	85 - 165	445	5	134,70

3311

Dış Segman Pense (Eğri)  
Circlip Pliers, External (Bent)

TS 60  
DIN 5254



Krom vanadyum, Krom kaplı, PVC izoleli  
Chrom vanadium, Chrom plated, PVC insulated

KOD CODE	L mm	⌀	g	□	TL/Ad.
3311 12 0125	125	10 - 25	105	5	72,50
3311 12 0170	170	19 - 60	190	5	76,35
3311 12 0210	210	40 - 100	250	5	87,80
3311 12 0275	275	85 - 165	445	5	152,30

3331

İç Segman Pense (Eğri)  
Circlip Pliers Internal (Bent)

TS 60  
DIN 5256



Krom vanadyum, Krom kaplı, PVC izoleli  
Chrom vanadium, Chrom plated, PVC insulated

KOD CODE	L mm	⌀	g	□	TL/Ad.
3331 12 0130	130	8 - 25	105	5	64,20
3331 12 0170	170	19 - 60	185	5	67,60
3331 12 0210	210	40 - 100	250	5	84,35
3331 12 0290	290	85 - 165	440	5	144,95

**3420**

Hortum Kelepçe Pensesi  
Hose Clamp Pliers



KOD CODE	L mm	L inch	g		TL/Ad.
3420 12 0220	220	8 3/4"	185	5	117,25

**3425**

Hortum Kelepçe Pensesi (Sıkıştırma Tipi)  
Hose Clamp Pliers



KOD CODE	L mm	L inch	g		TL/Ad.
3425 12 0220	235	9 1/4"	355	5	120,10

**3852**

Delik Zimba  
Revolving Punch Pliers



KOD CODE	L mm	L inch	g		TL/Ad.
3852 24 0225	225	9"	270	5	73,00

**3715**

Tek Ağızlı Kablo Kesici  
Cable Cutter



Özel alaşımlı çelik, Kesici ağızlar induksiyonda sertleştirilmiş, PVC izoleli  
Special steel, Cutters induction hardened, PVC insulated

KOD CODE	L mm	L inch	g		TL/Ad.
3715 16 0165	165	6 1/4"	140	5	79,00

**3720**

Çift Ağızlı Kablo Kesici  
Cable Cutter, Double Cutter



Özel alaşımlı çelik, Kesici ağızlar induksiyonda sertleştirilmiş, PVC izoleli  
Special steel, Cutters induction hardened, PVC insulated

KOD CODE	L mm	L inch	g		TL/Ad.
3720 16 0220	220	8"	320	5	106,00

**3860**

Testere Çaprazı  
Saw - Setting Pliers

TSEK



Özel alaşımlı çelik, İndüksiyonda sertleştirilmiş,  
Natural Vernikli, PVC izoleli  
Special steel, induction hardened, PVC insulated

KOD CODE	L mm	L inch	g		TL/Ad.
3860 26 0180	180	7 1/8"	245	5	85,65

3550

**Elektronikçi Yan Keski**  
*Electronic Diagonal Side Cutting Pliers*



Özel alaşımli çelik  
*Special steel*

KOD CODE	L mm	g	TL/Ad.
3550 14 0125	125	76	5 68,20

3553

**Elektronikçi Düz Uçlu Kargaburun**  
*Electronic Flat Nose Pliers*



Özel alaşımli çelik  
*Special steel*

KOD CODE	L mm	g	TL/Ad.
3553 14 0150	150	88	5 68,00

4

3551

**Elektronikçi Tepe Keski**  
*Electronic End Cutting Pliers*



Özel alaşımli çelik  
*Special steel*

KOD CODE	L mm	g	TL/Ad.
3551 14 0125	125	77	5 68,20

3554

**Elektronikçi Uzun Kargaburun**  
*Electronic Long Nose Pliers*



Özel alaşımli çelik  
*Special steel*

KOD CODE	L mm	g	TL/Ad.
3554 14 0150	150	88	5 68,00

3552

**Elektronikçi Yuvarlak Uçlu Kargaburun**  
*Electronic Round Nose Pliers*



Özel alaşımli çelik  
*Special steel*

KOD CODE	L mm	g	TL/Ad.
3552 14 0125	125	78	5 68,20

3555

**Elektronikçi Sivri Uçlu Düz Kargaburun**  
*Electronic Needle Flat Nose Pliers*



Özel alaşımli çelik  
*Special steel*

KOD CODE	L mm	g	TL/Ad.
3555 14 0150	150	86	5 68,00



3556

Elektronikçi Sivri Uçlu Eğri Kargaburun  
Electronic Needle Bent Nose Pliers



Özel alaşımlı çelik  
Special steel

KOD CODE	L mm	g	TL/Ad.
3556 14 0150	150	85	68,00

3557

Elektronikçi Pense  
Electronic Pliers



Özel alaşımlı çelik  
Special steel

KOD CODE	L mm	g	TL/Ad.
3557 14 0125	125	80	68,20

3560 00 2104

Elektronikçi Keski ve Pense Seti (4 Parça)  
Electronic Cutter & Pliers Set (4 Pcs)



KOD CODE	L mm	İÇERİK CONTENTS	TL Ad.
3550 14 0125	125	<b>Elektronikçi Yan Keski</b> Electronic Diagonal Side Cutting Pliers	1
3551 14 0125	125	<b>Elektronikçi Tepe Keski</b> Electronic End Cutting Pliers	1
3554 14 0150	150	<b>Elektronikçi Uzun kargaburun</b> Electronic Long Nose Pliers	1
3557 14 0125	125	<b>Elektronikçi Pense</b> Electronic Pliers	1
			272,60

3565 00 2104

Elektronikçi Kargaburun Seti (4 Parça)  
Electronic Long Nose Pliers Set (4 Pcs)



KOD CODE	L mm	İÇERİK CONTENTS	TL Ad.
3552 14 0125	125	<b>Elektronikçi Yuvarlak Uçlu Kargaburun</b> Electronic Round Nose Pliers	1
3553 14 0150	150	<b>Elektronikçi Düz Uçlu Kargaburun</b> Electronic Flat Nose Pliers	1
3555 14 0150	150	<b>Elektronikçi Sivri Uçlu Düz Kargaburun</b> Electronic Needle Nose Pliers	1
3556 14 0150	150	<b>Elektronikçi Sivri Uçlu Eğri Kargaburun</b> Electronic Bent Needle Nose Pliers	1
			272,20

4

3800

Kerpeten  
Carpenter Pincers

TS 60 - TS ISO 9243  
DIN ISO 9243



Özel alaşımlı çelik,  
Kesici ağızlar indüksiyonda sertleştirilmiş,  
Vernikli, PVC izoleli  
Special steel, Cutters induction hardened,  
Lacquered, PVC insulated

KOD CODE	L mm	L inch	g	TL/Ad.
3800 15 0160	160	6 1/4"	220	53,00
3800 15 0180	180	7 1/8"	295	54,85
3800 15 0200	200	8"	330	73,15
3800 15 0250	250	10"	530	79,70

3830

Betoncu Kerpeteni  
Tower Pincers

TS 60 • TS ISO 9242  
DIN ISO 9242



Özel alaşımlı çelik, Kesici ağızlar indüksiyonda sertleştirilmiş,  
Vernikli, PVC izoleli  
Special steel, Cutters induction hardened,  
Lacquered, PVC insulated

KOD CODE	L mm	L inch	g	TL/Ad.
3830 15 0225	225	9"	345	65,80
3830 15 0250	250	10"	395	72,70
3830 15 0280	280	11"	450	81,35

3831

Betoncu Kerpeteni Yaylı  
Tower Pincers with spring

TS 60 - TS ISO 9242  
DIN ISO 9242



Özel alaşımlı çelik, Kesici ağızlar indüksiyonda sertleştirilmiş,  
Vernikli, PVC izoleli  
Special steel, Cutters induction hardened,  
Lacquered, PVC insulated

KOD CODE	L mm	L inch	g	TL/Ad.
3831 15 0280	280	11"	455	89,25

3835

Ağır Tip Betoncu Kerpeteni  
Heavy Duty Tower Pincers

TS 60 - TS ISO 9242  
DIN ISO 9242



Özel alaşımlı çelik, Kesici ağızlar indüksiyonda sertleştirilmiş,  
Vernikli, PVC izoleli  
Special steel, Cutters induction hardened,  
Lacquered, PVC insulated

KOD CODE	L mm	L inch	g	TL/Ad.
3835 15 0280	280	11"	435	88,50

3850

Danallya  
Shoemaker Pliers



Özel alaşımlı çelik, İndüksiyonda sertleştirilmiş,  
Siyah Oksit kaplı  
Special steel, Induction hardened, Black finish

KOD CODE	L mm	L inch	g	TL/Ad.
3850 12 0200	200	8"	360	114,90

# 5

## 1000V İzoleli Aletler 1000V Insulated Tools



VDE belgeli ürünler ilgili uluslararası standartlara göre kontrol edildikten sonra ek olarak 5 ayrı teste tabi tutulur.

- 1- Voltaj Testi : 3 dakika boyunca 10.000 V'a tabi tutulan izoleli el aletinde kaçak yada elektrik akımı atlama olmamalıdır.
- 2- Soğuk Şoklama Testi : -24 derece 2 saat bekletilmiş (şoklanmış) el aletine 60-80 cm yükseklikten 600gr ağırlık ile darbeler uygulanır. İzolede kırılma yada çatlama olmamalıdır.
- 3- Dayanıklılık Testi : +70 derece 1 hafta bekletilmiş el aletine 50kg yük ile sap sökme testi uygulanır. Sap yerinden çıkmamalıdır.
- 4- Geçirgenlik Testi : 5000V elektrik akımına karşı 3 dakika boyunca 2kg sivri uçlu ağırlıkta baskı yapılarak elektrik verilir. Kaçak yada elektrik atlama olmamalıdır.
- 5- Yanma Testi : Yüksek yoğunluktaki alev 20 saniye maruz bırakılarak teste tabi tutulur. Alevden uzaklaştırılan izole yanmaya devam etmemelidir.

After internationally recognised standard controls, VDE certified hand tools are passed through 5 additional tests.

- 1- Voltage test : For 3 minutes under 10.000V, no current leak should occur in the handle
- 2- Cold shock test : Tools are kept in -24 degrees Celcius for 2 hours. A mass with 600gr is dropped on the handle from 60-80cm. No crack or break on the handle should occur.
- 3- Durability test : Tools are kept in +70 degrees Celcius for 1 week. When a force of 50kg is applied, handle should not pull away from the tool.
- 4- Conductivity test : Under 5.000V, a mass of 2 kg with a point tip is pressed onto the handle for 3 minutes. No current leakage should occur.
- 5- Flame retardancy test: When applied to an open flame for 20 seconds, handle material should not catch flame.

0255

Süper İzole Çatal Bir Ağız Anahtar (mm)  
Single Ended Open Jaw Wrench  
Super Insulated (mm)



Krom vanadyum, Krom kaplı, Kalın PVC izoleli  
Chrom vanadium, Chrom plated, Triple PVC insulated

5

KOD CODE	mm	L mm	g		TL/Ad.
0255 01 0010	10	110	40	10	27,65
0255 01 0011	11	120	45	10	29,20
0255 01 0012	12	130	50	10	30,50
0255 01 0013	13	140	60	10	32,90
0255 01 0014	14	155	75	10	34,15
0255 01 0017	17	170	100	10	41,90
0255 01 0019	19	185	150	10	49,20
0255 01 0022	22	200	200	10	66,20
0255 01 0024	24	220	280	10	81,00

0435

Süper İzoleli Bir Ağız Yıldız Anahtar (mm)  
Single Ended Ring Wrench Super  
Insulated (mm)



Krom vanadyum, Krom kaplı, Kalın PVC izoleli  
Chrom vanadium, Chrom plated, Triple PVC insulated

KOD CODE	mm	L mm	g		TL/Ad.
0435 03 0010	10	170	100	10	36,95
0435 03 0011	11	180	110	10	36,95
0435 03 0012	12	190	130	10	41,90
0435 03 0013	13	200	150	10	41,90
0435 03 0014	14	215	180	10	44,00
0435 03 0017	17	230	220	10	49,85
0435 03 0019	19	245	270	10	59,50
0435 03 0022	22	260	310	10	65,20
0435 03 0024	24	280	420	10	87,15

2400

1000V İzoleli Ünsel Fort Pense  
Insulated Type Waterpump  
Pliers Universal 1000V

TSE  
TS 60  
TS ISO 8976

YENİ  
NEW



Krom vanadyum, Krom kaplı, çift komponent saplı  
Chrom vanadium, Chrom plated, Two component handle

KOD CODE	L mm	L inch	mm	g		TL/Ad.
2400 11 6240	240	9 1/2"	35	370	5	94,50

3020

1000V İzoleli Elektrikçi Kombine Pense  
Insulated Electrician Type  
Combination Plier 1000V

TSE  
TS ISO 5746  
DIN ISO 5746  
1000 V  
IEC 60900

YENİ  
NEW



Özel alaşımli çelik, Kesici ağızlar indüksiyonda sertleştirilmiş, Krom kaplı  
Special steel, Cutters induction hardened, Chrom plated



KOD CODE	L mm	L inch	MODEL	g		TL/Ad.
3020 12 6160	160	6 1/4"	1000V	205	5	76,00
3020 12 6180	180	7 1/8"	1000V	260	5	81,35
3020 12 6200	200	8"	1000V	345	5	91,90

3220

1000V İzoleli Elektrikçi Kargaburun  
Insulated Electrician Type  
Nose Plier 1000V

YENİ  
NEW



TS 60  
TS ISO 5745  
DIN ISO 5745  
△ 1000 V  
IEC 60900



Özel alaşımli çelik, Kesici ağızlar indüksiyonda sertleştirilmiş, Krom kaplı  
Special steel, Cutters induction hardened, Chrom plated

KOD CODE	L mm	L inch	MODEL	g	TL/Ad.
3220 13 6140	140	5 1/2"	1000V	110	81,50
3220 13 6160	160	6 1/4"	1000V	140	90,10
3220 13 6180	180	7 1/8"	1000V	160	101,15
3220 13 6200	200	8"	1000V	170	105,00

3700

1000V İzoleli Elektrikçi Yan Keski  
Insulated Electrician Type Side Cutter 1000V

YENİ  
NEW



TS 60  
TS ISO 5749  
DIN ISO 5749  
△ 1000 V  
IEC 60900



Özel alaşımli çelik, Kesici ağızlar indüksiyonda sertleştirilmiş, Krom kaplı  
Special steel, Cutters induction hardened, Chrom plated

KOD CODE	L mm	L inch	MODEL	g	TL/Ad.
3700 16 6140	140	5 1/2"	1000V	165	84,55
3700 16 6160	160	6 1/4"	1000V	215	95,95
3700 16 6180	180	7 1/8"	1000V	225	107,40

4140

1000V İzoleli Elektrikçi Düz Uçlu Tornavida  
Insulated Electrician Type Flat  
Screwdriver 1000V

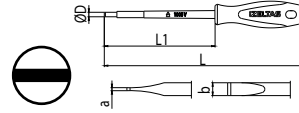

TS 59  
TS ISO 2380-1  
DIN ISO 2380-1  
△ 1000 V  
IEC 60900



Krom vanadyum, Siyah oksit kaplı  
Chrom vanadium, Black finish

KOD CODE	øDxL1 mm	a b		L mm	g	TL/Ad.	
		mm	mm				
4140 17 2575	2.5x75	0.4	2.5	150	25	10	12,15
4140 17 4100	4x100	0.8	4	185	40	10	14,30
4140 17 5512	5.5x125	1	5.5	220	70	10	18,90
4140 17 6515	6.5x150	1.2	6.5	245	90	10	21,20

4145

1000V İzoleli Elektrikçi Yıldız Uçlu Tornavida  
Insulated Electrician Type Phillips  
Screwdriver 1000V

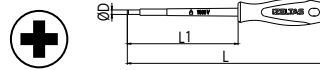

TS 59 TS 59-5  
ISO 8764 DIN ISO 8764  
△ 1000 V  
IEC 60900



Krom vanadyum, Siyah oksit kaplı  
Chrom vanadium, Black finish

KOD CODE	øDxL1 mm	+	L mm	g	TL/Ad.	
4145 18 0360	3x60	Ph0	135	25	10	12,70
4145 18 4580	4.5x80	Ph1	165	45	10	17,95
4145 18 6100	6x100	Ph2	195	70	10	21,20

4140

1000V İzoleli Elektrikçi Tornavida Seti (6 Parça)  
Insulated Electrician Set (6 Pcs) Screwdriver 1000V

YENİ  
NEW



KOD CODE	İÇERİK CONTENTS	g	TL/Ad.
4140 00 9106	2.5x75 - 4x100 Düz uçlu / Flat	340	6
	4.5x80 - 6x100 Yıldız uçlu / Phillips		

4773

1000V Süngüsü İzoleli Lokma Uçlu Tornavida  
Nut Spinner, Electrician Blade Insulated  
1000V

DIN 3125

YENİ  
NEW

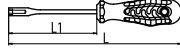

Krom vanadyum, iki komponent saplı  
Chrome vanadium, Two component handle

5

KOD CODE	mm	L mm	L1 mm	g		TL/Ad.
4773 19 0040	4	220	125	90	10	41,10
4773 19 0050	5	220	125	90	10	41,10
4773 19 0055	5.5	220	125	90	10	41,10
4773 19 0060	6	220	125	90	10	41,10
4773 19 0070	7	230	125	110	10	44,10
4773 19 0080	8	230	125	120	10	44,10
4773 19 0090	9	230	125	125	10	47,60
4773 19 0100	10	230	125	125	10	47,60
4773 19 0110	11	230	125	140	10	52,00
4773 19 0120	12	230	125	145	10	55,80
4773 19 0130	13	230	125	150	10	60,10
4773 19 0140	14	230	125	150	10	66,50

4773

1000V Süngüsü İzoleli Lokma Uçlu Tornavida Seti (8 Parça)  
Nut Spinner, Electrician Blade Insulated Set (8 Pcs)  
1000V

YENİ  
NEW



KOD CODE	İÇERİK CONTENTS	g		TL/Ad.
4773 00 8108	6 - 7 - 8 - 9 - 10 - 11 - 12 - 13	2225	8	392,40

4783

1000V Süngüsü İzoleli Manyetik Bits Tutucu Tornavida  
Screwdriver, Magnetic Bit Holder Insulated  
1000V

1000 V  
IEC 60900

YENİ  
NEW

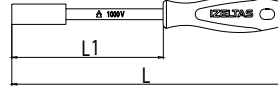

KOD CODE	mm	L mm	L1 mm	g		TL/Ad.
4783 19 6120	6.3	230	120	115	10	44,20

8795 00 6005

1000V İzoleli Elektrikçi Seti (5 Parça)  
1000V Insulated Tool Set (5 Pcs)

YENİ  
NEW



KOD CODE	İÇERİK CONTENTS		TL/Ad.
3020 12 6180	<b>180 mm 1000V İzoleli Elektrikçi Kombine Pense</b> Insulated Electrician Type Combination Pliers 1000V	1	322,40
3220 13 6200	<b>200 mm 1000V İzoleli Elektrikçi Kargaburun</b> Insulated Electrician Type Nose Pliers	1	
3700 16 6160	<b>160 mm 1000V İzoleli Elektrikçi Yankeki</b> Insulated Electrician Type Nose	1	
4140 17 5512	<b>5.5x125 1000V Elektrikçi Düz Uçlu Tornavida</b> Insulated Electrician Type Flat Screwdriver 1000V	1	
4145 18 6100	<b>6x100 1000V İzoleli Elektrikçi Yıldız Uçlu Tornavida</b> Insulated Electrician Type Phillips Screwdriver 1000V	1	

6

# Tornavida ve Allen Anahtarlar

## Screwdrivers and Hex Key Wrenches



*Tornavidalar* Screwdrivers  
*Kontrol Kalemleri* Testers  
*Bits Uçlar ve Aparatları* Bits  
*Allen Anahtarlar* Hex Key Wrenches

4550

Elektrik Kontrol Kalemi (Düz Uçlu)  
Voltage Tester (Flat)

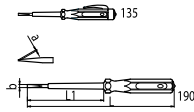

**Krom vanadyum, Krom kaplı, Şeffaf selüloz asetat saplı**  
Chrom vanadium, Chrom plated, Transparent cellulose acetate handle

KOD CODE	L mm	⊖		L1 mm	g	□	TL/Ad.
		a mm	b mm				
4550 17 0135	135	0.5	3	60	20	10	12,90
4550 17 0190	190	0.8	4	100	40	10	16,20

4555

Master Kontrol Kalemi (Düz Uçlu)  
Voltage Tester Master (Flat)

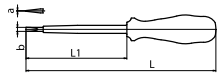

**Krom vanadyum, Krom kaplı, Şeffaf selüloz asetat saplı**  
Chrom vanadium, Chrom plated, Transparent cellulose acetate handle

KOD CODE	L mm	⊖		L1 mm	g	□	TL/Ad.
		a mm	b mm				
4555 17 0165	165	0.5	3.5	88	40	10	17,80

4560

Elektrik Kontrol Kalemi (Yıldız Uçlu)  
Voltage Tester Phillips

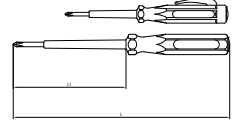

**Krom vanadyum, Krom kaplı, Şeffaf selüloz asetat saplı**  
Chrom vanadium, Chrom plated, Transparent cellulose acetate handle

KOD CODE	L mm	L1 mm	+	g	□	TL/Ad.
4560 18 0135	135	60	Ph0	20	10	14,10
4560 18 0190	190	100	Ph0	35	10	17,80

4565

Oto Kontrol Kalemi  
Car Voltage Tester

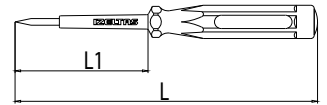

**Krom vanadyum, Krom kaplı, Şeffaf selüloz asetat saplı**  
Chrom vanadium, Chrom plated, Transparent cellulose acetate handle

Tüm otomobil ve ağır vasıta araçlarda 6-24V arası elektrik tesisatının kontrol edilmesinde kullanılır. Sivri uçlu olması sebebiyle kablo ve soketleri yerinden sökmeden kontrol kolaylığı sağlar.

Tool is used to control 6-24V electrical wiring in all cars and heavy duty vehicles. With its point tip, wires and sockets are not required to be disassembled.

KOD CODE	L mm	L1 mm	⊖	Kablo L (m)	g	□	TL/Ad.
4565 17 0135	135	60		1	30	10	34,80



4100

Kraft Seri Düz Uçlu Tornavida  
Screwdriver, Kraft, Flat

TS ISO 2380 - 1  
DIN ISO 2380-1



Krom vanadyum, Krom kaplı, Ucu siyah oksit, Selüloz asetat saplı  
Chrom vanadium, Chrom plated and black tip,  
Cellulose acetate handle

KOD CODE	øDxL1 mm	⊖		L mm	g	□	TL/Ad.
		a mm	b mm				
4100 17 0340	3x40	0.5	3	110	20	10	9,50
4100 17 0380	3x80	0.5	3	155	35	10	10,05
4100 17 0480	4x80	0.8	4	165	50	10	10,85
4100 17 4100	4x100	0.8	4	185	50	10	12,60
4100 17 0580	5x80	1.0	5.5	175	70	10	13,35
4100 17 5100	5x100	1.0	5.5	195	75	10	14,70
4100 17 5125	5x125	1.0	5.5	220	80	10	16,85
4100 17 5150	5x150	1.0	5.5	245	80	10	18,35
4100 17 6100	6x100	1.2	6.5	195	85	10	15,10
4100 17 6125	6x125	1.2	6.5	220	90	10	17,30
4100 17 6150	6x150	1.2	6.5	245	95	10	18,95
4100 17 6175	6x175	1.2	6.5	270	100	10	24,40
4100 17 7125	7x125	1.2	8	230	120	10	19,25
4100 17 7150	7x150	1.2	8	255	130	10	22,30
4100 17 7175	7x175	1.2	8	280	135	10	25,55
4100 17 8150	8x150	1.6	10	255	145	10	25,35
4100 17 8175	8x175	1.6	10	280	150	10	27,00
4100 17 8200	8x200	1.6	10	305	160	10	33,05
4100 17 9200	9x200	2.0	12	305	190	10	35,30
4100 17 1125	11x250	2.5	14	365	305	10	44,85



4100

Kraft Seri Düz Uçlu Tornavida Seti (8 Parça)  
Screwdriver, Flat, Kraft Set (8 Pcs)



KOD CODE	İÇERİK CONTENTS	g	□	TL/Ad.
4100 00 8108	3x80 - 4x80 - 4x100 5x100 - 5x125 - 6x100 6x125 - 6x150 ⊖ Düz uçlu / Flat	550	8	116,40

4100

Kraft Seri Süngüsü Uzun Düz Uçlu Tornavida  
Screwdriver, Kraft, Flat, Long

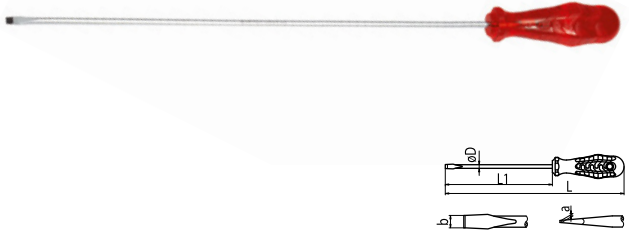

Krom vanadyum, Krom kaplı, Ucu siyah oksit, Selüloz asetat saplı  
Chrom vanadium, Chrom plated and black tip,  
Cellulose acetate handle

KOD CODE	øDxL1 mm	⊖		L mm	g	□	TL/Ad.
		a mm	b mm				
4100 17 4300	4x300	0.8	4	385	70	10	31,25
4100 17 5250	5x250	1.0	5.5	345	95	10	34,85
4100 17 5350	5x350	1.0	5.5	445	115	10	39,40
4100 17 6350	6x350	1.2	6.5	445	125	10	41,70

4120

Kraft Seri Yıldız Uçlu Tornavida  
Screwdriver, Kraft, Phillips

TS 59 - 5 ISO 8764-1  
DIN ISO 8764-1

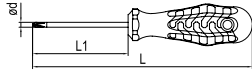

Krom vanadyum, Krom kaplı, Ucu siyah oksit, Selüloz asetat saplı  
Chrom vanadium, Chrom plated and black tip,  
Cellulose acetate handle.

KOD CODE	ØdxL1 mm	+	L mm	g	TL/Ad.
4120 18 0360	3x60	Ph0	135	30	10,70
4120 18 4580	4.5x80	Ph1	165	55	15,40
4120 18 5100	4.5x100	Ph1	185	55	17,15
4120 18 5150	4.5x150	Ph1	235	60	20,55
4120 18 6100	6x100	Ph2	195	85	18,60
4120 18 6150	6x150	Ph2	245	95	22,30
4120 18 6200	6x200	Ph2	295	105	28,90
4120 18 8150	8x150	Ph3	255	150	35,35
4120 18 1200	10x200	Ph4	315	240	54,65

4120

Kraft Seri Süngüsü Uzun Yıldız Uçlu Tornavida  
Screwdriver, Kraft, Phillips, Long

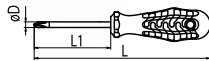

Krom vanadyum, Krom kaplı, Ucu siyah oksit, Selüloz asetat saplı  
Chrom vanadium, Chrom plated and black tip,  
Cellulose acetate handle

KOD CODE	ØDxL1 mm	+	L mm	g	TL/Ad.
4120 18 5300	4.5x300	Ph1	385	80	48,80
4120 18 6300	6x300	Ph2	395	125	50,45

4120

Kraft Seri Yıldız Uçlu Tornavida Seti (6 parça)  
Screwdriver, Kraft, Phillips, Set (6 Pcs)



KOD CODE	İÇERİK CONTENTS	g	TL/Ad.
4120 00 8106	3x60 - 4.5x80 4.5x100 - 4.5x150 6x100 - 6x150 Yıldız uçlu / Phillips	380	104,70

4100

Kraft Seri Tornavida Seti (7 parça)  
Screwdriver Set, Kraft (7 Pcs)



KOD CODE	İÇERİK CONTENTS	g	TL/Ad.
4100 00 8107	3x80 - 4x80 - 4x100 5x125 - 6x150 Düz uçlu / Flat 4.5x80 - 6x100 Yıldız uçlu / Phillips	445	103,30

## 4110

Kraft Seri Düz Uçlu Topaç Tornavida  
Screwdriver, Kraft, Stubby, Flat

TS 59

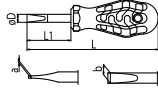

Krom vanadyum, Krom kaplı, Ucu siyah oksit, Selüloz asetat saplı  
Chrom vanadium, Chrom plated and black tip,  
Cellulose acetate handle

KOD CODE	øDxL1 mm	⊖		L mm	g	□	TL/Ad.
		a mm	b mm				
4110 17 5525	5.5x25	1	5.5	70	30	5	10,95
4110 17 5540	5.5x40	1	5.5	105	45	5	14,85
4110 17 6525	6.5x25	1.2	6.5	70	35	5	12,15
4110 17 6540	6.5x40	1.2	6.5	105	50	5	16,85

## 4130

Kraft Seri Yıldız Uçlu Topaç Tornavida  
Screwdriver, Kraft, Stubby, Phillips

TS 59 - 5

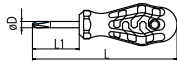

Krom vanadyum, Krom kaplı, Ucu siyah oksit, Selüloz asetat saplı  
Chrom vanadium, Chrom plated and black tip,  
Cellulose acetate handle

KOD CODE	øDxL1 mm	⊕	L mm	g	□	TL/Ad.
4130 18 4540	4.5x40	Ph1	105	40	5	14,75
4130 18 0625	6x25	Ph2	70	30	5	12,25
4130 18 0640	6x40	Ph2	105	50	5	16,65

## 4140

1000V İzoleli Elektrikçi Düz Uçlu Tornavida  
Insulated Electrician Type Flat  
Screwdriver 1000V

TS 59 TS ISO 2380-1  
DIN ISO 2380-1  
⚡ 1000 V  
IEC 60900

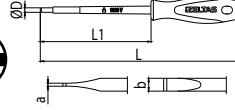

Krom vanadyum, Siyah oksit kaplı  
Chrom vanadium, Black finish

KOD CODE	øDxL1 mm	⊖		L mm	g	□	TL/Ad.
		a mm	b mm				
4140 17 2575	2.5x75	0.4	2.5	150	25	10	12,15
4140 17 4100	4x100	0.8	4	185	40	10	14,30
4140 17 5512	5.5x125	1	5.5	220	70	10	18,90
4140 17 6515	6.5x150	1.2	6.5	245	90	10	21,20

## 4145

1000V İzoleli Elektrikçi Yıldız Uçlu Tornavida  
Insulated Electrician Type Phillips  
Screwdriver 1000V

TS 59 TS 59-5  
ISO 8764 DIN ISO 8764  
⚡ 1000 V  
IEC 60900

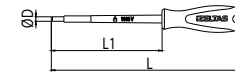

Krom vanadyum, Siyah oksit kaplı  
Chrom vanadium, Black finish

KOD CODE	øDxL1 mm	⊕	L mm	g	□	TL/Ad.
4145 18 4580	4.5x80	Ph1	165	45	10	17,95
4145 18 6100	6x100	Ph2	195	70	10	21,20

## 4140

1000V İzoleli Elektrikçi Tornavida Seti (6 Parça)  
Insulated Electrician Set (6 Pcs) Screwdriver 1000V



KOD CODE	İÇERİK CONTENTS	g	□	TL/Ad.

4300

Opak Seri Düz Uçlu Tornavida  
Screwdriver, Opak, Flat

TS ISO 2380-1  
DIN ISO 2380-1

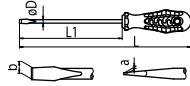

Krom vanadyum, Krom kaplı, Ucu siyah oksit, PP saplı  
Chrome vanadium, Chrom plated and black tip, PP handle

KOD CODE	øDxL1 mm	-		L mm	g	□	TL/Ad.
		a mm	b mm				
4300 17 0380	3x80	0.5	3	155	25	10	8,85
4300 17 0480	4x80	0.8	4	165	35	10	9,15
4300 17 4100	4x100	0.8	4	185	40	10	10,95
4300 17 5100	5x100	1.0	5.5	195	60	10	13,25
4300 17 5125	5x125	1.0	5.5	220	60	10	15,40
4300 17 6100	6x100	1.2	6.5	195	65	10	13,75
4300 17 6125	6x125	1.2	6.5	220	70	10	15,75
4300 17 6150	6x150	1.2	6.5	245	80	10	17,20
4300 17 7125	7x125	1.2	8	230	95	10	17,60
4300 17 7150	7x150	1.2	8	255	105	10	20,25
4300 17 8175	8x175	1.6	10	280	130	10	24,60
4300 17 9200	9x200	2.0	12	305	165	10	32,50

6

4300

Opak Seri Tornavida Seti (7 Parça)  
Screwdriver Set, Opak (7 Pcs)



KOD CODE	İÇERİK CONTENTS	g	□	TL/Ad.
4300 00 8107	3x80 - 4x80 - 4x100	520	7	92,50
	5x125 - 6x150			
	<b>Düz uçlu / Flat</b> 4.5x80 - 6x100 <b>Yıldız uçlu / Phillips</b>			

4320

Opak Seri Yıldız Uçlu Tornavida  
Screwdriver, Opak, Phillips

TS 59 - 5 ISO 8764  
DIN ISO 8764

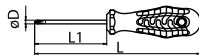

Krom vanadyum, Krom kaplı, Ucu siyah oksit, PP saplı  
Chrome vanadium, Chrom plated and black tip, PP handle

KOD CODE	øDxL1 mm	+	L mm	g	□	TL/Ad.
4320 18 0360	3x60	Ph0	135	25	10	9,75
4320 18 4580	4.5x80	Ph1	165	40	10	14,00
4320 18 6100	6x100	Ph2	195	70	10	16,95
4320 18 8150	8x150	Ph3	255	140	10	32,15

4325

Opak Seri Pozidriv Yıldız Uçlu Tornavida  
Screwdriver, Opak, Pozidriv

DIN ISO 8764

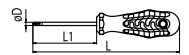

Krom vanadyum, Krom kaplı, Ucu siyah oksit, PP saplı  
Chrome vanadium, Chrom plated and black tip, PP handle

KOD CODE	øDxL1 mm	+	L mm	g	□	TL/Ad.
4325 18 0360	3x60	Pz0	135	25	10	10,70
4325 18 4580	4.5x80	Pz1	165	40	10	15,40
4325 18 6100	6x100	Pz2	195	70	10	18,60
4325 18 8150	8x150	Pz3	255	140	10	35,35

## 4350

Ergonomik Seri Düz Uçlu Tornavida  
Screwdriver, Ergonomic, Flat

TS ISO 2380 - 1  
DIN ISO 2380-1

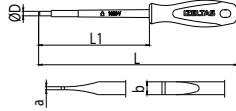

Krom vanadyum, Krom kaplı, Ucu siyah oksit, İki komponent saplı  
Chrome vanadium, Chrom plated and black tip,  
Two component handle.

KOD CODE	ØDxL1 mm	-		L mm	g	TL/Ad.
		a mm	b mm			
4350 17 0380	3x80	0.5	3	155	25	10,95
4350 17 0480	4x80	0.8	4	165	40	11,50
4350 17 4100	4x100	0.8	4	185	40	13,10
4350 17 5100	5x100	1.0	5.5	195	60	15,10
4350 17 5125	5x125	1.0	5.5	220	65	17,45
4350 17 6100	6x100	1.2	6.5	195	70	15,60
4350 17 6125	6x125	1.2	6.5	220	75	17,90
4350 17 6150	6x150	1.2	6.5	245	80	19,60
4350 17 7125	7x125	1.2	8	230	100	20,00
4350 17 7150	7x150	1.2	8	255	110	23,00
4350 17 8175	8x175	1.6	10	280	140	27,95
4350 17 9200	9x200	2	12	305	180	35,70

## 4350

Ergonomik Seri Tornavida Seti (7 Parça)  
Screwdriver Set, Ergonomic (7 Pcs.)



KOD CODE	İÇERİK CONTENTS	g	TL/Ad.
4350 00 8107	3x80 - 4x80 - 4x100	370	7
	5x125 - 6x150		
	Düz uçlu / Flat		
	4.5x80 - 6x100		
	Yıldız uçlu / Phillips		107,90

6

## 4370

Ergonomik Seri Yıldız Uçlu Tornavida  
Screwdriver, Ergonomic, Phillips

TS 59 - 5  
ISO 8764-1  
DIN ISO 8764-1



Krom vanadyum, Krom kaplı, Ucu siyah oksit, İki komponent saplı  
Chrome vanadium, Chrom plated and black tip,  
Two component handle

KOD CODE	ØDxL1 mm	+	L mm	g	TL/Ad.
4370 18 0360	3x60	Ph0	135	25	11,15
4370 18 4580	4.5x80	Ph1	165	45	15,95
4370 18 6100	6x100	Ph2	195	70	19,35
4370 18 8150	8x150	Ph3	255	130	36,55



4240

Değişken Uçlu Tornavida  
Screwdriver - Reversible

TSEK



Krom vanadyum, Krom kaplı, Selüloz asetat saplı  
Chrom vanadium, Chrom plated, Cellulose acetate handle

KOD CODE	øDxL1 mm	-		+	L mm	g	TL/Ad.
		a	b				
4240 17 0680	6x80	1.2x6	Ph2	175	80	10	19,45

4500

Elektronikçi Tip (Klemens) Düz Uçlu Tornavida  
Electronic Screwdriver, Flat



Krom vanadyum, Krom kaplı, Ucu siyah oksit, PP saplı  
Chrome vanadium, Chrom plated and black tip, PP handle

KOD CODE	øDxL1 mm	-		L mm	g	TL/Ad.	
		a	b				
4500 17 2560	2.5x60	0.4	2.5	140	15	10	8,10
4500 17 2580	2.5x80	0.4	2.5	160	15	10	9,00
4500 17 0380	3x80	0.5	3	160	15	10	9,55
4500 17 3100	3x100	0.5	3	180	20	10	11,65
4500 17 3125	3x125	0.5	3	205	20	10	15,40
4500 17 3510	3.5x100	0.6	3.5	180	20	10	12,05
4500 17 0480	4x80	0.8	4	160	20	10	9,80
4500 17 4100	4x100	0.8	4	180	20	10	12,05
4500 17 4125	4x125	0.8	4	205	25	10	16,20
4500 17 4150	4x150	0.8	4	230	25	10	17,65

6

Değişken Uçlu Tornavida Takımı  
Screwdriver Set - Reversible

TSEK



KOD CODE	øDxL1 mm	-		+	L mm	g	TL/Ad.
		a	b				
4240 00 7102	6x80	1.2x6	Ph2	175	105	1	37,10
	4x80	0.8x4.5	Ph1				

4540

Klips Sökme Tornavidası  
Hupcap and Clip Remover

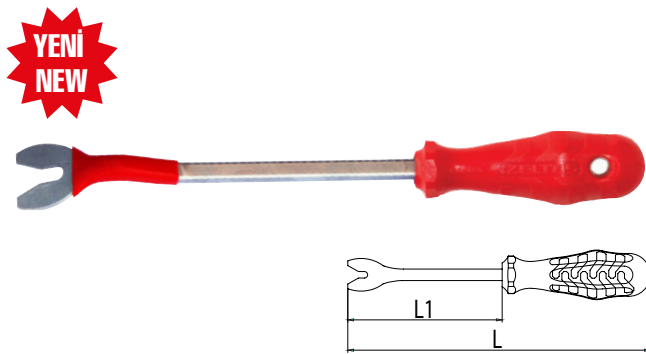

Krom vanadyum, Krom kaplı, PP Saplı  
Chrom vanadium, Chrom plated, PP insulated

KOD CODE	L mm	L1	g	TL/Ad.	
4540 19 0190	290	180	160	10	37,70

4520

Elektronikçi Tip (Klemens) Yıldız Uçlu Tornavida  
Electronic Screwdriver, Phillips



Krom vanadyum, Krom kaplı, Ucu siyah oksit, PP saplı  
Chrome vanadium, Chrom plated and black tip, PP handle

KOD CODE	øDxL1 mm	+	L mm	g	TL/Ad.	
4520 18 0360	3x60	Ph0	140	15	10	10,05
4520 18 0480	4x80	Ph0	160	20	10	14,50
4520 18 4150	4x150	Ph0	230	25	10	19,40

4500

Elektronikçi Tip (Klemens) Tornavida Seti (6 Parça)  
Electronic Screwdriver Set (6 Pcs)



KOD CODE	İÇERİK CONTENTS	g	TL/Ad.
4500 00 8106	3x80 - 3x100 3x125 - 4x150 Düz uçlu / Flat 3x60 - 4x80 Yıldız uçlu / Phillips	115	6 78,80

4530

Elektronikçi Tip (Klemens) Torx® Uçlu Tornavida  
Electronic Screwdriver, Torx®

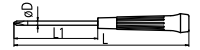

Krom vanadyum, Krom kaplı, Ucu siyah oksit, PP saplı  
Chrome vanadium, Chrom plated and black tip, PP handle

KOD CODE	ØDxL1 mm	★	L mm	g	TL/Ad.
4530 17 0560	2.5x60	T5	145	15	10,70
4530 17 0660	2.5x60	T6	145	15	10,70
4530 17 0760	3x60	T7	145	15	11,05
4530 17 0860	3x60	T8	145	20	11,05
4530 17 0960	3x60	T9	145	20	11,05
4530 17 1060	3.5x60	T10	145	20	11,05

4530

Elektronikçi Tip (Klemens) Torx® Uçlu Tornavida Seti (6 Parça)  
Electronic Screwdriver Set Torx (6 Pcs)



KOD CODE	İÇERİK CONTENTS	g	TL/Ad.
4530 00 1006	T5 - T6 - T7 - T8 - T9 - T10	115	6 65,60

4765

T Kol Lokma Uçlu Tornavida (mm)  
Nut Spinner With T-Handle (mm)

YENİ  
NEW

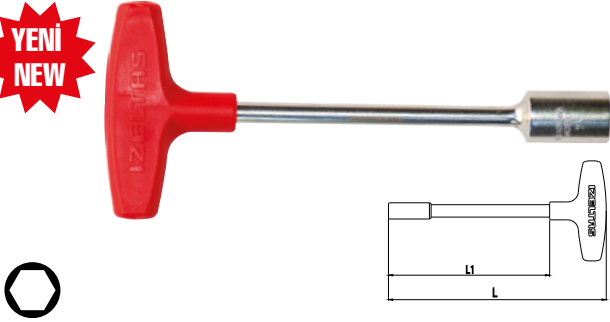

Krom vanadyum, Krom kaplı, PP Saplı  
Chrom vanadium, Chrom plated, PP insulated

KOD CODE	mm	L mm	L1 mm	g		TL/Ad.
4765 19 0040	4	185	135	75	10	24,10
4765 19 0050	5	185	135	75	10	24,10
4765 19 0055	5.5	185	135	75	10	24,10
4765 19 0060	6	185	135	75	10	24,10
4765 19 0070	7	185	135	90	10	25,75
4765 19 0080	8	185	135	95	10	25,75
4765 19 0090	9	185	135	100	10	28,55
4765 19 0100	10	185	135	100	10	28,55
4765 19 0110	11	185	135	110	10	31,55
4765 19 0120	12	185	135	110	10	32,60
4765 19 0130	13	185	135	115	10	34,05
4765 19 0140	14	185	135	115	10	39,65

4770

Lokma Uçlu Tornavida (mm)  
Nut Spinner (mm)

DIN 3125



Krom vanadyum, Krom kaplı, PP Saplı  
Chrom vanadium, Chrom plated, PP insulated

KOD CODE	mm	L mm	L1 mm	g		TL/Ad.
4770 19 0040	4	220	125	80	10	28,95
4770 19 0050	5	220	125	80	10	28,95
4770 19 0055	5.5	220	125	80	10	28,95
4770 19 0060	6	220	125	80	10	28,95
4770 19 0070	7	230	125	100	10	31,10
4770 19 0080	8	230	125	110	10	31,10
4770 19 0090	9	230	125	115	10	33,55
4770 19 0100	10	230	125	115	10	33,55
4770 19 0110	11	230	125	130	10	36,65
4770 19 0120	12	230	125	135	10	39,30
4770 19 0130	13	230	125	140	10	42,40
4770 19 0140	14	230	125	140	10	46,85

6



4770

Lokma Uçlu Tornavida Seti (8 Parça, mm)  
Nut Spinner Set (8 Pcs, mm)



KOD CODE	İÇERİK CONTENTS	g		TL/Ad.
4770 00 8108	6 - 7 - 8 - 9 - 10 11 - 12 - 13	2145	8	276,60



4773

1000V Süngüsü İzoleli Lokma Uçlu Tornavida  
Nut Spinner, Electrician Blade Insulated 1000V

DIN 3125

YENİ  
NEW

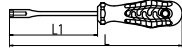

Krom vanadyum, PP saplı  
Chrome vanadium, PP handle

KOD CODE	mm	L mm	L1 mm	g	TL/Ad.	
4773 19 0040	4	220	125	90	10	41,10
4773 19 0050	5	220	125	90	10	41,10
4773 19 0055	5.5	220	125	90	10	41,10
4773 19 0060	6	220	125	90	10	41,10
4773 19 0070	7	230	125	110	10	44,10
4773 19 0080	8	230	125	120	10	44,10
4773 19 0090	9	230	125	125	10	47,60
4773 19 0100	10	230	125	125	10	47,60
4773 19 0110	11	230	125	140	10	52,00
4773 19 0120	12	230	125	145	10	55,80
4773 19 0130	13	230	125	150	10	60,10
4773 19 0140	14	230	125	150	10	66,50

4773

1000V Süngüsü İzoleli Lokma Uçlu Tornavida Seti (8 Parça)  
Nut Spinner, Electrician Blade Insulated Set (8 Pcs)  
1000V

YENİ  
NEW



KOD CODE	İÇERİK CONTENTS	g	TL/Ad.	
4773 00 8108	6 - 7 - 8 - 9 - 10 - 11 - 12 - 13	2225	8	392,40

4775

Torx® Uçlu Tornavida  
Torx® Screwdriver

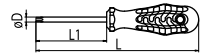
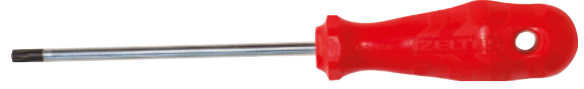

Krom vanadyum, Krom kaplı, Ucu siyah oksit, PP saplı  
Chrome vanadium, Chrom plated and blackened, PP handle

KOD CODE	ØDxL1 mm	Star	L mm	g	TL/Ad.	
4775 18 0010	4x80	T10	165	35	10	15,65
4775 18 0015	4x80	T15	165	35	10	15,65
4775 18 0020	4x100	T20	185	40	10	17,40
4775 18 0025	4.5x100	T25	185	40	10	20,15
4775 18 0027	5x125	T27	220	60	10	22,25
4775 18 0030	6x125	T30	220	70	10	23,60
4775 18 0040	7x125	T40	230	100	10	29,35
4775 18 0045	8x125	T45	230	120	10	33,15

4775

Torx® Uçlu Tornavida Seti (7 Parça)  
Torx® Screwdriver Set (7 Pcs)



KOD CODE	İÇERİK CONTENTS	g	TL/Ad.	
4775 00 8107	T10 - T15 - T20 - T25 - T27 - T30 - T40	380	7	144,05

4776

Delikli Torx® Uçlu Tornavida  
Torx® Screwdriver / Tamper Resistance

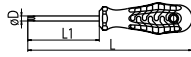

Krom vanadyum, Krom kaplı, Ucu siyah oksit, PP saplı  
Chrome vanadium, Chrom plated and blackened, PP handle

6

KOD CODE	ØDxL1 mm	☆	L mm	g	□	TL/Ad.
4776 18 0009	4x60	TR9	145	35	10	18,90
4776 18 0010	4x80	TR10	165	35	10	19,55
4776 18 0015	4x80	TR15	165	40	10	19,55
4776 18 0020	4x100	TR20	185	40	10	21,80
4776 18 0025	4.5x100	TR25	185	45	10	25,15
4776 18 0027	5x125	TR27	220	60	10	27,80
4776 18 0030	6x125	TR30	220	70	10	29,55
4776 18 0040	7x125	TR40	230	100	10	36,65

4776

Delikli Torx® Uçlu Tornavida Seti (7 Parça)  
Torx® Screwdriver / Tamper Resistance Set (7 Pcs)

YENİ NEW



KOD CODE	İÇERİK CONTENTS	g	□	TL/ Ad.
4776 00 8107	TR10 - TR15 - TR20 - TR25 - TR27 TR30 - TR40	380	7	180,05

4780

Manyetik Bits Tutucu Tornavida (Uzun)  
Screwdriver, Magnetic Bit Holder (Long)



KOD CODE	mm	L mm	L1 mm	g	□	TL/Ad.
4780 19 6120	6.3	230	120	105	10	33,95

4783

1000V Süngüsü İzoleli Manyetik Bits Tutucu Tornavida  
Screwdriver, Magnetic Bit Holder Insulated  
1000V

1000 V  
IEC 60900



YENİ NEW

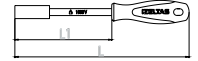

KOD CODE	mm	L mm	L1 mm	g	□	TL/Ad.
4783 19 6120	6.3	230	120	115	10	44,20

4785

Manyetik Bits Tutucu Tornavida (Kısa)  
Screwdriver, Magnetic Bit Holder, (Short)



KOD CODE	mm	L mm	L1 mm	g	□	TL/Ad.
4785 19 6330	6.3	130	30	60	10	19,45

4790

Üniversal Bits Adaptörü (Manyetik)  
Screwdriver Universal Bit Holder (Magnetic)



KOD CODE	mm	mm	L mm	g	□	TL/ Ad.
4790 26 6360	6.3	6.3	60	25	10	14,90

**4795**

**T Tipi Manyetik Bits Tutucu Tornavida**  
*Magnetic Bit Holder With T-Handle*



KOD CODE	mm	L mm	L1 mm	g		TL/Ad.
4795 19 0010	6.3	185	130	60	10	38,05

**4788**

**Manyetik Bits Tutucu Tornavida, Flexible**  
*Screwdriver, Magnetic Bit Holder, Flexible*



KOD CODE	mm	L mm	L1 mm	g		TL/Ad.
4788 19 6160	6.3	275	170	130	10	67,80

**4815**

**Değişken Bits Uçlu Tornavida Set (7 parça)**  
*Screwdriver - Interchangeable Bits Set (7 pcs)*



KOD CODE	İÇERİK CONTENTS	g		TL/Ad.
4815 00 6107	100mm Sap Ph1x4.5 Ph2x5.5 Ph3x7 Pz1x4.5 Pz2x5.5 Pz3x7	140	1	37,90

**4800**

**6'lı Bits Set**  
*Bit Set (6 Pcs)*



KOD CODE	İÇERİK CONTENTS	g		TL/Ad.
4800 00 8106	0.6x4.5 - 0.8x5.5	50	6	15,75
	Ph1 - Ph2 - Ph3			
	T27			

**4800**

**10'lu Bits Set**  
*Bit Set (10 Pcs)*



KOD CODE	İÇERİK CONTENTS	g		TL/Ad.
4800 00 8110	0.6x4.5 - 0.8x5.5 1.2x6.5	55	10	29,25
	Ph1 - Ph2 - Ph3			
	T25 - T27 - T30 - T40			

**4800**

**31'li Bits Takım (Plastik Kutulu)**  
*Bit Set In Plastic Case (31 Pcs)*

**YENİ NEW**



KOD CODE	İÇERİK CONTENTS	g		TL/Ad.
4800 00 8131	0.6x4.5 - 0.8x5.5	385	6 - 6	93,65
	1.2x6.5			
	Ph1			
	Ph2 - Ph3			
	T27			
	T25 - T30 - T40			
	6.3 x 60 Adaptör			

## 4810-4860

### Düz Bits Uçlar

Bits Flat

25mm-50mm-75mm-100mm-150mm



YENİ  
NEW



Krom vanadyum  
Chrom vanadium

## 4820-4870

### Yıldız Bits Uçlar

Bits Phillips

25mm-50mm-75mm-100mm-150mm



YENİ  
NEW



Krom vanadyum  
Chrom vanadium

6

KOD CODE	⊖	L mm	g	□	TL/Ad.
4810 20 0645	0.6x4.5	25	5	10	2,25
4810 20 0855	0.8x5.5	25	5	10	2,25
4810 20 1265	1.2x6.5	25	5	10	2,25
4810 20 5645	0.6x4.5	50	10	10	3,60
4810 20 5855	0.8x5.5	50	10	10	3,60
4810 20 5265	1.2x6.5	50	10	10	3,60
4860 20 0745	4.5	75	11	10	5,55
4860 20 0755	5.5	75	13	10	5,55
4860 20 0765	6.5	75	15	10	5,55
4860 20 1045	4.5	100	14	10	8,30
4860 20 1055	5.5	100	17	10	8,30
4860 20 1065	6.5	100	18	10	8,30
4860 20 1545	4.5	150	21	10	12,00
4860 20 1555	5.5	150	26	10	12,00
4860 20 1565	6.5	150	28	10	12,00

KOD CODE	⊕	L mm	g	□	TL/Ad.
4820 21 0001	Ph1	25	5	10	2,50
4820 21 0002	Ph2	25	5	10	2,50
4820 21 0003	Ph3	25	5	10	2,50
4820 21 0011	Ph1	50	10	10	3,75
4820 21 0012	Ph2	50	10	10	3,75
4820 21 0013	Ph3	50	10	10	3,75
4870 21 0701	Ph1	75	17	10	5,65
4870 21 0702	Ph2	75	18	10	5,65
4870 21 0703	Ph3	75	18	10	5,65
4870 21 1001	Ph1	100	20	10	8,65
4870 21 1002	Ph2	100	24	10	8,65
4870 21 1003	Ph3	100	24	10	8,65
4870 21 1501	Ph1	150	23	10	12,30
4870 21 1502	Ph2	150	33	10	12,30
4870 21 1503	Ph3	150	33	10	12,30

## 4810

### Düz Bits Set (25 mm)

Flat Bit Set (25 mm)



KOD CODE	⊖	g	□	TL/Ad.
4810 00 0645	06x4.5	45	10	23,00
4810 00 0855	0.8x5.5	50	10	23,00
4810 00 1265	1.2x6.5	55	10	23,00

## 4820

### Yıldız Bits Set (25 mm)

Phillips Bit Set (25 mm)



KOD CODE	⊕	g	□	TL/Ad.
4820 00 0001	Ph1	50	10	25,00
4820 00 0002	Ph2	50	10	25,00
4820 00 0003	Ph3	55	10	25,00

## 4825-4880

### Pozidriv Bits Uçlar

Bits Pozidriv

25mm-50mm-75mm-100mm-150mm



Krom vanadyum  
Chrom vanadium

KOD CODE	+	L mm	g	TL/Ad.	
4825 21 0001	Pz1	25	5	10	2,65
4825 21 0002	Pz2	25	5	10	2,65
4825 21 0003	Pz3	25	5	10	2,65
4825 21 0011	Pz1	50	10	10	3,90
4825 21 0012	Pz2	50	10	10	3,90
4825 21 0013	Pz3	50	10	10	3,90
4880 21 0701	Pz1	75	17	10	5,75
4880 21 0702	Pz2	75	18	10	5,75
4880 21 0703	Pz3	75	18	10	5,75
4880 21 1001	Pz1	100	20	10	8,75
4880 21 1002	Pz2	100	24	10	8,75
4880 21 1003	Pz3	100	24	10	8,75
4880 21 1501	Pz1	150	23	10	12,50
4880 21 1502	Pz2	150	33	10	12,50
4880 21 1503	Pz3	150	33	10	12,50

## 4830-4885

### Torx® Bits Uçlar

Bits Torx®

25mm-50mm-75mm-100mm-150mm



Krom vanadyum  
Chrom vanadium

KOD CODE	+	L mm	g	TL/Ad.	
4830 21 0025	T25	25	5	10	3,75
4830 21 0027	T27	25	5	10	3,75
4830 21 0030	T30	25	5	10	3,75
4830 21 0040	T40	25	5	10	3,75
4830 21 0125	T25	50	10	10	4,70
4830 21 0127	T27	50	10	10	4,70
4830 21 0130	T30	50	10	10	4,70
4830 21 0140	T40	50	10	10	4,70
4885 21 0725	T25	75	12	10	6,15
4885 21 0727	T27	75	15	10	6,15
4885 21 0730	T30	75	15	10	6,15
4885 21 0740	T40	75	17	10	6,15
4885 21 1025	T25	100	15	10	8,90
4885 21 1027	T27	100	20	10	8,90
4885 21 1030	T30	100	20	10	8,90
4885 21 1040	T40	100	23	10	8,90
4885 21 1525	T25	150	20	10	12,75
4885 21 1527	T27	150	25	10	12,75
4885 21 1530	T30	150	25	10	12,75
4885 21 1540	T40	150	33	10	12,75

6

## 4825

### Pozidriv Bits Set (25 mm)

Pozidriv Bit Set (25 mm)



KOD CODE	+	g	TL/Ad.	
4825 00 0001	Pz1	50	10	26,50
4825 00 0002	Pz2	55	10	26,50
4825 00 0003	Pz3	55	10	26,50

## 4830

### Torx® Bits Set (25 mm)

Torx® Bit Set (25 mm)



KOD CODE	+	g	TL/Ad.	
4830 00 0025	T25	50	10	38,00
4830 00 0027	T27	50	10	38,00
4830 00 0030	T30	55	10	38,00
4830 00 0040	T40	60	10	38,00

4850

75mm Uzun Bits Uç Takımı (13 Parça)  
Bit Set, Long Type 75 mm (13 Pcs)

75mm

YENİ  
NEW



KOD CODE	İÇERİK CONTENTS	g	TL/Ad.
4850 00 0713	<b>Düz Uçlar</b> Flat Bits 4.5 - 5.5 - 6.5	204	13
	<b>Yıldız Uçlar</b> Phillips Bits Ph1 - Ph2 - Ph3		
	<b>Pozidriv Uçlar</b> Pozidriv Bits Pz1 - Pz2 - Pz3		
	<b>Torx® Uçlar</b> Torx® Bits T25 - T27 T30 - T40		
			78,30

6

4850

150mm Uzun Bits Uç Takımı (13 Parça)  
Bit Set, Long Type 150 mm (13 Pcs)

150mm

YENİ  
NEW



KOD CODE	İÇERİK CONTENTS	g	TL/Ad.
4850 00 1513	<b>Düz Uçlar</b> Flat Bits 4.5 - 5.5 - 6.5	356	13
	<b>Yıldız Uçlar</b> Phillips Bits Ph1 - Ph2 - Ph3		
	<b>Pozidriv Uçlar</b> Pozidriv Bits Pz1 - Pz2 - Pz3		
	<b>Torx® Uçlar</b> Torx® Bits T25 - T27 - T30 - T40		
			161,40

4850

100mm Uzun Bits Uç Takımı (13 Parça)  
Bit Set, Long Type 100 mm (13 Pcs)

100mm

YENİ  
NEW



KOD CODE	İÇERİK CONTENTS	g	TL/Ad.
4850 00 1013	<b>Düz Uçlar</b> Flat Bits 4.5 - 5.5 - 6.5	263	13
	<b>Yıldız Uçlar</b> Phillips Bits Ph1 - Ph2 - Ph3		
	<b>Pozidriv Uçlar</b> Pozidriv Bits Pz1 - Pz2 - Pz3		
	<b>Torx® Uçlar</b> Torx® Bits T25 - T27 - T30 - T40		
			112,70



## 4900

### Allen Anahtar Altı Köşe (mm) Hex Key Wrench (mm)

TS ISO 2936  
DIN ISO 2936

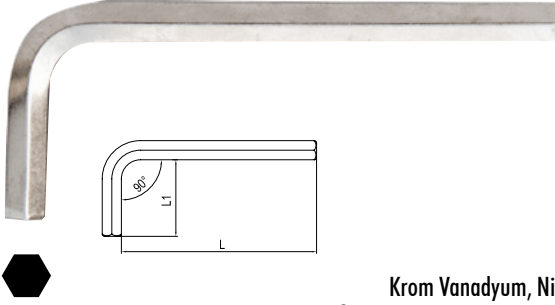

Krom Vanadyum, Nikel Kaplı  
Chrom Vanadium, Nickel Plated

KOD CODE	mm	L mm	L1 mm	g	TL/Ad.	
4900 22 0015	1.5	45	14	1.5	10	1,50
4900 22 0020	2	50	16	2	10	1,75
4900 22 0025	2.5	56	18	4	10	2,15
4900 22 0030	3	63	20	6	10	2,40
4900 22 0035	3.5	66	22	8	10	2,95
4900 22 0040	4	70	25	10	10	3,05
4900 22 0050	5	80	28	20	10	3,55
4900 22 0060	6	90	32	30	10	4,70
4900 22 0070	7	95	34	40	10	7,00
4900 22 0080	8	100	36	55	10	7,35
4900 22 0090	9	105	38	75	10	9,10
4900 22 0100	10	112	40	100	10	11,25
4900 22 0120	12	125	45	160	10	14,30
4900 22 0140	14	140	56	250	5	24,60
4900 22 0160	16	152	60	375	5	39,90
4900 22 0170	17	160	63	425	5	43,30
4900 22 0190	19	180	70	610	5	56,70
4900 22 0220	22	200	80	940	5	94,55
4900 22 0240	24	224	90	1250	5	127,75

## 4900

### Allen Anahtar Takım Altı Köşe (mm) Hex Key Wrench Set (mm)

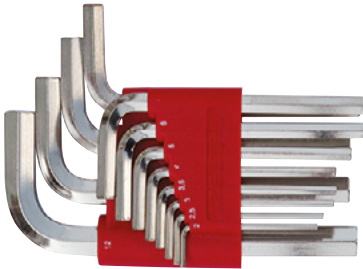

KOD CODE	İÇERİK CONTENTS	g	TL/Ad.	
4900 00 3110	2 - 2.5 - 3 - 4 - 5 - 6 7 - 8 - 9 - 10	400	10	52,30
4900 00 3112	2 - 2.5 - 3 - 3.5 - 4 - 5 6 - 7 - 8 - 9 - 10 - 12	565	12	69,55

## 4901

### Allen Anahtar Altı Köşe (SAE) Hex Key Wrench (SAE)

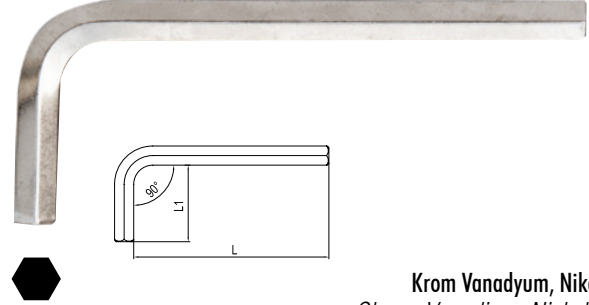

Krom Vanadyum, Nikel Kaplı  
Chrom Vanadium, Nickel Plated

KOD CODE	inch	L mm	L1 mm	g	TL/Ad.	
4901 22 1984	5/64"	50	16	2	10	2,60
4901 22 2381	3/32"	54	18	4	10	2,85
4901 22 3125	1/8"	58	20	5	10	3,50
4901 22 3968	5/32"	62	22	10	10	4,25
4901 22 4762	3/16"	68	24	15	10	4,40
4901 22 5556	7/32"	74	26	25	10	5,90
4901 22 6350	1/4"	82	28	35	10	7,20
4901 22 7937	5/16"	94	32	55	10	8,95
4901 22 9825	3/8"	106	38	90	10	12,45
4901 22 1111	7/16"	118	42	130	10	16,75
4901 22 1270	1/2"	132	46	190	10	19,20
4901 22 1428	9/16"	144	52	265	10	28,05
4901 22 1587	5/8"	156	58	365	10	43,70
4901 22 1905	3/4"	176	66	600	5	61,15

## 4901

### Allen Anahtar Takım Altı Köşe (SAE) Hex Key Wrench Set (SAE)

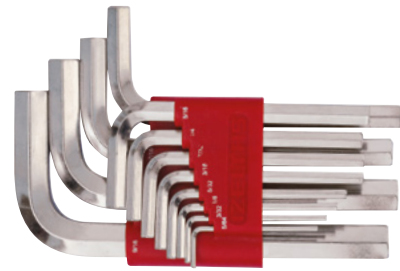

KOD CODE	İÇERİK CONTENTS	g	TL/Ad.	
4901 00 3110	5/64" - 3/32" - 1/8" - 5/32" 3/16" - 7/32" - 1/4" - 5/16" 3/8" - 7/16"	405	10	68,85
4901 00 3112	5/64" - 3/32" - 1/8" - 5/32" 3/16" - 7/32" - 1/4" - 5/16" 3/8" - 7/16" - 1/2" - 9/16"	855	12	116,10

4903

Allen Anahtar Altı Köşe Uzun Boy (mm)  
Hex Key Wrench Long Pattern (mm)

TS ISO 2936  
DIN ISO 2936

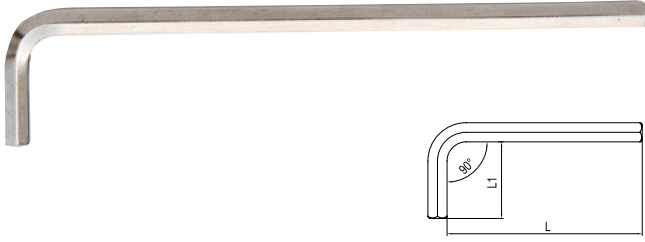

Krom Vanadyum, Nikel Kaplı  
Chrom Vanadium, Nickel Plated

KOD CODE	mm	L mm	L1 mm	g	TL/Ad.	
4903 22 0020	2	100	16	3	10	2,95
4903 22 0025	2.5	112	18	5	10	3,55
4903 22 0030	3	126	20	10	10	4,05
4903 22 0035	3.5	136.5	22	15	10	5,00
4903 22 0040	4	140	25	20	10	5,10
4903 22 0050	5	160	28	30	10	5,35
4903 22 0060	6	180	32	50	10	8,75
4903 22 0070	7	190	34	80	10	13,00
4903 22 0080	8	200	36	100	10	13,65
4903 22 0090	9	210	38	145	10	16,85
4903 22 0100	10	224	40	180	10	20,90
4903 22 0120	12	250	45	285	10	26,50
4903 22 0140	14	280	56	460	5	45,75
4903 22 0160	16	300	60	625	5	74,10
4903 22 0170	17	320	63	750	5	80,70
4903 22 0190	19	360	70	1100	5	119,60

6

4905

Yuvarlak Başlı Allen Anahtar (mm)  
Hex Key Wrench Ballpoint (mm)



Krom Vanadyum, Nikel Kaplı  
Chrom Vanadium, Nickel Plated

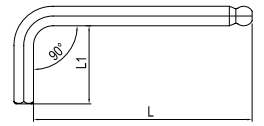

KOD CODE	mm	L mm	L1 mm	g	TL/Ad.	
4905 22 0020	2	50	16	3	10	3,10
4905 22 0025	2.5	56	18	4	10	3,75
4905 22 0030	3	63	20	5	10	4,25
4905 22 0040	4	70	25	10	10	5,35
4905 22 0050	5	80	28	20	10	5,60
4905 22 0060	6	90	32	30	10	8,40
4905 22 0080	8	100	36	55	10	13,00
4905 22 0100	10	112	40	100	10	20,00

4903

Allen Anahtar Takım Altı Köşe Uzun Boy (mm)  
Hex Key Wrench Set Long Pattern (mm)

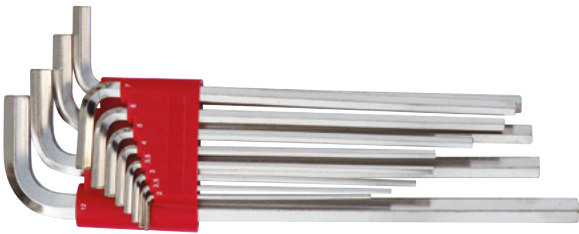

KOD CODE	İÇERİK CONTENTS	g	TL/Ad.
4903 00 3110	2 - 2.5 - 3 - 4 - 5 - 6 7 - 8 - 9 - 10	660	10
4903 00 3112	2 - 2.5 - 3 - 3.5 - 4 - 5 6 - 7 - 8 - 9 - 10 - 12	940	12

4905

Yuvarlak Başlı Allen Anahtar Takımı (8 Parça, mm)  
Hex Key Wrench Ballpoint Set (8 Pcs, mm)



KOD CODE	İÇERİK CONTENTS	g	TL/Ad.
4905 00 7108	2 - 2.5 - 3 - 4 5 - 6 - 8 - 10	275	8



## 4906

Yuvarlak Başlı Allen Anahtar Uzun Boy (mm)  
Hex Key Wrench Ballpoint Long Pattern (mm)

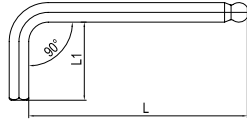

Krom Vanadyum, Nikel Kaplı  
Chrom Vanadium, Nickel Plated

KOD CODE	mm	L mm	L1 mm	g	TL/Ad.	
4906 22 0015	1.5	79	12	1.5	10	4,15
4906 22 0020	2	84	16	3	10	5,55
4906 22 0025	2.5	89	16	5	10	6,00
4906 22 0030	3	99	18	7	10	6,55
4906 22 0040	4	109	23	13	10	7,45
4906 22 0050	5	125	26	25	10	9,40
4906 22 0060	6	150	28	42	10	10,80
4906 22 0080	8	167	33	85	10	16,05
4906 22 0100	10	190	37	150	10	23,05

## 4910

Torx® Allen Anahtar  
Torx® Key Wrench

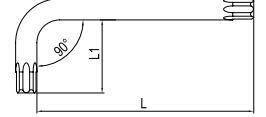
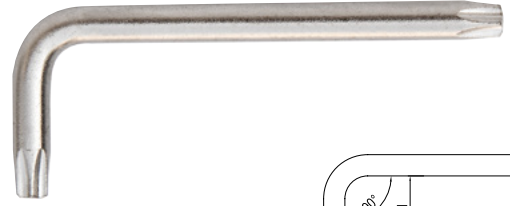

Krom Vanadyum, Nikel Kaplı  
Chrom Vanadium, Nickel Plated

KOD CODE	☆	L mm	L1 mm	g	TL/Ad.	
4910 22 0006	T6	42	16	2	10	11,35
4910 22 0007	T7	48	16	2	10	11,35
4910 22 0008	T8	48	16	3	10	11,35
4910 22 0009	T9	48	16	3	10	11,45
4910 22 0010	T10	51	17	4	10	11,45
4910 22 0015	T15	54	18	5	10	11,80
4910 22 0020	T20	57	19	5	10	12,35
4910 22 0025	T25	60	20	10	10	12,35
4910 22 0027	T27	64	21	15	10	12,35
4910 22 0030	T30	70	24	20	10	13,25
4910 22 0040	T40	76	26	30	10	14,10
4910 22 0045	T45	83	29	40	10	17,30
4910 22 0050	T50	95	32	60	10	19,70
4910 22 0055	T55	108	35	125	10	27,45
4910 22 0060	T60	120	38	185	10	37,85

6

## 4906

Yuvarlak Başlı Allen Anahtar Takım Altı Köşe Uzun Boy (9 parça, mm)  
Hex Key Wrench Ballpoint Long Pattern Set (9 Pcs, mm)



KOD CODE	İÇERİK CONTENTS	g	TL/Ad.	
4906 00 3109	1.5 - 2 - 2.5 - 3 - 4 - 5 - 6 8 - 10	355	9	89,00

## 4910

Torx® Allen Anahtar Takımı (8 Parça)  
Torx® Key Wrench Set (8 Pcs)



KOD CODE	İÇERİK CONTENTS	g	TL/Ad.	
4910 00 7108	T9 - T10 - T15 T20 - T25 - T27 T30 - T40	155	8	99,10

4912

Kaset Allen Anahtar Takımı (7 Parça, mm)  
Hex Key Wrench Folding Set (7 Pcs, mm)



Krom vanadyumu  
Chrom vanadium

KOD CODE	İÇERİK CONTENTS	g	TL/Ad.
4912 00 3107	2.5 - 3 - 4 - 5 - 6 - 8 - 10	355	89,15
4912 00 0007	1.5 - 2 - 2.5 - 3 - 4 - 5 - 6	130	66,00

4909

T Tipi Torx Allen Anahtar  
T Handle Torx Key Wrench



Krom vanadyum, Nikel kaplı, PP saplı  
Chrom vanadium, Nickel plated, PP handle

KOD CODE	☆	L1 mm	L2 mm	g	TL/Ad.
4909 22 0009	T9	125	15	22	5 27,35
4909 22 0010	T10	125	15	22	5 27,90
4909 22 0015	T15	125	15	26	5 28,45
4909 22 0020	T20	125	15	44	5 28,70
4909 22 0025	T25	150	20	49	5 29,35
4909 22 0027	T27	150	20	62	5 32,60
4909 22 0030	T30	150	20	82	5 33,55
4909 22 0040	T40	175	25	100	5 34,80

4909

T Tipi Torx Allen Anahtar Takımı (8 Parça)  
T Handle Torx Key Wrench Set (8 Pcs)



KOD CODE	İÇERİK CONTENTS	g	TL/Ad.
4909 00 8108	T9 - T10 - T15 - T20 T25 - T27 - T30 - T40	407	8 242,70



**4920**

**T Tipi Allen Anahtar (mm)**  
Hex Key Wrench T - Handle (mm)

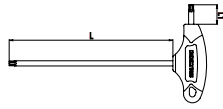

**Krom Vanadyum**  
Chrom Vanadium



KOD CODE	mm	L mm	L1 mm	g	TL/Ad.	
4920 22 0025	2.5	110	14	20	5	16,85
4920 22 0030	3	125	17	23	5	17,15
4920 22 0040	4	140	20	45	5	19,25
4920 22 0050	5	155	23	58	5	20,55
4920 22 0060	6	170	26	100	5	23,50
4920 22 0070	7	185	30	125	5	24,70
4920 22 0080	8	200	34	150	5	27,55
4920 22 0100	10	220	40	240	5	44,00

**4921**

**Yuvarlak Başlı T Tipi Allen Anahtar (mm)**  
Hex Key Wrench T - Handle Ballpoint (mm)

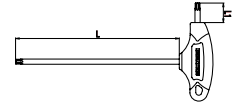
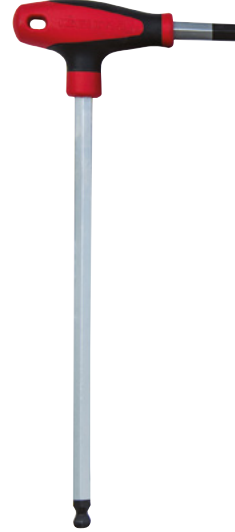

**Krom Vanadyum**  
Chrom Vanadium



KOD CODE	mm	L mm	L1 mm	g	TL/Ad.	
4921 22 0025	2.5	110	14	20	5	21,85
4921 22 0030	3	125	17	23	5	22,15
4921 22 0040	4	140	20	45	5	24,95
4921 22 0050	5	155	23	58	5	26,75
4921 22 0060	6	170	26	100	5	30,55
4921 22 0070	7	185	30	125	5	32,05
4921 22 0080	8	200	34	150	5	34,45
4921 22 0100	10	220	40	235	5	57,15

6

**4920**

**T Tipi Allen Anahtar Takımı (8 Parça, mm)**  
Hex Key Wrench T - Handle Set (8 Pcs, mm)

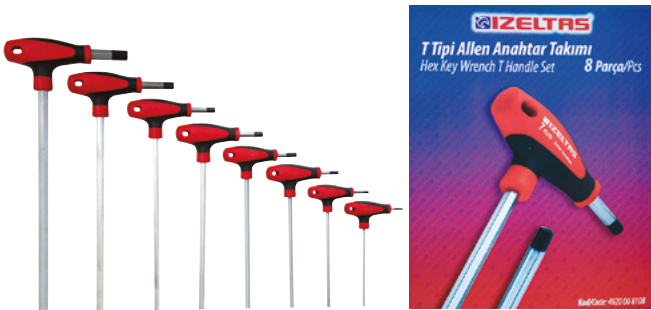

KOD CODE	İÇERİK CONTENTS	g	TL/Ad.	
4920 00 8108	2.5 - 3 - 4 - 5 6 - 7 - 8 - 10	760	8	193,55

**4921**

**Yuvarlak Başlı T Tipi Allen Anahtar Takımı (8 Parça, mm)**  
Hex Key Wrench T - Handle Ballpoint Set (8 Pcs, mm)



KOD CODE	İÇERİK CONTENTS	g	TL/Ad.	
4921 00 8108	2.5 - 3 - 4 5 - 6 - 7 - 8 - 10	755	8	249,90



ZELTRIS  
EST. 1988



# 7

## Keskiler ve Çekiçler Chisels and Hammers



*Keskiler* Chisels  
*Zimbalar* Punches  
*Çekiçler* Hammers  
*Keserler* Adzes

5010

Iskarpela (Düz)  
Wood Chisel

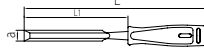

Özel alaşımli çelik, Uç indüksiyonda sertleştirilmiş, PP Saplı  
Special steel, Induction hardened tips, PP Handle

KOD CODE	a mm	L mm	L1 mm	g	TL/Ad.	
5010 23 0006	6	273	153	115	5	32,50
5010 23 0008	8	273	153	125	5	34,80
5010 23 0010	10	273	153	135	5	36,75
5010 23 0012	12	273	153	135	5	40,35
5010 23 0014	14	273	153	145	5	41,75
5010 23 0016	16	273	153	150	5	44,65
5010 23 0018	18	273	153	160	5	48,45
5010 23 0020	20	273	153	170	5	53,85
5010 23 0022	22	273	153	190	5	58,35
5010 23 0024	24	273	153	195	5	63,05
5010 23 0026	26	273	153	200	5	65,35
5010 23 0028	28	273	153	200	5	67,55
5010 23 0030	30	275	155	205	5	69,75

7

5010

Iskarpela Takım (6 parça)  
Wood Chisel Set (6 Pcs)



KOD CODE	İÇERİK CONTENTS	g	TL/Ad.	
5010 00 8106	10 - 12 - 14 16 - 18 - 20	985	6	265,80

5500

Düz Keski  
Flat Cold Chisel

TS 492  
DIN 6453



Özel alaşımli çelik, Krom kaplı  
Special steel, Chrom plated

KOD CODE	L mm	a mm	g	TL/Ad.	
5500 23 0100	100	17	75	5	18,75
5500 23 0125	125	19	110	5	22,60
5500 23 0150	150	21	180	5	29,10
5500 23 0175	175	24	245	5	32,85
5500 23 0200	200	27	340	5	45,75
5500 23 0250	250	30	525	5	56,25
5500 23 0300	300	30	635	5	90,20

5500

Düz Keski (Kalkan İzoleli)  
Flat Cold Chisel (With Safety Handle)

TS 492  
DIN 6453

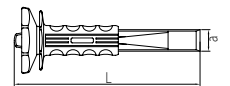

Özel alaşımli çelik, Krom kaplı  
Special steel, Chrom plated

KOD CODE	L mm	a mm	g	TL/Ad.	
5500 23 1250	250	30	700	1	75,00
5500 23 1300	300	30	790	1	109,45

## 5510

Tesviyeci Düz Keski  
Flat Cold Chisel Octagonal

TS 492  
DIN 6453

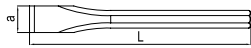

Krom vanadyum, Krom kaplı  
Chrom vanadium, Chrom plated

KOD CODE	L mm	a mm	g	TL/Ad.
5510 23 0125	125	10	75	25,80
5510 23 0150	150	14	125	32,20

## 5520

Tırnak Keski  
Cross Cut Chisel

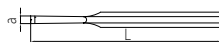

Krom vanadyum, Krom kaplı  
Chrom vanadium, Chrom plated

KOD CODE	L mm	a mm	g	TL/Ad.
5520 23 0125	130	5	70	28,90
5520 23 0150	150	6	110	31,30

## 5540

Nokta Zimba  
Center Punch

DIN 7250

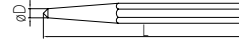

Krom vanadyum, Elektrostatik boyanmış  
Chrom vanadium, Electrostatically painted

KOD CODE	L mm	L inch	øD mm	g	TL/Ad.	
5540 24 4120	120	4 3/4"	4	65	10	18,45
5540 24 5120	120	4 3/4"	5	95	10	20,70
5540 24 5150	150	6"	5	115	10	22,00
5540 24 0412	120	4 3/4"	4	65	10	17,60

## 5545

Konik Pim Zimba  
Drift Punch

DIN 6458

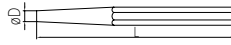

Krom vanadyum, Elektrostatik boyanmış  
Chrom vanadium, Electrostatically painted

KOD CODE	L mm	L inch	øD mm	g	TL/Ad.	
5545 24 0002	120	4 3/4"	2	90	10	17,75
5545 24 0003	120	4 3/4"	3	90	10	19,25
5545 24 0004	120	4 3/4"	4	90	10	21,70
5545 24 0005	120	4 3/4"	5	95	10	22,15
5545 24 0006	120	4 3/4"	6	95	10	32,70
5545 24 0007	120	6"	7	100	10	34,05
5545 24 0008	150	6"	8	125	10	35,40
5545 24 0009	150	6"	9	130	10	36,20
5545 24 0010	150	6"	10	130	10	36,95
5545 24 0012	150	6"	12	180	10	38,60
5545 24 0103	120	4 3/4"	3	90	10	20,15

## 5550

Düz Pim Zimba  
Split Pin Punch

DIN 6450

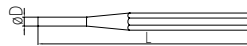

Krom vanadyum, Elektrostatik boyanmış  
Chrom vanadium, Electrostatically painted

KOD CODE	L mm	L inch	øD mm	g	TL/Ad.	
5550 24 0002	150	6"	2	70	5	22,05
5550 24 0003	150	6"	3	65	5	22,35
5550 24 0004	150	6"	4	65	5	22,35
5550 24 0005	150	6"	5	65	5	22,40
5550 24 0006	150	6"	6	70	5	24,30
5550 24 0007	150	6"	7	100	5	25,35
5550 24 0008	150	6"	8	105	5	27,10
5550 24 0009	150	6"	9	110	5	27,50
5550 24 0010	150	6"	10	120	5	27,75
5550 24 0105	150	6"	5	65	5	22,70

5550

Düz Pim Zımba Takımı (6 Parça)  
Split Pin Punch (6 Pcs)



KOD CODE	İÇERİK CONTENTS	g	TL/Ad.
5550 00 1006	3 - 4 - 5 - 6 - 7 - 8	865	6 143,85

5600

Keski Zımba Takımı  
Chisel And Punch Set



KOD CODE	İÇERİK CONTENTS	g	TL/Ad.
5600 00 6106	<b>125 tevsiyeci düz keski</b> 125 Flat Cold Chisel Octagonal	865	6 147,35
	<b>150 tevsiyeci düz keski</b> 150 Flat Cold Chisel Octagonal		
	<b>125 tırnak keski</b> 125 Cross Cut Chisel		
	<b>4x120 nokta zımba</b> 4x120 Center Punch		
	<b>5x150 düz pim zımba</b> 5x150 Split PinPunch		
	<b>3x120 konik pim zımba</b> 3x120 Drift Punch		

5700

Kayış Zımba  
Belt Punch

DIN 7200

TSEK



Krom vanadyum, Elektrostatik boyanmış  
Chrom vanadium, Electrostatically painted

KOD CODE	ØD mm	L mm	g	TL/Ad.
5700 24 0003	3	105	35	10 15,90
5700 24 0004	4	105	40	10 16,65
5700 24 0005	5	110	50	10 18,10
5700 24 0006	6	110	60	10 18,40
5700 24 0007	7	115	75	10 20,30
5700 24 0008	8	115	90	10 21,60
5700 24 0009	9	120	100	10 24,10
5700 24 0010	10	120	110	10 25,65
5700 24 0011	11	125	130	5 27,60
5700 24 0012	12	125	165	5 33,05
5700 24 0013	13	130	165	5 34,80
5700 24 0014	14	130	180	5 38,25
5700 24 0015	15	135	245	5 43,85
5700 24 0016	16	135	300	5 48,05
5700 24 0017	17	140	365	5 52,55
5700 24 0018	18	140	380	5 57,35
5700 24 0019	19	145	405	5 62,35
5700 24 0020	20	145	450	5 66,40

5700

Kayış Zımba Takımı  
Belt Punch Set



KOD CODE	İÇERİK CONTENTS	g	TL/Ad.
5700 00 2110	3 - 4 - 5 - 6 - 7 8 - 9 - 10 - 11 - 12	845	10 221,35
5700 00 2112	3 - 4 - 5 - 6 - 7 - 8 - 9 10 - 11 - 12 - 13 - 14	1180	12 294,40



## 5800

Tesviyeci Çekiç  
Machinist Hammer

TS 5  
DIN 1041  
TSE



Yedek parça sayfa 165  
Spare parts page 165

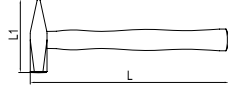

Özel alaşımlı çelik, İndüksiyonda sertleştirilmiş, Elektrostatik boyanmış  
Special steel, Induction hardened, Electrostatically painted

KOD CODE	L mm	L1 mm	g	g	TL/Ad.
5800 25 0100	260	82	100	160	10 26,85
5800 25 0200	280	95	200	260	10 36,20
5800 25 0300	300	105	300	395	10 44,15
5800 25 0500	320	118	500	600	5 55,80
5800 25 1000	360	135	1000	1095	5 85,65
5800 25 1500	380	145	1500	1630	5 116,50
5800 25 2000	400	155	2000	2100	5 143,30

## 5850

Plastik Çekiç  
Plastic Hammer

TS 5  
TSE



Yedek parça sayfa 164  
Spare parts page 164

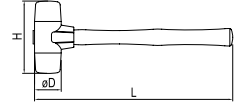

Darbeye dayanıklı, Kolay değiştirilebilir başlık  
Durable and easily changeable heads

KOD CODE	L mm	øD mm	H mm	g	TL/Ad.
5850 25 0030	300	30	100	345	5 54,30
5850 25 0040	320	40	110	645	5 66,10
5850 25 0050	350	50	120	1015	5 82,60

## 5810

Emniyet Çekici  
Safety Hammer

TS 5

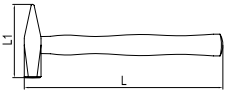

Özel alaşımlı çelik, İndüksiyonda sertleştirilmiş, Elektrostatik boyanmış  
Special steel, Induction hardened, Electrostatically painted

KOD CODE	L mm	L1 mm	g	g	TL/Ad.
5810 25 1000	260	135	1000	1095	5 115,65
5810 25 1500	280	145	1500	1630	5 160,05
5810 25 2000	400	155	2000	2100	5 197,75

### Emniyet çekici

Çekiç kafası ile sapın birleşiminde yuvarlak kama ve yapışkan malzeme kullanılarak sağlamlığı artırılmış ayrıca birleşimi çelik sac malzeme ile desteklenerek güvenli kullanım sağlanmıştır.

### Safety Hammer

Connection between the hammer head and the handle is ensured by circular wedge and epoxy glue, while it is also reinforced by sheet metal for safe use.

## 5870

Lastik Çekiç  
Rubber Hammer

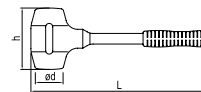

KOD CODE	L mm	ød mm	h mm	g	g	TL/Ad.
5870 25 0400	300	47	104	400	610	5 101,05

5865

Madırğa  
Mallet

TS 5

YENİ  
NEW

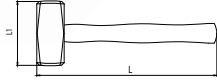

Yedek parça sayfa 165  
Spare parts page 165

Özel alaşımli çelik  
Special steel

KOD CODE	L mm	L1 mm	g	g	TL/Ad.
5865 25 1000	260	95	1000	1210	1 105,90
5865 25 1500	280	110	1500	1770	1 126,65

7

6410

Nacak  
Hatchet

YENİ  
NEW

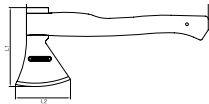

Yedek parça sayfa 165  
Spare parts page 165

Özel alaşımli çelik, İndüksiyonda sertleştirilmiş, Elektrostatik boyanmış  
Special steel, Induction hardened, Electrostatically painted

KOD CODE	L mm	L1 mm	L2 mm	g	g	TL/Ad.
6410 25 0800	380	165	115	800	1065	1 141,60

6400

Keser  
Adze

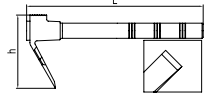

Yedek parça sayfa 164  
Spare parts page 164

Özel alaşımli çelik, İndüksiyonda sertleştirilmiş,  
Elektrostatik boyanmış, PVC ağız koruyucu  
Special steel, Induction hardened, Electrostatically painted,  
PVC cutting edge protector

KOD CODE	L mm	h mm	g	g	TL/Ad.
6400 25 0600	400	125	400	550	5 101,15

6401

Usta Keseri  
Master Adze

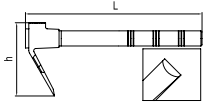

Yedek parça sayfa 164  
Spare parts page 164

Özel alaşımli çelik, İndüksiyonda sertleştirilmiş,  
Elektrostatik boyanmış, PVC ağız koruyucu  
Special steel, Induction hardened, Electrostatically painted,  
PVC cutting edge protector

KOD CODE	L mm	h mm	g	g	TL/Ad.
6401 25 0600	400	125	400	540	5 101,15

# 8

## Servis Alet ve Ekipmanları Maintenance Tools and Equipment



<i>Servis Aletleri</i>	<i>Service Equipment</i>
<i>Perçin Tabancası</i>	<i>Riveting Pliers</i>
<i>İşkenceler</i>	<i>Clamps</i>
<i>İnşaat Ekipmanları</i>	<i>Construction Equipment</i>
<i>Metreler</i>	<i>Measuring Tapes</i>
<i>Mengene</i>	<i>Forged Steel Vice</i>
<i>Su Terazisi</i>	<i>Straight Level</i>
<i>Gres Pompası</i>	<i>Grease Gun</i>

03750

Kablo Sıyrıcı  
Wire Stripper



Yedek parça sayfa 165  
Spare parts page 165

KOD CODE	ÖLÇÜ SIZE	g	TL/Ad.
03750 50 020	Ø8-28	79	5 66,50

03752

Kablo Sıyrıcı  
Cable Stripper



8

Yedek parça sayfa 165  
Spare parts page 165

KOD CODE	ÖLÇÜ SIZE	g	TL/Ad.
03752 50 625	Tek 6/300 Çok 1.5/25	70	5 60,45

03751

Koaksiyel Kablo Sıyrıcı  
Coaxial Cable Stripper



KOD CODE	ÖLÇÜ SIZE	g	TL/Ad.
03751 50 012	Dış (1) İç (2)	20	5 86,30

03753

Mekanik Kablo Sıyrıcı  
Mechanical Cable Stripper



KOD CODE	ÖLÇÜ SIZE	g	TL/Ad.
03753 50 054	0.5/4	100	5 113,75

05881

Plastik, Krom Şerit Metre  
Plastic, Chrom Steel Case, Measuring tapes



KOD CODE	ÖLÇÜ SIZE M	g	MODEL	TL/Ad.
05881 50 003	3	145	Plastik/Plastic	5 26,15
05881 50 005	5	200	Plastik/Plastic	5 31,40
05881 50 013	3	160	Krom/Chrom	5 31,20
05881 50 015	5	220	Krom/Chrom	5 35,20

**05886**

**Arazi Tipi Fibreglas Şerit Metre (Saplı)**  
*Fiberglass Measuring Tape Field Type (With Holder)*



KOD CODE	ÖLÇÜ SIZE M	g		TL/Ad.
05886 50 020	20	520	1	69,80
05886 50 030	30	585	1	74,55
05886 50 050	50	820	1	119,80

**05880**

**Su terazisi**  
*Straight Level*



**Alüminyum gövde**  
*Aluminum body*

KOD CODE	L mm	g		TL/Ad.
05880 50 040	400	250	5	64,00
05880 50 050	500	300	5	69,50
05880 50 060	600	350	5	75,45
05880 50 070	700	400	5	81,10
05880 50 080	800	450	5	87,55
05880 50 100	1000	500	5	99,70
05880 50 120	1200	550	5	118,00
05880 50 150	1500	600	5	136,00
05880 50 200	2000	800	5	190,00

**05887**

**Kumpas**  
*Vernier*



**Sürgülü, Stoplu**  
*Sliding and with stop*

KOD CODE	L mm	g		TL/Ad.
05887 50 150	150	155	5	226,15

**05890**

**Testere Kolu**  
*Hacksaw Frame*



**Yedek parça sayfa 165**  
*Spare parts page 165*

KOD CODE	L mm	g		TL/Ad.
05890 50 830	300	540	5	94,25

**05895**

**Kıl Testere Kolu (Ağaç saplı)**  
*Hacksaw Frame (Wooden Handle)*



KOD CODE	L mm	g		TL/Ad.
05895 50 150	150	95	10	20,45

**6735**

**Dal Budama Testeresi**  
*Pruning Saw*



**Yedek parça sayfa 165**  
*Spare parts page 165*

KOD CODE	L mm	g		TL/Ad.
6735 27 0300	300	400	5	106,00

## 05901

Sentil (20 Parça, mm)  
Feeler Gauges (20 Pcs, mm)



KOD CODE	ÖLÇÜ SIZE mm	g		TL/Ad.
05901 50 020	0.05 - 1	90	10	22,85

## 05902

Sentil (20 Parça, SAE)  
Feeler Gauges (20 Pcs, SAE)



KOD CODE	ÖLÇÜ SIZE inch	g		TL/Ad.
05902 50 020	2 - 35/1000"	65	10	35,75

## 6195

Perçin Tabancası  
Riveting Pliers



KOD CODE	ÖLÇÜ SIZE	CAPACITY mm	g		TL/Ad.
6195 26 0260	260	2.5 - 3.2 - 4 - 4.8	625	1	85,95

## 6220

Spiralli Mıknatıs  
Flexible Magnet Holder

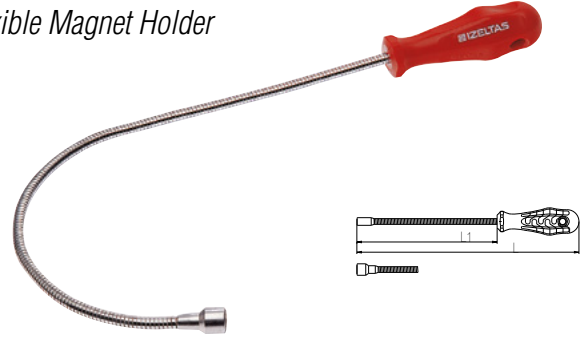

KOD CODE	ÖLÇÜ	L mm	L1 mm	g		TL/Ad.
6220 26 0500	500	465	375	100	10	65,50
6220 26 1000	1000	465	375	105	10	69,40

## 6225

Madeni Yağdanlık (Flexible Uçlu)  
Oiler With Flexible Spout



KOD CODE	ÖLÇÜ SIZE cc	g		TL/Ad.
6225 26 0200	200	170	5	40,50
6225 26 0300	300	200	5	45,55
6225 26 0500	500	225	5	50,00

## 6230

Gres Pompası  
Grease Gun



 Yedek parça sayfa 165  
Spare parts page 165

KOD CODE	ÖLÇÜ SIZE cc	g		TL/Ad.
6230 26 0300	300	1200	1	77,35
6230 26 0500	500	1320	1	90,75

**6240**

**Tapı Anahtarı (İki ağız)**  
*Offset Wrench For Carter Case*



KOD CODE	ÖLÇÜ mm	g	TL/Ad.
6240 26 0810	8x10	250	40,75

**6370**

**Yağ Filtresi Sökeceği**  
*Band Type Oil Filter Wrench*



KOD CODE	Ø mm	g	TL/Ad.
6370 26 0100	75 - 100	335	40,30

**6350**

**Levye Oluklu**  
*Tyre Lever, Straight*

TSEK



**Krom vanadyum, Krom kaplı**  
*Chrom vanadium, Chrom plated*

KOD CODE	L mm	L inch	g	TL/Ad.
6350 26 0300	300	12"	265	30,90
6350 26 0400	400	16"	440	42,35
6350 26 0500	500	20"	675	59,00
6350 26 0600	600	24"	900	72,00

**6360**

**Levye Oluklu Kıvrık Uçlu**  
*Tyre Lever, Bent*

TSEK



**Krom vanadyum, Krom kaplı**  
*Chrom vanadium, Chrom plated*

KOD CODE	L mm	L inch	g	TL/Ad.
6360 26 0600	600	24"	910	83,20

**6375**

**Çift Yönlü Üç Ayak Yağ Filtre Sökeceği**  
*Left and Right Hand Operation, Triple Leg Oil Filter Wrench*

**YENİ  
NEW**



**3/8" - 1/2"**

KOD CODE	L mm	g	TL/Ad.
6375 26 6512	65-120	375	125,25

**6380**

**Çift Zincirli Yağ Filtresi Sökeceği**  
*Oil Filter Wrench With Double Chain*

**YENİ  
NEW**



KOD CODE	L mm	g	TL/Ad.
6380 26 6016	60-160	380	378,05

**06373**

Kayırlı Yağ Filtresi Sökeceği  
Strap Wrench



KOD CODE	Ø mm	g	TL/Ad.
06373 50 140	60x140	245	5 112,35

**06374**

Zincirli Yağ Filtresi Sökeceği  
Chain Wrench



KOD CODE	Ø mm	g	TL/Ad.
06374 50 140	60x140	390	5 90,30

**06375**

Ayarlı Yağ Filtresi Sökeceği  
Adjustable Slot Type Oil Filter Wrench



 Yedek parça sayfa 165  
Spare parts page 165

KOD CODE	Ø mm	g	TL/Ad.
06375 50 100	100	215	5 44,00

**06390**

Segman Çemberi  
Piston Ring Compressor



KOD CODE	Ø mm	g	TL/Ad.
06390 50 125	125	235	5 89,40
06390 50 175	175	505	5 182,80

**07415**

Sıralı Tel Fırça (Ağaç Saplı)  
Hand Brush (Wooden Handle)



KOD CODE	ÖLÇÜ SIZE	g	TL/Ad.
07415 50 003	3 SIRA 3 RAWS	125	5 9,15
07415 50 004	4 SIRA 4 RAWS	135	5 9,70
07415 50 005	5 SIRA 5 RAWS	145	5 10,80
07415 50 006	6 SIRA 6 RAWS	170	5 11,60

**07416**

Kıvrık Uçlu Fırça (Plastik Saplı)  
Hand Brush (PP Handle)



KOD CODE	ÖLÇÜ SIZE	g	TL/Ad.
07416 50 001	270	110	5 10,40



## 07410

### Makaralı Uzatma Kablosu Extension Cord Reel



el tipi / with handle

ayaklı / with stand

KOD CODE	MODEL	ÖLÇÜ SIZE	g	TL/Ad.
07410 50 010	el tipi / with handle	10	1400	181,20
07410 50 025	ayaklı / with stand	25	4130	388,60
07410 50 050	ayaklı / with stand	50	6745	544,00

## 7400

### Dövme Çelik Mengene Forged Steel Vice

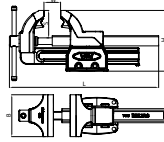
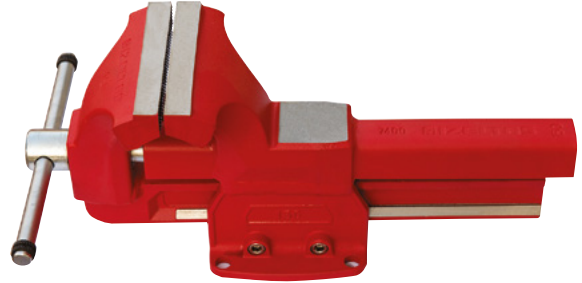

Özel alaşım çelik, Fırın boya  
Special steel, Electrostatic Paint

KOD CODE	B mm	W mm	H mm	L mm	g	TL/Ad.
7400 30 0100	100	125	148	440	5000	603,45
7400 30 0125	125	155	183	550	11000	830,80
7400 30 0150	150	180	220	675	20000	1062,55
7400 30 0175	175	205	245	760	29000	1307,40

8

## 7401

### Mengene Döner Tablası Swivel Base of Vice

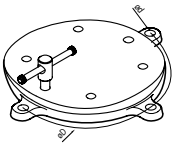

Özel alaşım çelik, Krom kaplı  
Special steel, Chrom plated

KOD CODE	ÖLÇÜ SIZE	ød mm	øD mm	g	TL/Ad.
7401 30 0100	100	10.5	170	1550	177,55
7401 30 0125	125	12.5	200	2700	234,70
7401 30 0150	150	12.5	240	3800	284,95
7401 30 0175	175	12.5	280	6650	322,10

## 7400

### Dövme Çelik Mengene (Döner Tabla dahil) Forged Steel Vice with Swivel Base

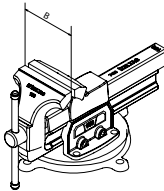
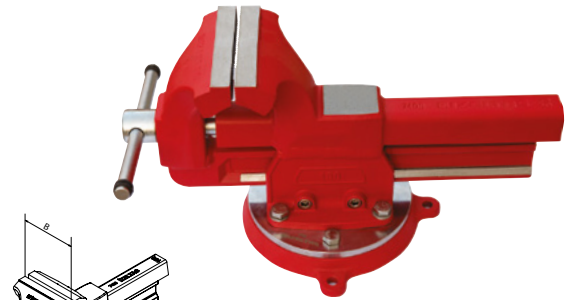

Özel alaşım çelik, Fırın boya  
Special steel, Electrostatic Paint

KOD CODE	B mm	g	TL/Ad.
7400 00 0100	100	6550	781,00
7400 00 0125	125	13700	1065,50
7400 00 0150	150	23800	1347,50
7400 00 0175	175	35650	1629,50

İşkence (Marangoz Mengenesi Plastik Ağızlı)  
Carpenter Screw Clamp

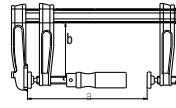

Darbeye dayanıklı çeneler  
Impact resistant cast iron jaws

KOD CODE		a mm	b mm	g		TL/Ad.
7300 30 3012	30x12	300	120	1605	5	108,85
7300 30 4012	40x12	400	120	1780	5	115,10
7300 30 5012	50x12	500	120	1935	5	120,45
7300 30 6012	60x12	600	120	2080	5	127,55
7300 30 8012	80x12	800	120	2470	5	139,95
7300 30 1012	100x12	1000	120	2790	5	150,45

Mini İşkence  
Mini Clamp

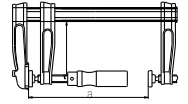

Alaşımlı alüminyum çeneler  
Alloyed aluminum jaws

KOD CODE		a mm	b mm	g		TL/Ad.
7310 30 1005	10x5	100	50	250	5	52,45
7310 30 1505	15x5	150	50	280	5	55,30
7310 30 2005	20x5	200	50	310	5	57,25
7310 30 2505	25x5	250	50	330	5	59,75
7310 30 3005	30x5	300	50	360	5	61,85



# 9

## Makaslar Shears



- |                                  |                             |
|----------------------------------|-----------------------------|
| <i>Demir Kesme Makası</i>        | <i>Bolt Cutters</i>         |
| <i>Saç Makasları</i>             | <i>Sheet Metal Cutters</i>  |
| <i>Plastik Boru Kesme Makası</i> | <i>Plastic Pipe Cutters</i> |
| <i>Bağ Makasları</i>             | <i>Prunig Shears</i>        |

2350

Demir Kesme Makası  
Bolt Cutters



Yedek parça sayfa 164  
Spare parts page 164

Özel alaşımli çelik, Kesici ağızlar indüksiyonda sertleştirilmiş,  
Elektrostatik boyanmış çeneler ve bağlantı parçaları dövme  
Special steel, Cutters induction hardened,  
Electrostatically painted jaws and connection parts drop forged

KOD CODE	L mm	L inch	KAPASİTE CAPACITY Ø mm	g	TL/Ad.
2350 27 0018	450	18"	6 - 8	1510	1 260,55
2350 27 0024	600	24"	8 - 10	2350	1 383,55
2350 27 0030	750	30"	9 - 13	3750	1 600,60
2350 27 0036	900	36"	11 - 16	5500	1 777,25

2350

Demir Kesme Makası Sehpa  
Bolt Cutters Frame



KOD CODE	İÇERİK CONTENTS	g	TL/Ad.
2350 00 6104	18"(450) - 24"(600) 30"(750) - 36"(900)	21.110	4 2306,95

6205

Alüminyum Ve Sac Kesme Makası Sağ  
Snip For Aluminum and Metal Sheet (Right)



Özel alaşımli çelik, Kesici ağızlar indüksiyonda sertleştirilmiş,  
Special steel, Cutters induction hardened,

KOD CODE	L mm	L inch	g	TL/Ad.
6205 27 0240	240	10"	380	5 78,10

6206

Alüminyum Ve Sac Kesme Makası Sol  
Snip For Aluminum and Metal Sheet (Left)



Özel alaşımli çelik, Kesici ağızlar indüksiyonda sertleştirilmiş  
Special steel, Cutters induction hardened

KOD CODE	L mm	L inch	g	TL/Ad.
6206 27 0240	240	10"	380	5 78,10

6207

Alüminyum Ve Sac Kesme Makası Düz  
Snip For Aluminum and Metal Sheet (Flat)



Özel alaşımli çelik, Kesici ağızlar indüksiyonda sertleştirilmiş  
Special steel, Cutters induction hardened

KOD CODE	L mm	L inch	g	TL/Ad.
6207 27 0240	240	10"	380	5 78,10

## 6210

**Kaportacı Makası (Sağ)**  
*Punch Snip (Right)*

DIN 6438



Özel alaşımlı çelik, Kesici ağızlar induksiyonda sertleştirilmiş, PVC izoleli  
*Special steel, Cutters induction hardened, PVC insulated*

KOD CODE	L mm	L inch	g	TL/Ad.
6210 27 0250	250	10"	555	97,70
6210 27 0275	275	11"	600	106,85
6210 27 0300	300	12"	640	128,10

## 6820

**Tenekeci Makası**  
*Tinman's Snip*

TSEK



Özel alaşımlı çelik, Kesici ağızlar induksiyonda sertleştirilmiş, PVC izoleli  
*Special steel, Cutters induction hardened, PVC insulated*

KOD CODE	L mm	L inch	g	TL/Ad.
6820 27 0200	200	8"	320	74,75
6820 27 0250	250	10"	575	86,80
6820 27 0300	300	12"	870	104,15

## 6211

**Kaportacı Makası (Sol)**  
*Punch Snip (Left)*

DIN 6438



Özel alaşımlı çelik, Kesici ağızlar induksiyonda sertleştirilmiş, PVC izoleli  
*Special steel, Cutters induction hardened, PVC insulated*

KOD CODE	L mm	L inch	g	TL/Ad.
6211 27 0250	250	10"	535	97,70
6211 27 0275	275	11"	605	106,85
6211 27 0300	300	12"	665	128,10

## 6821

**Tenekeci Makası (Yaylı)**  
*Tinman's Snip (With Spring)*

TSEK



Özel alaşımlı çelik, Kesici ağızlar induksiyonda sertleştirilmiş, PVC izoleli  
*Special steel, Cutters induction hardened, PVC insulated*

KOD CODE	L mm	L inch	g	TL/Ad.
6821 27 0250	250	10"	575	94,30
6821 27 0300	300	12"	895	113,55

6800

Kuyumcu Makası (Düz)  
Jeweller's Snip (Straight)



KOD CODE	L mm	L inch	g	TL/Ad.
6800 27 0180	180	7 1/8"	140	5 86,50

6815

Tel Kesme Makası  
Bolt Cutters



KOD CODE	L mm	L inch	g	TL/Ad.
6815 27 0200	200	8"	295	5 38,50

6801

Kuyumcu Makası (Eğri)  
Jeweller's Snip (Curved)



KOD CODE	L mm	L inch	g	TL/Ad.
6801 27 0180	180	7 1/8"	140	5 92,10

6740

Kombine Makas  
Multi Purpose Scissors



KOD CODE	L mm	L inch	g	TL/Ad.
6740 27 0140	140	5 1/2"	60	5 80,45
6740 27 0190	190	7 1/2"	120	5 91,20

**6710**

**Bağ Makası (Lüks)**  
*Pruning Shears (Lux)*



Özel alaşımlı çelik, Kesici ağızlar induksiyonda sertleştirilmiş, PVC izoleli  
*Special steel, Cutters induction hardened, PVC insulated*

KOD CODE	L mm	L inch	g	TL/Ad.
6710 27 0230	230	9"	390	5 78,85

**6720**

**Bağ Makası (Hafif Tip)**  
*Pruning Shears (Light)*



Alüminyum gövde, PVC izoleli  
*Aluminum forged body, PVC insulated*

KOD CODE	L mm	L inch	g	TL/Ad.
6720 27 0220	220	8 5/8"	265	5 139,35

**6715**

**Bağ Makası (Comfort)**  
*Pruning Shears (Comfort)*



Özel alaşımlı çelik, PVC izoleli  
*Special steel, PVC insulated*

KOD CODE	L mm	L inch	g	TL/Ad.
6715 27 0225	225	9"	340	5 120,15

**6712**

**Elma Makası**  
*Pruning Shears (Fruit)*



Özel alaşımlı çelik, Kesici ağızlar induksiyonda sertleştirilmiş, PVC izoleli  
*Special steel, Cutters induction hardened, PVC insulated*

KOD CODE	L mm	L inch	g	TL/Ad.
6712 27 0210	210	8 1/4"	365	5 127,45

06760

Plastik Boru Kesme Makası  
Plastic Pipe Cutter



Yedek parça sayfa 165  
Spare parts page 165

KOD CODE	Ø mm	g		TL/Ad.
06760 50 042	42	400	5	284,85
06760 50 063	63	610	5	500,00

6860

Teleskopik Boru Kesici (Bakır ve Alüminyum İçin)  
Telescopic Tube Cutter (For Copper and Aluminum)



Yedek parça sayfa 166  
Spare parts page 166

KOD CODE	ÖLÇÜ SIZE	g		TL/Ad.
6860 28 0635	1/4" - 1 3/8"	470	1	157,70

6850

Mini Boru Kesici (Bakır ve Alüminyum İçin)  
Mini Tube Cutter (For Copper and Aluminum)



Yedek parça sayfa 166  
Spare parts page 166

KOD CODE	ÖLÇÜ SIZE	g		TL/Ad.
6850 28 0322	1/8" - 5/8"	120	1	57,85

6865

Profesyonel Boru Kesici (Çelik İçin)  
Professional Tube Cutter (For Steel)



Yedek parça sayfa 166  
Spare parts page 166

KOD CODE	ÖLÇÜ SIZE	g		TL/Ad.
6865 28 1050	1/8" - 2"	2380	1	398,25

6855

Standart Boru Kesici (Bakır ve Alüminyum İçin)  
Standard Tube Cutter (For Copper and Aluminum)



Yedek parça sayfa 166  
Spare parts page 166

KOD CODE	ÖLÇÜ SIZE	g		TL/Ad.
6855 28 0330	1/8" - 1 1/8"	305	1	74,15





10

# Çektirmeler Pullers



Çektirmeler Pullers  
İç Rulman Çektirmeler Inside Pullers  
Rotil Çektirmeler Balljoint Pullers  
Saplama Sökmeler Stud Inserters and Removers

7010

Standart Çektirme (İki Kollu)  
Standard Puller (Two Arms)

TSEK

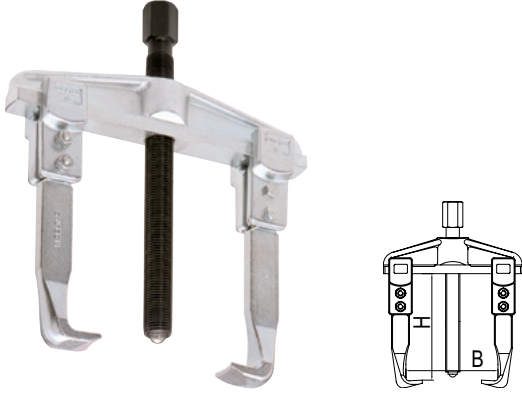

Yedek parça sayfa 166  
Spare parts page 166

Krom vanadyum, Çinko kaplı, Kollar sertleştirilmiş,  
Mil indüksiyonda sertleştirilmiş  
Chrom vanadium, Zinc plated,  
Arms hardened, Spindle induction hardened

KOD CODE		B mm	H mm			
7010 29 0810	8x10	80	100	1080	1	240,15
7010 29 1210	12x10	120	100	1235	1	256,80
7010 29 1615	16x15	160	150	2850	1	437,85
7010 29 2015	20x15	200	150	3060	1	478,90
7010 29 2520	25x20	250	200	4400	1	827,25
7010 29 3520	35x20	350	200	9900	1	1004,70
7010 29 5220	52x20	520	200	13500	1	1476,95

7010

Çektirme Sehpa'sı  
Display Frame For Pullers



KOD CODE	İÇERİK CONTENTS			
7010 00 6105	8x10 - 12x10 - 16x15 20x15 - 25x20	17840	5	2308,25

7020

Standart Çektirme (Üç Kollu)  
Standart Puller (Three Arms)

TSEK



Yedek parça sayfa 166  
Spare parts page 166

Krom vanadyum, Çinko kaplı, Kollar sertleştirilmiş,  
Mil indüksiyonda sertleştirilmiş  
Chrom vanadium, Zinc plated,  
Arms hardened, Spindle induction hardened

KOD CODE		B mm	H mm			
7020 29 3720	37x20	370	200	13700	1	1854,15
7020 29 5220	52x20	520	200	17815	1	2556,10

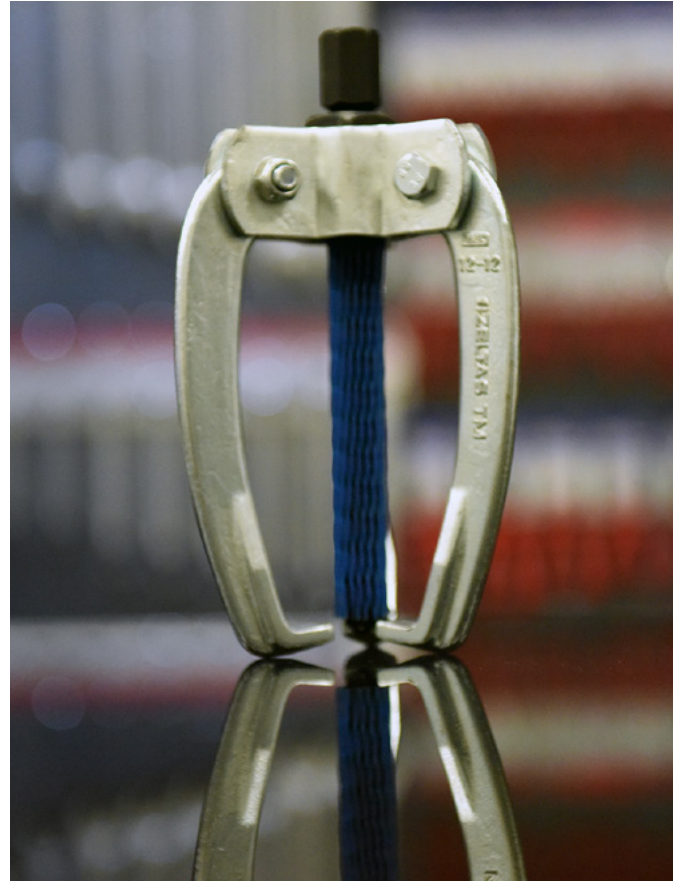

## 7030

### Master Çektirme (İki Kollu) Master Puller (Two Arms)

TSEK

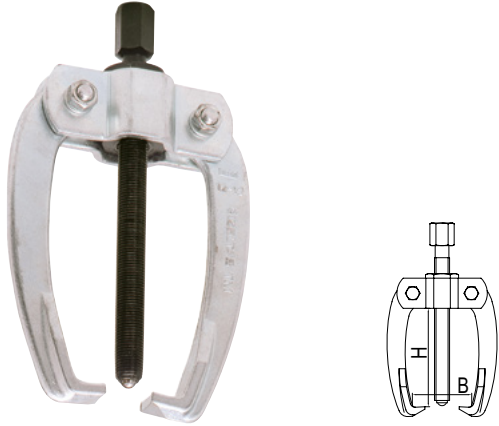

Yedek parça sayfa 166  
Spare parts page 166

Krom vanadyum, Çinko kaplı, Kollar sertleştirilmiş,  
Mil indüksiyonda sertleştirilmiş  
Chrom vanadium, Zinc plated,  
Arms hardened, Spindle induction hardened

KOD CODE		B mm	H mm	g	TL/Ad.
7030 29 0808	8x8	80	80	545	1 96,65
7030 29 1212	12x12	120	120	1075	1 199,40
7030 29 1616	16x16	160	160	1885	1 300,05
7030 29 2320	23x20	230	200	3240	1 408,05

## 7050

### Batarya Çektirme (İki Kollu) Battery Puller (Two Arms)

TSEK

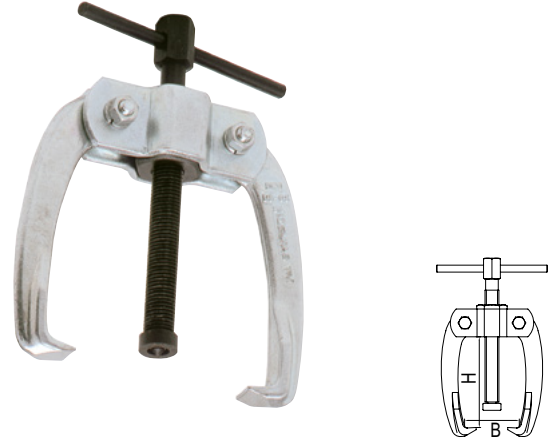

Yedek parça sayfa 166  
Spare parts page 166

Krom vanadyum, Çinko kaplı, Kollar sertleştirilmiş,  
Mil indüksiyonda sertleştirilmiş  
Chrom vanadium, Zinc plated,  
Arms hardened, Spindle induction hardened

KOD CODE		B mm	H mm	g	TL/Ad.
7050 29 0604	6x4	60	40	245	1 107,50
7050 29 0606	6x6	60	60	275	1 110,85
7050 29 0808	8x8	80	80	555	1 116,50

## 7040

### Master Çektirme (Üç Kollu) Master Puller (Three Arms)

TSEK



Yedek parça sayfa 166  
Spare parts page 166

Krom vanadyum, Çinko kaplı, Kollar sertleştirilmiş,  
Mil indüksiyonda sertleştirilmiş  
Chrom vanadium, Zinc plated,  
Arms hardened, Spindle induction hardened

KOD CODE		B mm	H mm	g	TL/Ad.
7040 29 0808	8x8	80	80	680	1 185,25
7040 29 1212	12x12	120	120	1355	1 271,15
7040 29 1616	16x16	160	160	2320	1 398,75
7040 29 2320	23x20	230	200	4025	1 536,95

## 7060

### Batarya Çektirme (Üç Kollu) Battery Puller (Three Arms)

TSEK

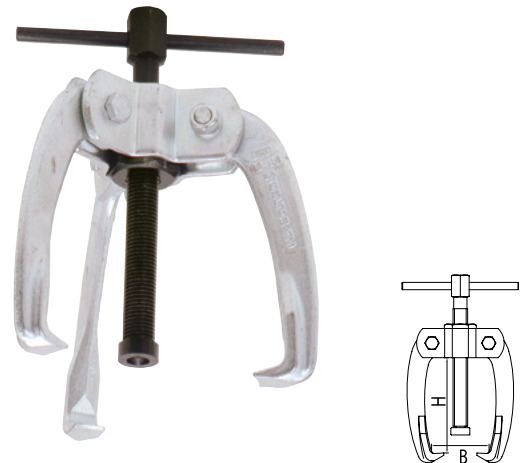

Yedek parça sayfa 166  
Spare parts page 166

Krom vanadyum, Çinko kaplı, Kollar sertleştirilmiş,  
Mil indüksiyonda sertleştirilmiş  
Chrom vanadium, Zinc plated,  
Arms hardened, Spindle induction hardened

KOD CODE		B mm	H mm	g	TL/Ad.
7060 29 0604	6x4	60	40	300	1 139,60
7060 29 0606	6x6	60	60	345	1 176,10
7060 29 0808	8x8	80	80	715	1 204,25

7070

S Tipi Çektirme (İki Kollu)  
S Type Puller (Two Arms)

TSEK

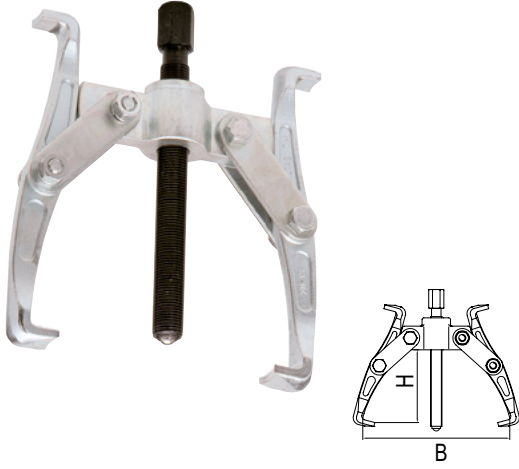

Yedek parça sayfa 166  
Spare parts page 166

Krom vanadyum, Çinko kaplı, Kollar sertleştirilmiş,  
Mil indüksiyonda sertleştirilmiş  
Chrom vanadium, Zinc plated,  
Arms hardened, Spindle induction hardened

KOD CODE		B mm	H mm	g		TL/Ad.
7070 29 2013	20x13	200	130	2420	1	265,00

7090

Üniversal Çektirme (İki Kollu)  
Universal Puller (Two Arms)

TSEK

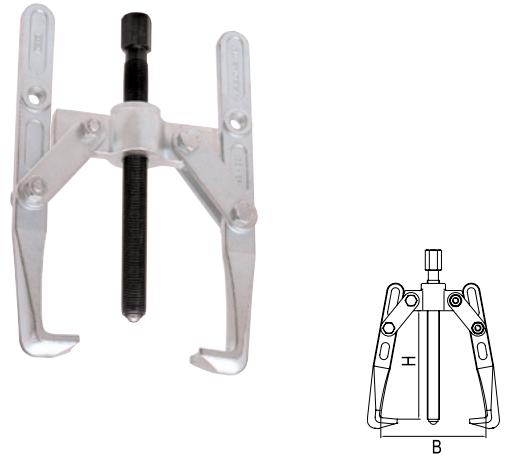

Yedek parça sayfa 166  
Spare parts page 166

Krom vanadyum, Çinko kaplı, Kollar sertleştirilmiş,  
Mil indüksiyonda sertleştirilmiş  
Chrom vanadium, Zinc plated,  
Arms hardened, Spindle induction hardened

KOD CODE		B mm	H mm	g		TL/Ad.
7090 29 2222	22x22	220	220	3085	1	294,55

7080

S Tipi Çektirme (Üç Kollu)  
S Type Puller (Three Arms)

TSEK

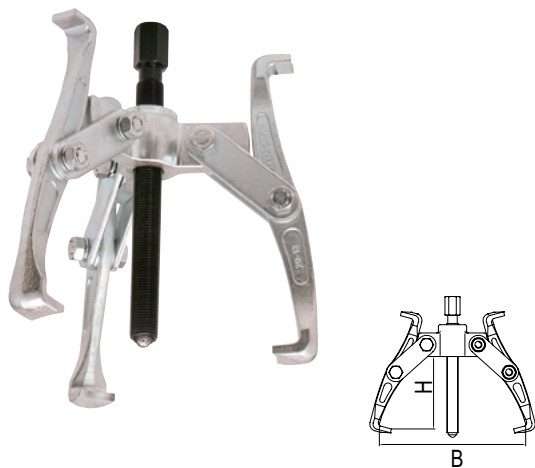

Yedek parça sayfa 166  
Spare parts page 166

Krom vanadyum, Çinko kaplı, Kollar sertleştirilmiş,  
Mil indüksiyonda sertleştirilmiş  
Chrom vanadium, Zinc plated,  
Arms hardened, Spindle induction hardened

KOD CODE		B mm	H mm	g		TL/Ad.
7080 29 2013	20x13	200	130	3250	1	341,80

7100

Üniversal Çektirme (Üç Kollu)  
Universal Puller (Three Arms)

TSEK

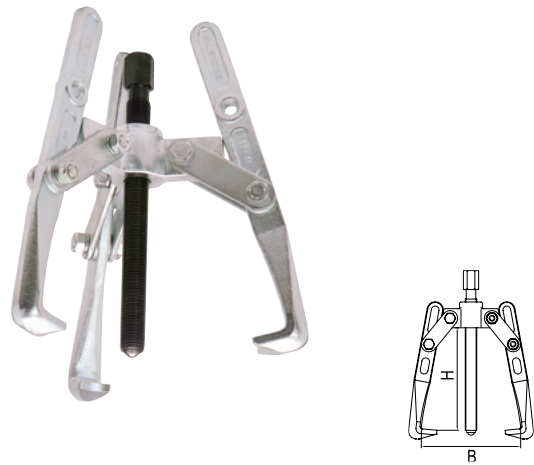

Yedek parça sayfa 166  
Spare parts page 166

Krom vanadyum, Çinko kaplı, Kollar sertleştirilmiş,  
Mil indüksiyonda sertleştirilmiş  
Chrom vanadium, Zinc plated,  
Arms hardened, Spindle induction hardened

KOD CODE		B mm	H mm	g		TL/Ad.
7100 29 2222	22x22	220	220	4125	1	386,10

10

**7120**

### İç Rulman Çektirme Pensleri - Model A

Internal Expansion Puller - Model A

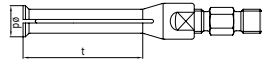

KOD CODE	øD mm	Kullanılan Kol / For	t mm	Adaptör vidası	g	TL/Ad.
7120 29 0507	5 - 7	35 - 75	30	M10	40	1 191,55
7120 29 0709	7 - 9	35 - 75	30	M10	40	1 191,55
7120 29 0912	9 - 12	35 - 75	30	M10	40	1 177,50
7120 29 1013	10 - 13	35 - 75	30	M10	40	1 177,50
7120 29 1317	13 - 17	35 - 75	50	M10	60	1 177,50
7120 29 1419	14 - 19	35 - 75	60	M10	75	1 181,80
7120 29 1621	16 - 21	35 - 75	60	M10	75	1 181,80
7120 29 1823	18 - 23	35 - 75	60	M10	100	1 217,70
7120 29 2025	20 - 25	35 - 75	60	M10	100	1 229,85
7120 29 2530	25 - 30	35 - 75	60	M10	110	1 239,40
7120 29 3037	30 - 37	35 - 75 60 - 130	70	M10	250	1 277,40
7120 29 3542	35 - 42	35 - 75 60 - 130	70	M10	250	1 291,50
7120 29 3845	38 - 45	35 - 75 60 - 130	70	M10	250	1 307,30
7120 29 4350	43 - 50	35 - 75 60 - 130	70	M10	400	1 349,45

**7120**

### İç Rulman Çektirme Pensleri - Model B

Internal Expansion Puller - Model B

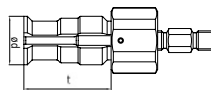

KOD CODE	øD mm	Kullanılan Kol / For	t mm	Adaptör vidası	g	TL/Ad.
7120 29 2540	25 - 40	35 - 75 60 - 130	45	M10	235	1 388,00

**7120**

### İç Rulman Çektirme Kolları

Arms For Internal Expansion Puller



Krom vanadyum, Çinko kaplı, Kollar sertleştirilmiş,  
Mil indüksiyonda sertleştirilmiş  
Chrom vanadium, Zinc plated,  
Arms hardened, Spindle induction hardened

KOD CODE	Kapasite Capacity mm	Kullanılan pensler / For	Adaptör vidası Screw Adapter	g	TL/Ad.
7120 29 3575	35 - 75	Model A 5 - 7'den 43 - 50'ye Model B 25 - 40	M10	625	1 195,15
7120 29 6013	60 - 130	Model A 30 - 37'den 43 - 50'ye Model B 25 - 40	M10	1000	1 395,55

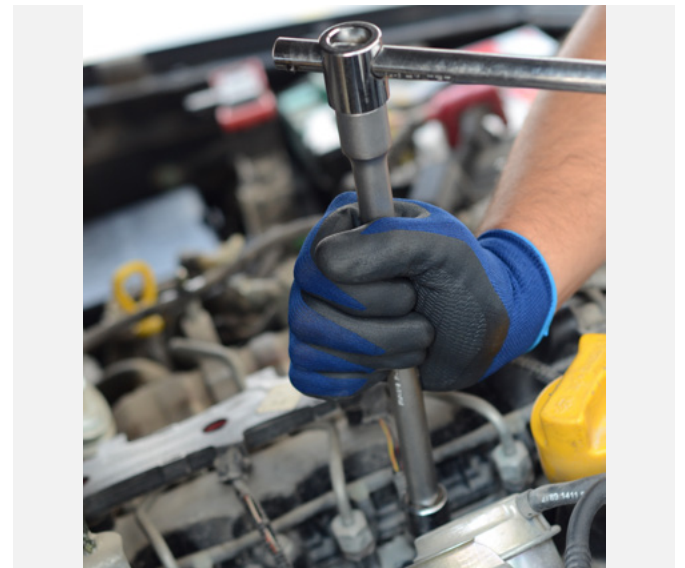

Dış Rulman Çektirme Çeneleri  
Seperator



Krom vanadyum, Çinko kaplı, Kollar sertleştirilmiş,  
Mil indüksiyonda sertleştirilmiş  
Chrom vanadium, Zinc plated,  
Arms hardened, Spindle induction hardened

KOD CODE	Ø mm	Kullanılan Kollar / For	Adaptör vidası	g	TL/Ad.
7122 29 0560	5 - 60	40 - 115	M12	370	1 296,25
7122 29 1275	12 - 75	40 - 115	M12	635	1 355,05
7122 29 2211	22 - 115	55 - 205	M16x1.5	1780	1 554,50
7122 29 2515	25 - 155	90 - 260	M20x1.5	3940	1 868,05
7122 29 3022	30 - 220	100 - 360	M20x1.5	11000	1 2372,50
7122 29 4028	40 - 280	140 - 435	M24x1.5	15000	1 5299,15

Dış Rulman Çektirme Kolları  
Puller Arms For Separator

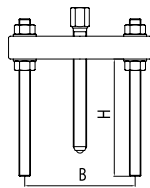

Krom vanadyum, Çinko kaplı, Kollar sertleştirilmiş,  
Mil indüksiyonda sertleştirilmiş  
Chrom vanadium, Zinc plated,  
Arms hardened, Spindle induction hardened

KOD CODE	B mm	Kullanılan Çene / For	H mm	Adaptör vidası	g	TL/Ad.
7122 29 4011	40-115	5 - 60 12 - 75	150	M12	990	1 528,30
7122 29 5520	55-205	22 - 115	210	M16x1.5	2700	1 836,30
7122 29 9026	90-260	25 - 155	315	M20x1.5	4965	1 1184,05
7122 29 1036	100-360	30 - 220	305	M20x1.5	7000	1 2436,90
7122 29 1443	140-435	40 - 280	320	M24x1.5	11000	1 4763,05

Rotil Çektirme  
Extractor For Ball Joint

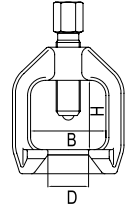

KOD CODE	ØD mm	B mm	H mm	g	TL/Ad.
7126 29 0018	18	40	40	315	1 163,80
7126 29 0025	25	50	50	540	1 224,60
7126 29 0029	29	60	60	915	1 298,85
7126 29 0040	40	80	80	1965	1 421,95
7126 29 0045	45	90	100	2670	1 532,70

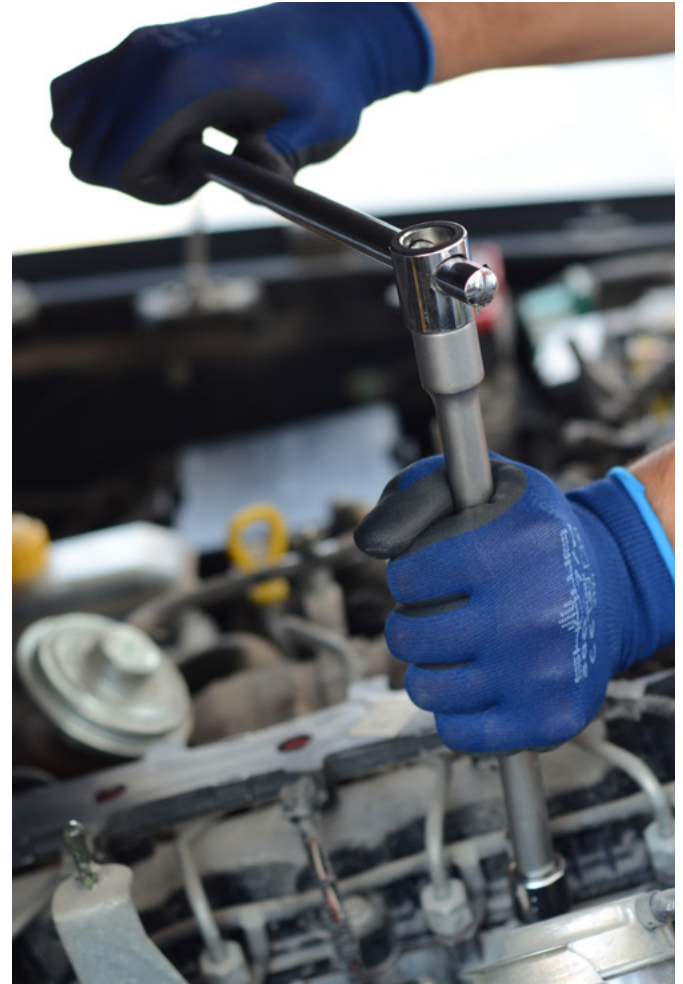

11

*Elta*



**Anahtarlar**  
*Wrenches*

**Tornavida ve Allen Anahtarlar**  
*Screwdrivers and Hex Key Wrenches*

**Lokma ve Bijon Anahtarları**  
*Sockets and Rim Wrenches*

**Keskiler ve Çekiçler**  
*Chisels and Hammers*

**Boru Anahtarları ve Penseler**  
*Pipe Wrenches and Pliers*

**Servis Alet ve Ekipmanları**  
*Maintenance Tools and Equipment*

İki Ağız Anahtar (mm)  
Double Ended Open Jaw Wrench (mm)



TS 81 • DIN 895

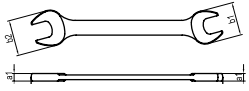

Krom vanadyum, Krom kaplı  
Chrom vanadium, Chrom plated

KOD CODE	mm	L mm	a1 mm	b1 mm	b2 mm	g	TL/Ad.
0150 01 0607	6x7	98	3.3	13.5	15.5	10	6,70
0150 01 0809	8x9	108	3.6	17.5	19.5	20	6,85
0150 01 1011	10x11	120	4	21.5	23.5	30	7,45
0150 01 1213	12x13	134	4.5	25.6	27.6	40	8,20
0150 01 1415	14x15	150	5	29.6	31.5	60	9,55
0150 01 1617	16x17	163	5.5	33.5	35.5	85	11,10
0150 01 1819	18x19	178	6	37.4	39.4	110	11,90
0150 01 2022	20x22	198	6.5	41.4	45.5	145	13,50
0150 01 2123	21x23	218	6.9	43.5	47.5	175	14,70
0150 01 2426	24x26	236	7.4	49.4	53.5	235	15,80
0150 01 2528	25x28	250	7.8	51.5	57.5	275	19,60
0150 01 2732	27x32	265	8.3	55.5	65.6	345	23,45

0150

İki Ağız Anahtar Takımı (mm)  
Double Ended Open Jaw Wrench Set (mm)

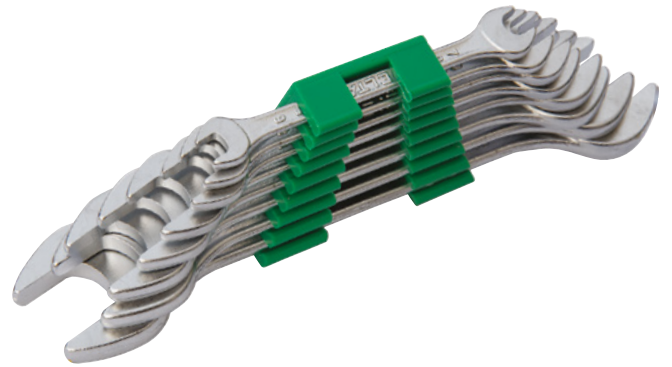

KOD CODE	İÇERİK CONTENTS	g	TL/Ad.
0150 00 2108	6x7 - 8x9 - 10x11 12x13 - 14x15 - 16x17 18x19 - 20x22	560	8 75,25
0150 00 2112	6x7 - 8x9 - 10x11 12x13 - 14x15 - 16x17 18x19 - 20x22 - 21x23 24x26 - 25x28 - 27x32	1590	12 148,80





0350

Kombine Anahtar (mm)  
Combination Wrench (mm)



TS 3794  
DIN 6453  
TS ISO 7738 Form A

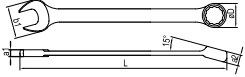

Krom vanadyum, Krom kaplı  
Chrom vanadium, Chrom plated

KOD CODE	mm	L mm	a1 mm	a2 mm	b1 mm	øD mm	g	TL/Ad.	
0350 02 0006	6	95	3.1	5.1	13.5	15.1	15	10	8,80
0350 02 0007	7	104	3.3	5.5	15.5	11.5	15	10	9,35
0350 02 0008	8	112	3.7	5.9	17.5	12.8	20	10	10,15
0350 02 0009	9	121	3.9	6.3	19.5	14.1	25	10	10,45
0350 02 0010	10	130	4.3	6.9	21.5	15.3	30	10	11,80
0350 02 0011	11	138	4.5	7.3	23.4	16.3	35	10	12,15
0350 02 0012	12	146	4.9	7.7	25.6	17.8	45	10	12,95
0350 02 0013	13	154	5.1	8.1	27.6	19	50	10	13,25
0350 02 0014	14	163	5.5	8.7	29.6	20.4	60	10	14,25
0350 02 0015	15	171	5.7	9.1	31.5	21.9	70	10	15,30
0350 02 0016	16	180	6.1	9.5	33.5	23.2	85	10	16,40
0350 02 0017	17	189	6.3	9.9	35.5	24.8	95	10	17,55
0350 02 0018	18	200	6.7	10.4	37.4	26.5	110	10	19,55
0350 02 0019	19	211	6.9	11	39.4	27.9	130	10	20,55
0350 02 0020	20	222	7.3	11.4	41.4	29.3	145	10	20,90
0350 02 0021	21	235	7.3	11.4	43.5	31	160	10	24,35
0350 02 0022	22	250	8.1	12.6	45.5	32.5	200	10	27,85
0350 02 0024	24	270	8.7	13.6	49.4	35.7	250	5	34,05
0350 02 0027	27	300	9.6	14.8	55.5	40.1	350	5	40,10
0350 02 0030	30	330	10.2	15.8	61.7	44.7	445	5	46,05
0350 02 0032	32	350	10.4	16.2	65.6	46.8	500	5	48,30

0350

Kombine Anahtar Takımı (mm)  
Combination Wrench Set (mm)

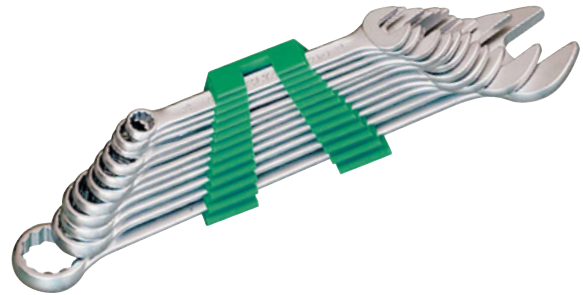

KOD CODE	İÇERİK CONTENTS	g	TL/Ad.	
0350 00 2108	6 - 7 - 8 - 9 - 10 - 13 17 - 19	395	8	101,90
0350 00 2112	8 - 9 - 10 - 11 - 12 13 - 14 - 15 - 16 17 - 19 - 22	855	12	182,65
0350 00 2117	6 - 7 - 8 - 9 - 10 11 - 12 - 13 - 14 15 - 16 - 17 - 18 19 - 20 - 21 - 22	1300	17	265,60
0350 00 2121	6 - 7 - 8 - 9 - 10 11 - 12 - 13 - 14 15 - 16 - 17 - 18 19 - 20 - 21 - 22 24 - 27 - 30 - 32	2810	21	434,10

Yıldız İki Ağız Anahtar (mm)  
Double Ended Ring Wrench (mm)



TS 3794  
DIN 838

TS ISO 10104 Form B



Krom vanadyum, Krom kaplı  
Chrom vanadium, Chrom plated

KOD CODE	mm	L mm	a1 mm	a2 mm	b1 mm	b2 mm	g	TL/Ad.
0450 03 0607	6x7	176	5.5	6	10.5	11.7	45	10 15,25
0450 03 0809	8x9	190	6.5	7	13.8	15.1	60	10 15,45
0450 03 1011	10x11	206	7.5	8	16.1	17.3	90	10 17,15
0450 03 1213	12x13	220	8.5	9	19	20.5	100	10 19,40
0450 03 1415	14x15	236	9.5	10	22.2	23.8	140	10 20,40
0450 03 1617	16x17	250	10.7	11.2	25.2	26.7	190	10 23,10
0450 03 1819	18x19	271	11.7	12	28	29.5	240	10 27,60
0450 03 2022	20x22	291	12.5	13.2	31	34	255	5 30,20
0450 03 2123	21x23	310	12.8	13.4	32.7	35.6	300	5 34,65
0450 03 2426	24x26	331	13.6	14.3	37	40	335	5 40,35
0450 03 2528	25x28	350	13.8	15	38.6	43.1	430	5 44,20
0450 03 2732	27x32	371	14.8	16.4	41.5	48.5	525	5 48,70

0450

Yıldız İki Ağız Anahtar Takımı (mm)  
Double Ended Ring Wrench Set (mm)

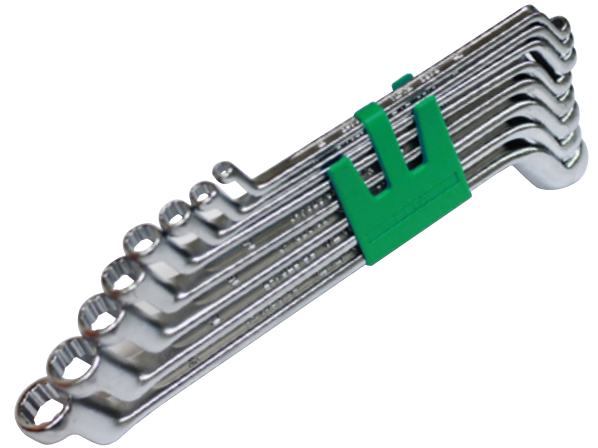

KOD CODE	İÇERİK CONTENTS	g	TL/Ad.
0450 00 2108	6x7 - 8x9 - 10x11 12x13 - 14x15 - 16x17 18x19 - 20x22	1120	8 168,55
0450 00 2112	6x7 - 8x9 - 10x11 12x13 - 14x15 - 16x17 18x19 - 20x22 - 21x23 24x26 - 25x28 - 27x32	2710	12 336,45



## 0601

**Kurbağacak Anahtar**  
*Adjustable Wrench*

TS 3796  
DIN 3117



**Krom vanadyum, Krom kaplı, PVC izoleli**  
*Chrom vanadium, Chrom plated, PVC Insulated*

KOD CODE	L mm	L inch	a mm	g	TL/Ad.
0601 01 0008	206	8"	23	240	5 59,35
0601 01 0010	256	10"	28	400	5 89,35
0601 01 0012	306	12"	34	650	5 114,05

## 1514

**1/2" T Kol**  
*Sliding T - Handle*

TS ISO 3315  
DIN 3122



**Krom vanadyum, Krom kaplı**  
*Chrom vanadium, Chrom plated*

## 1/2"

KOD CODE	L mm	g	TL/Ad.
1514 06 4025	250	370	5 43,90

## 1115

**1/2" Altı Köşe Lokma Anahtar (mm)**  
*Socket Wrench 6 Points (mm)*

TS ISO 2725  
DIN 3124

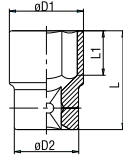

**Krom vanadyum, Krom kaplı**  
*Chrom vanadium, Chrom plated*

## 1/2"

KOD CODE	mm	D1 mm	D2 mm	L mm	L1 mm	g	TL/Ad.
1115 06 0010	10	15	23.3	38	8	60	10 11,05
1115 06 0011	11	16.4	23.3	38	8	60	10 11,05
1115 06 0012	12	17.8	23.3	38	9	60	10 11,05
1115 06 0013	13	19	23.3	38	10	60	10 11,50
1115 06 0014	14	20.4	23.3	38	11	60	10 11,50
1115 06 0015	15	21.6	23.3	38	11	65	10 11,50
1115 06 0016	16	22.9	24	38	11	70	10 12,00
1115 06 0017	17	24	22.5	38	12	70	10 12,00
1115 06 0018	18	25.2	23	38	13	75	10 12,00
1115 06 0019	19	26.8	23	38	13	75	10 12,90
1115 06 0020	20	28	23	38	13	80	10 12,90
1115 06 0021	21	29.2	23	38	13	80	5 12,90
1115 06 0022	22	30.2	24	40	15	95	5 12,90
1115 06 0023	23	31.4	25	40	15	100	5 14,00
1115 06 0024	24	32.6	26	42	17	115	5 14,00
1115 06 0026	26	35.3	28	42	17	130	5 15,75
1115 06 0027	27	36.6	28	42	19	140	5 17,90
1115 06 0028	28	37.8	30	42	20	160	5 18,90
1115 06 0030	30	40	29.5	44	21	175	5 18,90
1115 06 0032	32	42.5	30	44	23	180	5 20,20

## 1514

**1/2" T Kol Adaptörü**  
*Adapter*



**Krom vanadyum, Krom kaplı**  
*Chrom vanadium, Chrom plated*

## 1/2"

KOD CODE	L mm	g	TL/Ad.
1514 06 6250	40	90	5 23,00

## 1514

**1/2" Ara Kol**  
*Extension Bar*

TS ISO 1174  
DIN 3123



**Krom vanadyum, Krom kaplı**  
*Chrom vanadium, Chrom plated*

## 1/2"

KOD CODE	L mm	g	TL/Ad.
1514 06 4125	125	220	5 25,25
1514 06 4250	250	425	5 43,90

1514

1/2" Mafsal  
Universal Joint

TS ISO 1174  
DIN 3123



1/2"

Krom vanadyum, Krom kaplı  
Chrom vanadium, Chrom plated

KOD CODE	L mm	g	TL/Ad.
1514 06 4065	65	140	5 30,15

1514

1/2" Cırcır Kolu  
Ratchet Handle

TS ISO 3315  
DIN 3122



1/2"

Krom vanadyum, Krom kaplı  
Chrom vanadium, Chrom plated

KOD CODE	L mm	g	TL/Ad.
1514 06 5250	250	585	5 103,05

1115

1/2" Altı Köşe Lokma Anahtar Takımı (17 Parça, mm)  
Socket Wrench Set 6 Points (17 pcs, mm)



1/2"

KOD CODE	LOKMALAR Sockets	AVADANLIKLAR Accessories	g	TL/Ad.
1115 00 2017	10 - 11 - 12 13 - 14 - 15 17 - 19 - 22 24 - 27 - 30 32	1/2" Cırcır Kolu Ratchet Handle 1/2" T Kol Adaptör Sliding T Handle Adapter 1/2" Mafsal Universal Joint 1/2" Ara Kol Extension Bar 250 mm	2650	17 376,55

1115

1/2" Altı Köşe Lokma Anahtar Takımı (24 Parça, mm)  
Socket Wrench Set 6 Points (24 pcs, mm)



1/2"

KOD CODE	LOKMALAR Sockets	AVADANLIKLAR Accessories	g	TL/Ad.
1115 00 2024	10 - 11 - 12 13 - 14 - 15 16 - 17 - 18 19 - 21 - 22 23 - 24 - 26 27 - 28 - 30 - 32	1/2" Cırcır Kolu Ratchet Handle 1/2" Mafsal Universal Joint 1/2" T Kol Adaptör Sliding T Handle Adapter 1/2" Ara Kol Extension Bar 125 mm 1/2" Ara Kol Extension Bar 250 mm	3485	24 487,35

## 2203

### Maşalı Boru Anahtarı (85°) Pipe Wrench (85°)

DIN 5234

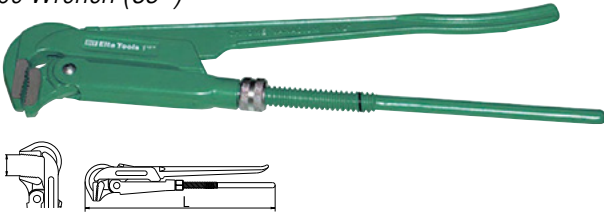

Krom vanadyum, Dişler induksiyonda sertleştirilmiş, Elektrostatik boyanmış  
Chrom vanadium, Teeth induction hardened, Electrostatically painted

KOD CODE	L mm	mm	inch	g		TL/Ad.
2203 10 0010	310	45	1"	760	1	87,30
2203 10 0015	425	60	1 1/2"	1360	1	134,20
2203 10 0020	560	75	2"	2350	1	200,10
2203 10 0030	760	105	3"	3200	1	306,75

## 2401

### Fort Pense Waterpump Pliers

TS 60  
DIN 8976



Krom vanadyum, Nikel kaplı, PVC izoleli  
Chrom vanadium, Nickel plated, PVC Insulated

KOD CODE	L mm	L inch	mm	g		TL/Ad.
2401 11 0240	240	9 1/2"	35	375	5	72,30

## 2509

### Ayarlı Pense Grip



Çeneler krom vanadyum çeliğinden dövülmüştür, Nikel kaplama,  
Kullanım sahası: Yuvarlak ve düz malzemeler  
Jaws Chrom vanadium forged, Nickel plated  
Appatation field : Flat and round materials

KOD CODE	L mm	L inch	mm	g		TL/Ad.
2509 11 0225	225	9"	30	470	5	68,65

## 3021

### Kombine Pense Opak Combination Pliers

TS 60  
DIN ISO 5746



Özel alaşımli çelik, Kesici ağızlar induksiyonda sertleştirilmiş, Krom kaplı, PVC saplı  
Special steel, Cutters induction hardened, Chrom plated, PVC handle

KOD CODE	L mm	L inch	MODEL	g		TL/Ad.
3021 12 1160	160	6 1/4"	OPAK	200	5	40,35
3021 12 1180	180	7 1/8"	OPAK	250	5	49,40
3021 12 1200	200	8"	OPAK	310	5	60,25

## 3221

### Kargaburun Düz Uçlu Opak Long Nose Pliers (Flat)

TS 60  
TS ISO 5745

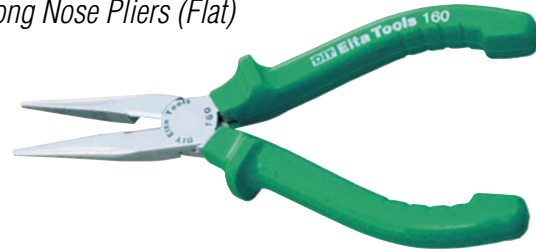

Özel alaşımli çelik, Kesici ağızlar induksiyonda sertleştirilmiş, Krom kaplı, PVC saplı  
Special steel, Cutters induction hardened, Chrom plated, PVC handle

KOD CODE	L mm	L inch	MODEL	g		TL/Ad.
3221 13 1160	160	6 1/4"	OPAK	145	5	43,75
3221 13 1200	200	8"	OPAK	190	5	50,15

## 3701

### Yan Keski Opak Side Cutting Pliers

TS 60  
TS ISO 5749  
DIN 5749



Özel alaşımli çelik, Kesici ağızlar induksiyonda sertleştirilmiş, Krom kaplı, PVC saplı  
Special steel, Cutters induction hardened, Chrom plated, PVC handle

KOD CODE	L mm	L inch	MODEL	g		TL/Ad.
3701 16 1140	140	5 1/2"	OPAK	160	5	37,10
3701 16 1160	160	6 1/4"	OPAK	220	5	43,70

3801

Kerpeten  
Carpenter Pincers

TS 60  
TS ISO 9243  
DIN ISO 9243



Özel alaşımlı çelik, Kesici ağızlar indüksiyonda sertleştirilmiş,  
Vernikli, PVC izoleli  
Special steel, Cutters induction hardened, Lacquered, PVC Insulated

KOD CODE	L mm	L inch	g		TL/Ad.
3801 15 0160	160	6 1/4"	235	5	40,95
3801 15 0180	180	7 1/8"	245	5	44,20
3801 15 0200	200	8"	390	5	53,55

3832

Betoncu Kerpeteni  
Tower Pincers

TS 60  
TS ISO 9242  
DIN ISO 9242



Özel alaşımlı çelik, Kesici ağızlar indüksiyonda sertleştirilmiş,  
Vernikli, PVC izoleli  
Special steel, Cutters induction hardened, Lacquered, PVC insulated

KOD CODE	L mm	L inch	g		TL/Ad.
3832 15 0225	225	9"	335	5	49,40
3832 15 0250	250	10"	415	5	56,25
3832 15 0280	280	11"	475	5	68,30

4150

Opak Seri Düz Uçlu Tornavida  
Screwdriver, Opak, Flat

TS ISO 2380 - 1  
DIN ISO 2380-1

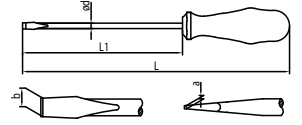

Krom vanadyum, Krom kaplı, PP saplı  
Chrom vanadium, Chrom plated, PP handle

KOD CODE	σDxL1 mm	⊖		L mm	g		TL/Ad.
		a mm	b mm				
4150 17 0380	3x80	0.5	3	150	20	10	7,10
4150 17 0480	4x80	0.8	4	170	30	10	7,35
4150 17 4100	4x100	0.8	4	190	40	10	8,85
4150 17 5100	5x100	1.0	5.5	200	55	10	10,70
4150 17 5125	5x125	1.0	5.5	225	60	10	12,35
4150 17 6100	6x100	1.2	6.5	200	70	10	11,05
4150 17 6125	6x125	1.2	6.5	225	75	10	12,60
4150 17 6150	6x150	1.2	6.5	250	80	10	13,90
4150 17 7150	7x150	1.2	8	260	110	10	16,30
4150 17 8150	8x150	1.6	10	260	130	10	17,70
4150 17 8175	8x175	1.6	10	285	135	10	19,80

4170

Opak Seri Yıldız Uçlu Tornavida  
Screwdriver, Opak Phillips

TS 59 - 5 ISO 8764  
DIN ISO 8764

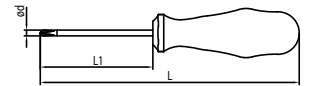

Krom vanadyum, Krom kaplı, PP saplı  
Chrom vanadium, Chrom plated, PP handle

KOD CODE	σDxL1 mm	⊕	L mm	g		TL/Ad.
4170 18 4580	4.5x80	Ph1	170	45	10	11,00
4170 18 6100	6x100	Ph2	200	70	10	13,25
4170 18 8150	8x150	Ph3	260	130	10	25,05

4150

Opak Seri Tornavida Seti (6 parça)  
Screwdriver Set, Opak (6 Pcs)



KOD CODE	İÇERİK CONTENTS	g	TL/Ad.
4150 00 8106	4x80 - 5x100 - 6x125 7x150 Düz uçlu / Flat	545	6
	4.5x80 - 6x100 Yıldız uçlu / Phillips		

4170

Değişken Uçlu Tornavida  
Screwdriver - Reversible

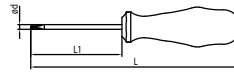

Krom vanadyum, Krom kaplı, PP saplı  
Chrom vanadium, Chrom plated, PP handle

KOD CODE	σDxL1 mm	axb mm	+	L mm	g	TL/Ad.
4170 17 0680	6x80	6x1.2	Ph2	170	60	10, 16,65

4150

Opak Seri Tornavida Seti (7 parça)  
Screwdriver Set, Opak (7 Pcs)



KOD CODE	İÇERİK CONTENTS	g	TL/Ad.
4150 00 8107	3x80 - 4x100 - 5x125 6x150 - 8x175 Düz uçlu / Flat	605	7
	4.5x80 - 6x100 Yıldız uçlu / Phillips		



11

4908

Allen Anahtar Altı Köşe (mm)  
Hex Key Wrench (mm)

TS ISO 2936  
DIN ISO 2936

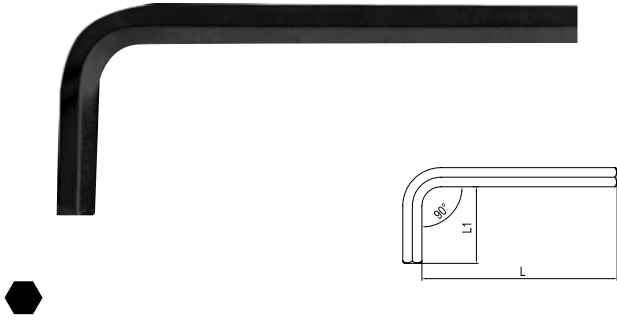

Krom vanadyum, Siyah Oksit Kaplı  
Chrom vanadium, Black finish

KOD CODE	mm	L mm	L1 mm	g	TL/Ad.	
4908 22 0015	1.5	45	14	1.5	10	1,25
4908 22 0020	2	50	16	2	10	1,55
4908 22 0025	2.5	55	18	4	10	1,85
4908 22 0030	3	60	20	6	10	2,10
4908 22 0035	3.5	66	22	8	10	2,30
4908 22 0040	4	73	24	10	10	2,65
4908 22 0050	5	80	28	20	10	2,80
4908 22 0060	6	86	30	30	10	3,65
4908 22 0070	7	92	32	40	10	5,15
4908 22 0080	8	98	34	55	10	6,00
4908 22 0090	9	104	36	75	10	7,85
4908 22 0100	10	112	40	100	10	9,15
4908 22 0120	12	120	45	160	10	12,25

4908

Allen Anahtar Takım Altı Köşe (mm)  
Hex Key Wrench Set (mm)



KOD CODE	İÇERİK CONTENTS	g	TL/Ad.	
4908 00 3107	1.5 - 2 - 2.5 - 3 - 4 - 5 - 6	80	7	15,85
4908 00 3109	1.5 - 2 - 2.5 - 3 - 4 5 - 6 - 8 - 10	235	9	31,00
4908 00 3110	1.5 - 2 - 2.5 - 3 - 4 - 5 6 - 8 - 10 - 12	395	10	43,25

4922

T Tipi Allen Anahtar (mm)  
Hex Key Wrench T - Handle (mm)



Krom vanadyum, Siyah Oksit Kaplı, PP saplı  
Chrom vanadium, Black finish, PP handle

KOD CODE	mm	L mm	L1 mm	g	TL/Ad.	
4922 22 0025	2.5	110	14	15	5	13,85
4922 22 0030	3	125	18	20	5	13,95
4922 22 0040	4	140	22	30	5	14,10
4922 22 0050	5	155	26	55	5	16,05
4922 22 0060	6	170	30	75	5	17,60
4922 22 0070	7	185	34	115	5	18,20
4922 22 0080	8	200	38	150	5	21,95
4922 22 0100	10	220	48	270	5	38,35

4922

T Tipi Allen Anahtar Takımı (8 Parça, mm)  
Hex Key Wrench T - Handle Set (8 Pcs, mm)



KOD CODE	İÇERİK CONTENTS	g	TL/Ad.	
4922 00 8108	2.5 - 3 - 4 - 5 6 - 7 - 8 - 10	730	8	154,05



4915

Kaset Allen Anahtar Takımı (6 Parça, mm)  
Hex Key Wrench Folding Set (6 Pcs, mm)



Krom vanadyum, Siyah oksid kaplı  
Chrom vanadium, Black finish

KOD CODE	İÇERİK CONTENTS	g	TL/Ad.
4915 00 6106	2.5 - 3 - 4 - 5 - 6 - 8	175	1 60,05

5011

Iskarpela (Düz)  
Wood Chisel

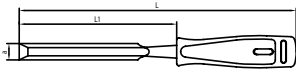

Özel alaşımlı çelik, Uç indüksiyonda sertleştirilmiş, PP Saplı  
Special steel, induction hardened tips, PP Handle

KOD CODE	a mm	L mm	L1 mm	g	TL/Ad.
5011 23 0006	6	275	155	105	5 24,65
5011 23 0008	8	275	155	125	5 26,10
5011 23 0010	10	275	155	140	5 27,60
5011 23 0012	12	275	155	140	5 30,30
5011 23 0014	14	275	155	145	5 31,35
5011 23 0016	16	275	155	165	5 33,50
5011 23 0018	18	275	155	165	5 36,35
5011 23 0020	20	275	155	165	5 40,40
5011 23 0022	22	275	155	180	5 43,80
5011 23 0024	24	275	155	205	5 47,30
5011 23 0026	26	275	155	205	5 49,10
5011 23 0028	28	275	155	205	5 50,70
5011 23 0030	30	275	155	205	5 52,35

5884

Plastik Şerit Metre  
Plastic Measuring tapes



KOD CODE	ÖLÇÜ SIZE	g	TL/Ad.
5884 26 0003	3	95	5 11,15
5884 26 0005	5	195	5 16,10

5891

Testere Kolu  
Hacksaw Frame

DIN 6473



KOD CODE	L mm	g	TL/Ad.
5891 26 0830	300	345	5 44,00

6351

Levye Oluklu  
Tyre Lever, Straight

TSEK



Krom vanadyum, Krom kaplı  
Chrom vanadium, Chrom plated

KOD CODE	L mm	L inch	g	TL/Ad.
6351 26 0400	400	16"	435	5 30,05
6351 26 0500	500	20"	680	5 42,70
6351 26 0600	600	24"	970	5 50,35

6721

Bağ Makası (Lüks)  
Pruning Shears (Lux)

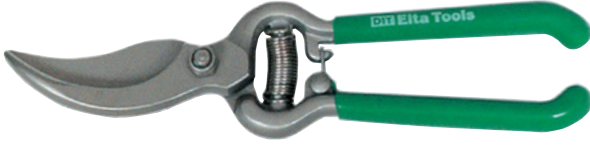

Özel alaşımlı çelik, Kesici ağızlar indüksiyonda sertleştirilmiş, Daldırma PVC izoleli  
Special steel, Cutters induction hardened, PVC dipped

KOD CODE	L mm	L inch	g	TL/Ad.
6721 27 0205	205	8"	290	53,70

6731

Çim Kesme Makası (Eğri Ağız)  
Grass Shears (Wave Edges)



KOD CODE	L mm	L inch	g	TL/Ad.
6731 27 0650	650	25 5/8"	1195	113,45

6722

Bağ Makası (Hafif Tip)  
Pruning Shears (Light)



Alüminyum gövde, Daldırma PVC izoleli  
Aluminum forged body, PVC dipped

KOD CODE	L mm	L inch	g	TL/Ad.
6722 27 0220	220	8 5/8"	240	85,25

8011

Teşhir Panosu  
Display

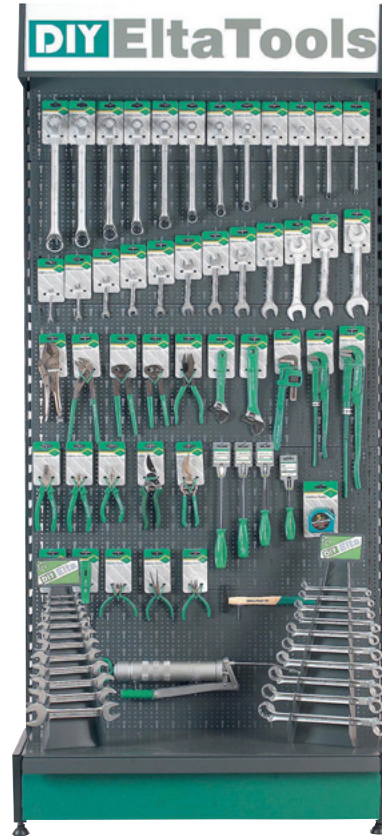

Sacdan imal edilmiş, Fırın boya  
Made from metal sheet, Electrostatic paint

KOD CODE	SIZE mm	Cinsi	g	TL/Ad.
8011 31 6001	500x1000x2250	Boş	14000	908,25

11

Çim Kesme Makası (Düz Ağız)  
Grass Shears (Straight)



KOD CODE	L mm	L inch	g	TL/Ad.
6730 27 0550	550	21 5/8"	915	69,85

# 12

## *Yedek Parçalar* *Spare Parts*



*Yedek Parçalar* Spare Parts

**Kurbağacak Anahtar ve Ayarlı Montaj Anahtarları Yedek Parçalar**  
*Adjustable Wrench, Spare Parts*

	KOD CODE	L mm	L inch	g	TL/Ad.	
<b>Somun</b> <i>Nut</i>	0600 01 0206	160	6"	5	10	4,60
	0600 01 0208	208	8"	10	10	5,45
	0600 01 0210	260	10"	10	10	7,35
	0600 01 0212	308	12"	20	10	10,00
	0600 01 0215	388	15"	65	10	14,55
	<b>Vida</b> <i>Bolt</i>	0600 01 0306	160	6"	3	10
0600 01 0308		208	8"	5	10	1,70
0600 01 0310		260	10"	5	10	2,10
0600 01 0312		308	12"	10	10	2,85
0600 01 0315		388	15"	20	10	3,65
<b>Yay</b> <i>Spring</i>		0600 01 0406	160	6"	1	10
	0600 01 0408	208	8"	1	10	0,80
	0600 01 0410	260	10"	1	10	0,80
	0600 01 0412	308	12"	1	10	0,80
	0600 01 0415	388	15"	3	10	0,80

2100

**Stilson Anahtar Yedek Parçaları**  
*Stilson Wrench Spare Part*

	KOD CODE	ÖLÇÜ FOR	g	TL/Ad.		
<b>Çene</b> <i>Jaw</i>	2100 10 0108	8"	80	5	28,60	
	2100 10 0110	10"	180	5	42,45	
	2100 10 0112	12"	320	5	47,35	
	2100 10 0114	14"	400	5	57,10	
	2100 10 0118	18"	575	5	76,85	
	2100 10 0124	24"	980	5	110,15	
	<b>Bağlantı Parçası</b> <i>Connection Part</i>	2100 10 0208	8"	60	5	43,95
		2100 10 0210	10"	95	5	65,25
		2100 10 0212	12"	100	5	71,50
		2100 10 0214	14"	195	5	86,35
2100 10 0218		18"	345	5	99,00	
2100 10 0224		24"	445	5	148,00	
<b>Somun</b> <i>Nut</i>	2100 10 0308	8"	10	5	21,25	
	2100 10 0310	10"	30	5	23,40	
	2100 10 0312	12"	25	5	24,50	
	2100 10 0314	14"	45	5	27,30	
	2100 10 0318	18"	75	5	37,80	
	2100 10 0324	24"	105	5	41,30	

2350

**Demir Kesme Makası Yedek**  
*Bolt Cutters Spare Part*

	KOD CODE	ÖLÇÜ SIZE	KAPASİTE CAPACITY Ø mm	g	TL/Ad.	
<b>Çene</b> <i>Jaw</i>	2350 27 0118	18"	6 - 8	850	1	134,05
	2350 27 0124	24"	8 - 10	870	1	153,65
	2350 27 0130	30"	9 - 13	1250	1	272,05
	2350 27 0136	36"	11 - 16	1850	1	502,35

2110

**Ağır Tip Boru Anahtarları Yedek Parçaları**  
*Pipe Wrench, Heavy Duty Spare Parts*

	KOD CODE	ÖLÇÜ FOR	g	TL/Ad.		
<b>Çene</b> <i>Jaw</i>	2110 10 0108	8"	100	5	42,70	
	2110 10 0110	10"	205	5	55,75	
	2110 10 0112	12"	235	5	68,85	
	2110 10 0114	14"	400	5	80,70	
	2110 10 0118	18"	675	5	125,90	
	2110 10 0124	24"	900	5	195,25	
	2110 10 0136	36"	1820	5	372,00	
	2110 10 0148	48"	3410	5	545,50	
	<b>Somun</b> <i>Nut</i>	2110 10 0308	8"	10	5	15,20
		2110 10 0310	10"	25	5	16,50
		2110 10 0312	12"	35	5	18,35
		2110 10 0314	14"	40	5	18,60
		2110 10 0318	18"	65	5	26,50
		2110 10 0324	24"	115	5	39,85
2110 10 0336		36"	230	5	74,45	
2110 10 0348		48"	305	5	116,95	
<b>Alt Çene ve Pim</b> <i>Lower Jaw and Pin</i>		2110 10 0408	8"	15	5	51,00
		2110 10 0410	10"	40	5	56,00
	2110 10 0412	12"	60	5	63,00	
	2110 10 0414	14"	60	5	63,00	
	2110 10 0418	18"	90	5	65,20	
	2110 10 0424	24"	125	5	74,40	
	2110 10 0436	36"	225	5	119,50	
	2110 10 0448	48"	285	5	160,40	

2201

**Maşalı Boru Anahtarları Yedek Somun**  
*Nut*

	KOD CODE	ÖLÇÜ FOR	g	TL/Ad.	
<b>Maşalı Boru Anahtarları Yedek Somun</b> <i>Nut</i>	2201 10 0110	1"	25	10	4,85
	2201 10 0115	1 1/2"	40	10	6,10
	2201 10 0120	2"	60	10	8,10
	2201 10 0130	3"	75	10	10,90
	2201 10 0140	4"	75	10	12,85

5850

**Plastik Çekiç Yedek Başlık**  
*Plastic Hammer Spare Head*

	KOD CODE	ØD mm	g	TL/Ad.	
<b>Plastik Çekiç Yedek Başlık</b> <i>Plastic Hammer Spare Head</i>	5850 25 0130	30	35	10	11,65
	5850 25 0140	40	70	10	16,70
	5850 25 0150	50	120	10	24,00

6400

**Keser Sapı / Adze Handle**

	KOD CODE	L mm	g	TL/Ad.	
<b>Keser Sapı / Adze Handle</b>	6400 25 0001	400	140	10	9,05

## 5800

### Tesfiyeci Çekiç Yedek Sapı (Kamalı) Hammer Handle (With Pin)



KOD CODE	L mm	g	g	TL/Ad.
5800 25 0001	260	100	60	10 11,45
5800 25 0002	280	200	60	10 11,50
5800 25 0003	300	300	95	10 12,90
5800 25 0005	320	500	100	10 14,45
5800 25 0010	360	1000	165	10 18,25
5800 25 0015	380	1500	185	10 21,10
5800 25 0020	400	2000	205	10 22,75

## 5865

### Madırğa Sap (Kamalı) Mallet Handle (With Pin)



KOD CODE	L mm	g	g	TL/Ad.
5865 25 0001	260	1000	210	10 14,20
5865 25 0002	280	1500	270	10 15,60

## 6410

### Nacak Sap (Kamalı) Hatchet Handle (With Pin)



KOD CODE	L mm	g	g	TL/Ad.
6410 25 0001	380	800	250	10 40,00

## 03755

### Kablo Sıyrıcı Yedek Bıçağı Cable Strippers Spare Blade



KOD CODE	ÖLÇÜ SIZE	g	TL/Ad.
03755 50 625	Tek 6/300 Çok 1,5/25	25	5 13,80

## 06375

### Ayarlı Yağ Filtresi Sökeceği Yedek Kelepçe Adjustable Slot Type Oil Filter Wrench Spare Clamp



KOD CODE	Ø mm	g	TL/Ad.
06375 50 010	100	20	5 7,50

## 6230

### Gres Pompası Yedek Ucu Grease Gun Nozzle



500cc  
300cc

KOD CODE	L mm	Ø mm	g	TL/Ad.
6230 26 2500	38	15	31	10 6,95

### Hortumu

### Hose for Grease Gun



500cc  
300cc

KOD CODE	Ø mm	L mm	g	TL/Ad.
6230 26 3300	8	300	34	10 9,10
6230 26 3500	12	300	102	10 16,75

## 05898

### HSS Testere Laması Hacksaw Blade HSS



KOD CODE	ÖLÇÜ SIZE	g	TL/Ad.
05898 50 283	13x0.65x18	20	100 10,65

## 05899

### Bimetal Testere Laması Hacksaw Blade Bimetal



KOD CODE	ÖLÇÜ SIZE	g	TL/Ad.
05899 50 283	13x0.65x18	20	100 13,15

## 6735

### Dal Budama Testeresi Yedek Bıçak Spare Blade for Pruning Saw



KOD CODE	L mm	g	TL/Ad.
6735 27 1300	300	60	5 73,90

## 06765

### Plastik Boru Kesme Makası Yedek Bıçağı Plastic Pipe Cutter Spare Blade



KOD CODE	Ø mm	g	TL/Ad.
06765 50 042	42	73	5 161,50
06765 50 063	63	105	5 300,00

## 6850

Mini Boru Kesici Bıçağı / Blade For Mini Tube Cutter  
Standart Boru Kesici Bıçağı / Blade For Standard Tube Cutter  
Teleskopik Boru Kesici Bıçağı / Blade For Telescopic Tube Cutter



KOD CODE	ÖLÇÜ SIZE	g	TL/Ad.
6850 28 1322	1/4" - 1 3/8"	5	10

## 7010-7020

Standart Çektirme Yedek Parçaları  
Spare Parts For Standard Pullers

Uzatma Parçası / Connection Part, Extention



KOD CODE	L mm	KULLANILAN ÇEKTİRME FOR	g	TL/Ad.
7010 29 2033	200	8x10 - 12x10	415	1
7010 29 3033	300	16x15 - 20x15	890	1
7010 29 4033	400	25x20 - 35x20 37x20 - 52x20	2350	1

Kol / Arm



KOD CODE	ÖLÇÜ SIZE	g	TL/Ad.
7010 29 0822	8x10 - 12x10	110	1
7010 29 1622	16x15 - 20x15	330	1
7010 29 2522	25x20 - 35x20 52x20 - 37x20	775	1

Bağlantı Parçası / Connection Part



KOD CODE	ÖLÇÜ SIZE	g	TL/Ad.
7010 29 0833	8x10 - 12x10	160	1
7010 29 1633	16x15 - 20x15	325	1
7010 29 2533	25x20 - 35x20 52x20 - 37x20	930	1

Mil / Spindle



KOD CODE	ÖLÇÜ SIZE	g	TL/Ad.
7010 29 0844	8x10 - 12x10	185	1
7010 29 1644	16x15 - 20x15	555	1
7010 29 2544	25x20	1400	1
7010 29 3544	35x20 - 37x20	2185	1
7010 29 5244	52x20	3210	1

## 7070-7080

S Tipi Çektirme Yedek Parçaları  
Spare Parts For S Type Puller

Kol / Arm



KOD CODE	KULLANILAN ÇEKTİRME FOR	g	TL/Ad.
7070 29 2022	20x13	405	1

Mil / Spindle



KOD CODE	ÖLÇÜ SIZE	g	TL/Ad.
7070 29 2044	20x13	520	1

## 6865

Profesyonel Boru Kesici Bıçağı  
Blade For Professional Tube Cutter



KOD CODE	ÖLÇÜ SIZE	g	TL/Ad.
6865 28 0150	1/8" - 2"	30	5

## 7030-7040

Master Çektirme Yedek Parçaları / Spare Parts For Master Puller

Kol / Arm



KOD CODE	KULLANILAN ÇEKTİRME FOR	g	TL/Ad.
7030 29 0822	8x8	110	1
7030 29 1222	12x12	215	1
7030 29 1622	16x16	345	1
7030 29 2322	23x20	580	1

Mil / Spindle



KOD CODE	ÖLÇÜ SIZE	g	TL/Ad.
7030 29 0844	8x8	180	1
7030 29 1244	12x12	360	1
7030 29 1644	16x16	680	1
7030 29 2344	23x20	1230	1

## 7050-7060

Batarya Çektirme Yedek Parçaları  
Spare Parts For Battery Pullers

Kol / Arm



KOD CODE	KULLANILAN ÇEKTİRME FOR	g	TL/Ad.
7050 29 0422	6x4	40	1
7050 29 0622	6x6	50	1
7050 29 0822	8x8	110	1

Mil / Spindle



KOD CODE	ÖLÇÜ SIZE	g	TL/Ad.
7050 29 0444	6x4	95	1
7050 29 0644	6x6	105	1
7050 29 0844	8x8	200	1

## 7090-7100

Üniversal Çektirme Yedek Parçaları  
Spare Parts For Universal Puller

Kol / Arm



KOD CODE	KULLANILAN ÇEKTİRME FOR	g	TL/Ad.
7090 29 2322	22x22	690	1

Mil / Spindle



KOD CODE	ÖLÇÜ SIZE	g	TL/Ad.
7090 29 2244	22x22	565	1

13

# Ticari Teşhir Ürünleri Commercial Display Products

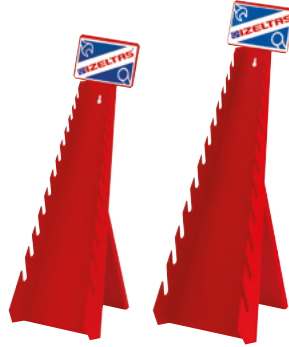

**Ticari Teşhir Ürünleri**  
Commercial Display Products

1113

1/2" Lokma Anahtar Sehpası  
Display Frame for Sockets



1/2"

KOD CODE	ÖLÇÜ SIZE mm	g	TL/Ad.
1113 31 6100	175x360x605	5800	1 153,45

7010

Çektirme Sehpası  
Display Frame For Pullers



KOD CODE	İÇERİK CONTENTS	g	TL/Ad.
7010 31 6105	Boş - Empty	2000	1 67,30

2350

Demir Kesme Makası Sehpası  
Display Frame for Bolt Cutters

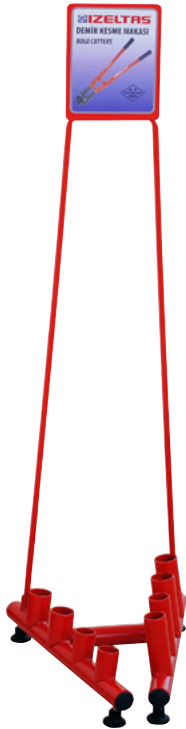

7300

İşkence Sehpası  
Display Frame for Screw Clamps



KOD CODE	İÇERİK CONTENTS	g	TL/Ad.
2350 31 6104	Boş - Empty	7400	1 285,00

KOD CODE	ÖLÇÜ SIZE mm	g	TL/Ad.
7300 31 6150	100x520x1420	8000	1 348,75



## 8001 - 8002

### Çatal ve Yıldız Anahtar Sehpası Display Frame For Wrenches



Sacdan imal edilmiş, Fırın boya  
Made from metal sheet, Electrostatic paint

KOD CODE	ÖLÇÜ SIZE mm	g	İÇERİK CONTENTS	TL/Ad.
8001 31 6012	160x500	800	Çatal / Open Jaw	1 45,15
8002 31 6012	170x560	1000	Yıldız / Ring	1 56,35

## 8004

### Dövme Çelik Mengene Sehpası Forged Steel Vice Frame



KOD CODE	İÇERİK CONTENTS	g	TL/Ad.
8004 31 6004	Boş - Empty	8000	1 432,40

## 8015

### Tekerlekli Üçgen Teşhir Standı Triangular Display Frame

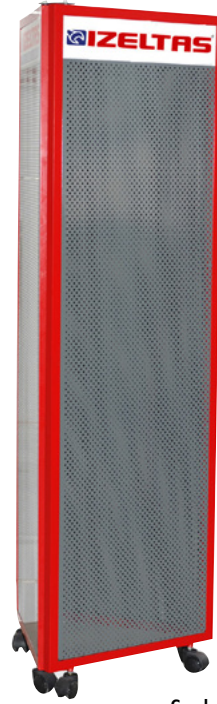

Sacdan imal edilmiş, Fırın boya  
Made from metal sheet, Electrostatic paint

KOD CODE	ÖLÇÜ SIZE mm	g	TL/Ad.
8015 31 6001	520x1670	29500	1 613,20



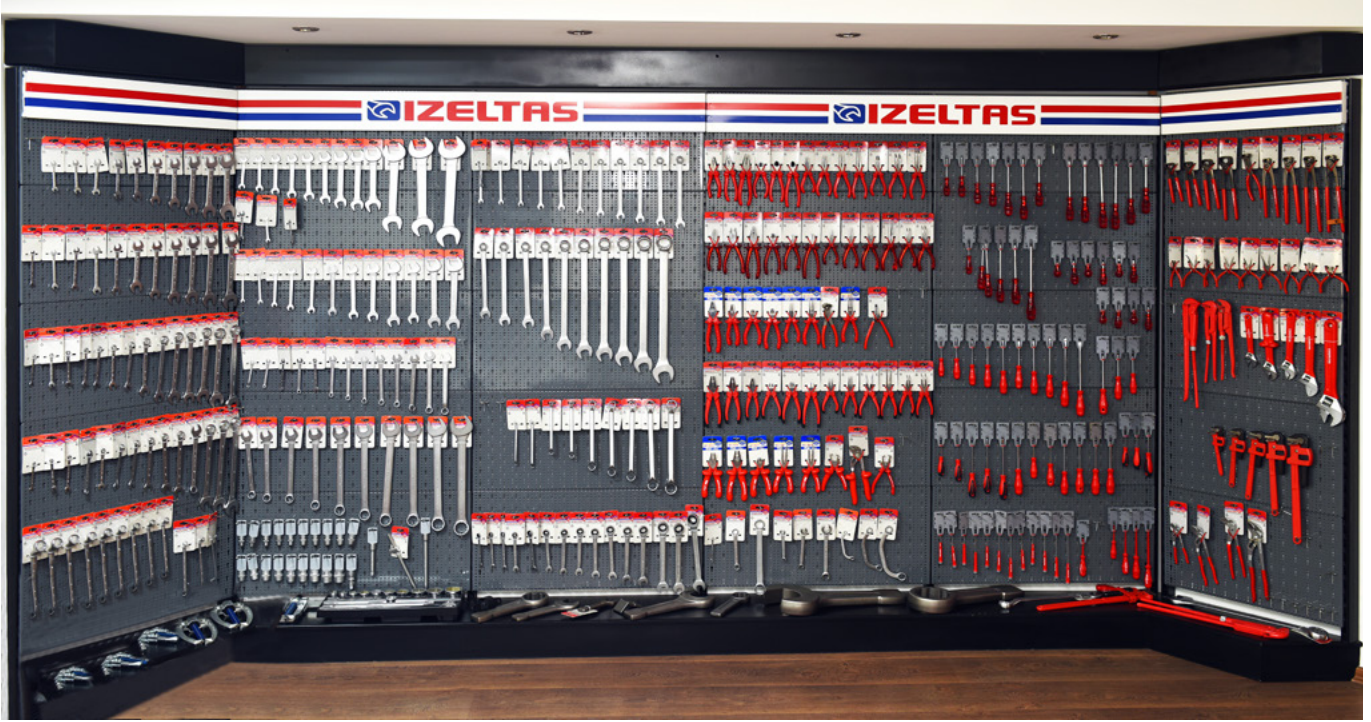

İzeltaş El Aletleri Teşhir Panosu, satış noktaları için özel olarak dizayn edilmiştir. Kolayca monte edilebilen 19 ana parçadan oluşan panonun derinliği 46 cm, genişliği 100 cm, yüksekliği 220 cm'dir. Etkili görünümü ve tüm ürünleri bir arada sergileme özelliği yanında, perakende satışlarda seçme kolaylığı sağlaması bakımından da önem taşımaktadır.

İzeltaş's Product Exhibition Board has been specially designed for selling points. These boards have been formed from easily mountable 19 main parts and have the dimensions as following, width 46 cm, length 100 cm and height 220 cm.

Board features an impressive looking and displays the products all together, which makes it easy to choose desired tools during retail selling activities.

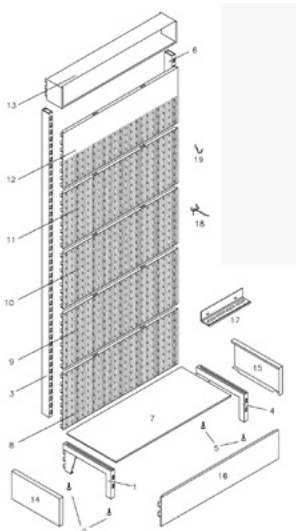

#### Montaj Sırası / Montage Order

1. Ayak / Stand right leg
2. Plastik ayak / Plastic leg
3. Kolon / Stand right column
4. Ayak / Stand left leg
5. Plastik ayak / Plastic leg
6. Kolon / Stand left column
7. Raf / Shelf
8. Delikli pano / Drilled panel
9. Delikli pano / Drilled panel
10. Delikli pano / Drilled panel
11. Delikli pano / Drilled panel
12. Yarım delikli pano / Half - drilled panel
13. Aydınlatma alınlığı / Illumination panel
14. Yan kapak / Side cover
15. Yan kapak / Side cover
16. Ön kapak / Front cover
17. Tornavida askısı / Screwdriver hanger
18. Büyük askı / Long hanger
19. Küçük askı / Short hanger

#### Büyük Pano Display Panel (Empty)

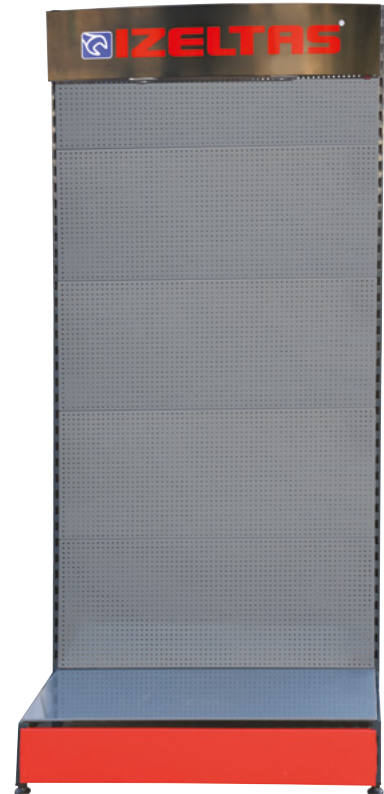

KOD CODE	ÖLÇÜ SIZE mm	Cinsi	g	TL/Ad.
8010 31 6001	460x1000x2200	Boş/Empty	43000	1 916,60

14

# Stoklarla Sınırlı Ürünler

## Limited Items



**Stoklarla sınırlı ürünler**  
Limited Items

0132

İki Ağız Anahtar Uzun Boy MASTER (mm)  
Double Ended Open Jaw Wrench MASTER  
Long Pattern (mm)

TS ISO 10102  
DIN 3110



Saten krom yüzeyli, Krom vanadyum, Krom kaplı  
Satin chrom finish, Chrom vanadium, Chrom plated

KOD CODE	mm	L mm	a1 mm	b1 mm	b2 mm	g	TL/Ad.
★0132 01 0607	6x7	125	3.5	14	16	20	10 12,85
★0132 01 0809	8x9	140	4	18	20	30	10 13,30
★0132 01 1011	10x11	155	4.5	22	24	45	10 14,75
★0132 01 1415	14x15	188	5.5	30	32	85	10 18,10
★0132 01 1617	16x17	205	6.2	34	36	115	10 19,95
★0132 01 1819	18x19	220	7	38	40	160	10 21,40
★0132 01 2022	20x22	235	7.5	42	46	195	5 24,80
★0132 01 2123	21x23	248	8.3	44	48	235	5 25,35
★0132 01 2426	24x26	265	8.8	50	54	300	5 29,80
★0132 01 2528	25x28	282	9.3	52	57.5	390	5 33,40
★0132 01 2732	27x32	300	9.8	56	65.5	460	5 41,70

İki Ağız Anahtar Takımı Uzun Boy MASTER (mm)  
Double Ended Open Jaw Wrench  
MASTER Long Pattern Set (mm)

TS

KOD CODE	İÇERİK CONTENTS	g	TL/Ad.
★0132 00 2112	6x7 - 8x9 - 10x11 12x13 - 14x15 - 16x17 18x19 - 20x22 - 21x23 24x26 - 25x28 - 27x32	2315	12 270,05

0220

İki Ağız Taçlı Anahtar (mm)  
Double Ended Open Jaw Wrench (mm)



Krom vanadyum, Krom kaplı  
Chrom vanadium, Chrom plated

KOD CODE	mm	L mm	a1 mm	b1 mm	b2 mm	g	TL/Ad.
★0220 01 1722	17x22	195	7.5	35.5	44.5	120	10 20,05

0322

Kombine Anahtar Kısa Boy MASTER (mm)  
Combination Wrench MASTER  
Short Pattern (mm)

TS 3794  
TS ISO 7738 Form A  
DIN 3113



Saten krom yüzeyli, Krom vanadyum, Krom kaplı  
Satin chrom finish, Chrom vanadium, Chrom plated

KOD CODE	mm	L mm	a1 mm	a2 mm	b1 mm	bD mm	g	TL/Ad.
★0322 02 0006	6	100	3.4	5.1	14	10	15	10 12,25
★0322 02 0007	7	110	3.6	5.5	16	11	20	10 13,05
★0322 02 0008	8	120	3.8	5.9	18	13	25	10 14,15
★0322 02 0009	9	130	4	6.3	20	14	30	10 14,55
★0322 02 0010	10	140	4.3	6.9	22	15.5	40	10 16,40
★0322 02 0011	11	150	4.5	7.3	24	17	45	10 16,90
★0322 02 0012	12	160	4.9	7.7	26	18.5	55	10 18,00
★0322 02 0014	14	180	5.5	8.7	30	21.5	75	10 19,90
★0322 02 0015	15	190	5.8	9.1	32	22.5	90	10 21,30
★0322 02 0016	16	200	6.1	9.6	34	24	105	10 22,85
★0322 02 0017	17	210	6.4	9.8	36	25.5	120	10 24,40
★0322 02 0018	18	220	6.8	10.4	38	27	145	10 27,20
★0322 02 0019	19	232	7	11	40	28.5	170	10 28,60
★0322 02 0020	20	240	7.2	11.4	42	30	195	10 29,10
★0322 02 0021	21	250	7.4	12	44	31.5	190	10 33,85
★0322 02 0022	22	260	8.2	12.6	46	33	275	10 38,75
★0322 02 0024	24	280	8.5	13.6	50	36.5	320	5 42,65
★0322 02 0025	25	290	8.8	14	52	39	340	5 46,90
★0322 02 0026	26	300	9	14.8	54	41	400	5 51,60
★0322 02 0030	30	340	10.3	16	61.5	44	505	5 61,90

0432

Yıldız İki Ağız Anahtar MASTER (mm)  
Double Ended Ring Wrench (mm) MASTER

TS 3794  
TS ISO 10104 Form B  
DIN 838

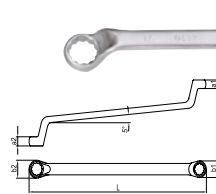

Saten krom yüzeyli, Krom vanadyum, Krom kaplı  
Satin chrom finish, Chrom vanadium, Chrom plated

KOD CODE	mm	L mm	a1 mm	a2 mm	b1 mm	b2 mm	g	TL/Ad.
★0432 03 0607	6x7	176	5.6	6	10	11.5	55	10 20,45
★0432 03 1011	10x11	206	7.3	7.6	15.5	17	105	10 23,00
★0432 03 1819	18x19	271	12	12.5	27.5	29	270	10 37,05
★0432 03 2123	21x23	311	13.1	14	32	35	410	5 46,55
★0432 03 2426	24x26	331	14.2	14.6	36.5	39.5	495	5 54,20
★0432 03 2528	25x28	352	14.5	15.5	38	42.5	550	5 59,40
★0432 03 2732	27x32	371	15	16.7	40.5	47.5	660	5 65,30

## 0360

### XL Ekstra Uzun Kombine Anahtar (mm) Extra Long (XL) Combination Wrench (mm)

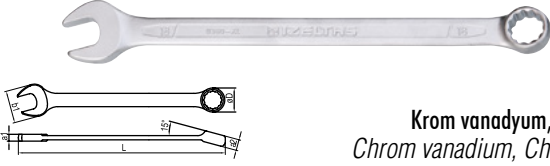

Krom vanadyum, Krom kaplı  
Chrom vanadium, Chrom plated

KOD CODE	mm	L mm	a1 mm	a2 mm	b1 mm	øD mm	g	TL/Ad.
★0360 02 0008	8	170	4.5	7.5	20.3	13.2	45	10, 16,65
★0360 02 0009	9	180	4.5	8	22.4	14.6	55	10, 16,90
★0360 02 0010	10	190	5	8.5	24.4	16	60	10, 18,75
★0360 02 0011	11	200	5.5	9	26.4	17.2	75	10, 19,80
★0360 02 0012	12	210	6	9.5	28.4	19	90	10, 19,80
★0360 02 0013	13	225	6.5	10	30.5	20	110	10, 22,30
★0360 02 0014	14	235	7	11	32.5	21.8	120	10, 23,20
★0360 02 0015	15	250	7.5	12	34.5	23	150	10, 24,70
★0360 02 0016	16	265	8	13	36.4	24.5	175	10, 25,05
★0360 02 0017	17	280	8.5	14	38.4	26.5	210	10, 28,40
★0360 02 0018	18	295	9	15	40.6	28	240	10, 30,80
★0360 02 0019	19	310	9.5	16	42.6	29.5	280	10, 33,35
★0360 02 0020	20	310	9.5	16	44.5	31	265	10, 35,60
★0360 02 0021	21	340	10	17	46.6	33	370	10, 37,85
★0360 02 0022	22	350	11	18	48.7	34.5	410	10, 44,95
★0360 02 0024	24	400	12	19	52.7	37.5	535	5, 55,00
★0360 02 0027	27	450	13	20	58.9	42	680	5, 64,75
★0360 02 0030	30	480	14	21	64.8	47	870	1, 74,30
★0360 02 0032	32	500	15	22	67	49.5	1000	1, 88,60
★0360 02 0034	34	520	15	23	70	53	1100	1, 90,35
★0360 02 0041	41	600	16	26	86	63.5	1700	1, 143,15
★0360 02 0046	46	640	17.4	27	96	70.9	2230	1, 166,80

### XL Ekstra Uzun Kombine Anahtar Takımı (mm) Extra Long (XL) Combination Wrench, Set (mm)

KOD CODE	İÇERİK CONTENTS	g	TL/Ad.
★0360 00 2108	8 - 9 - 10 - 11 - 12 - 13 - 17 - 19	915	8, 175,95

## 0600

### Kurbağacık Anahtar Süper İzole Adjustable Wrench Super Insulated



Krom vanadyum, Krom kaplı, Kalın PVC izoleli  
Chrom vanadium, Chrom plated, Triple PVC insulated



TS 3796  
DIN 3117

KOD CODE	L mm	L inch	a mm	g	TL/Ad.
★0600 01 0010	260	10"	28	480	5, 123,75

## 0600

### Kurbağacık Anahtar Armatür Adjustable Wrench for Plumbers



TS 3796  
DIN 3117



Krom vanadyum, Krom kaplı, PVC izoleli  
Chrom vanadium, Chrom plated, PVC insulated

KOD CODE	L mm	L inch	a mm	g	TL/Ad.
★0600 01 2012	308	12"	34	660	5, 150,50

## 1507

### 1/4" Mafsallı Kol Flexible Handle

TS ISO 3315  
DIN 3122



## 1/4"

Krom vanadyum, Krom kaplı, Polisajlı  
Chrom vanadium, Chrom plated, Polished

KOD CODE	L mm	g	TL/Ad.
★1507 06 0130	130	85	5, 48,25

## 1207

### 1/4" Sekiz Köşe Lokma Anahtar (mm) Socket Wrench 8 Points (mm)

TS ISO 2725 -1  
DIN 3124

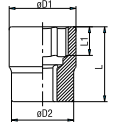

## 1/4"

Krom vanadyum, Krom kaplı, Polisajlı  
Chrom vanadium, Chrom plated, Polished

KOD CODE	mm	ø D1 mm	ø D2 mm	L mm	g	TL/Ad.
★1207 06 8008	8	12.2	12.2	24.5	15	10, 5,80
★1207 06 8010	10	14.7	14.7	24.5	25	10, 6,80

1510

3/8" Mafsallı Kol  
Flexible Handle

TS ISO 3315  
DIN 3122



3/8"

Krom vanadyum, Krom kaplı, Polislı  
Chrom vanadium, Chrom plated, Polished

KOD CODE	L mm	g	TL/Ad.
★1510 06 0215	215	310	5 65,80

1845

Mafsallı Buji Lokma  
Spark Plug Wrench with Universal Joint



Özel alaşım çelik, Krom kaplı  
Special steel, Chrom plated

KOD CODE	mm	L mm	g	TL/Ad.
★1845 08 0160	16	500	525	10 236,85
★1845 08 0208	20.8	520	960	10 288,30

1857

T Kol Lokma  
T - Handle Hexagonal Socket Wrench



Özel alaşım çelik, Krom kaplı  
Special steel, Chrom plated

KOD CODE	mm	L mm	g	TL/Ad.
★1857 08 0010	10	240	260	10 94,40
★1857 08 0013	13	260	315	10 97,45
★1857 08 0017	17	280	470	10 124,75
★1857 08 0019	19	300	590	10 129,45

1513

1/2" Havalı Lokma Ara Kol  
Impact Socket Extension Bar



1/2"

Krom molibden, Fosfat kaplamalı  
Chrom molybdenum, Phosphate finish

KOD CODE	L mm	g	TL/Ad.
★1513 06 7250	250	450	5 97,90

1113

1/2" Alaşım Jant Lokma Takımı (7 Parca, mm)  
Combination Lug Nut Socket Set (7 Pcs, mm)



1/2"

KOD CODE	LOKMA LAR Sockets	g	TL/Ad.
★1113 00 9007	17 - 19 - 21 - 22 23 - 24 - 27	2250	7 428,95

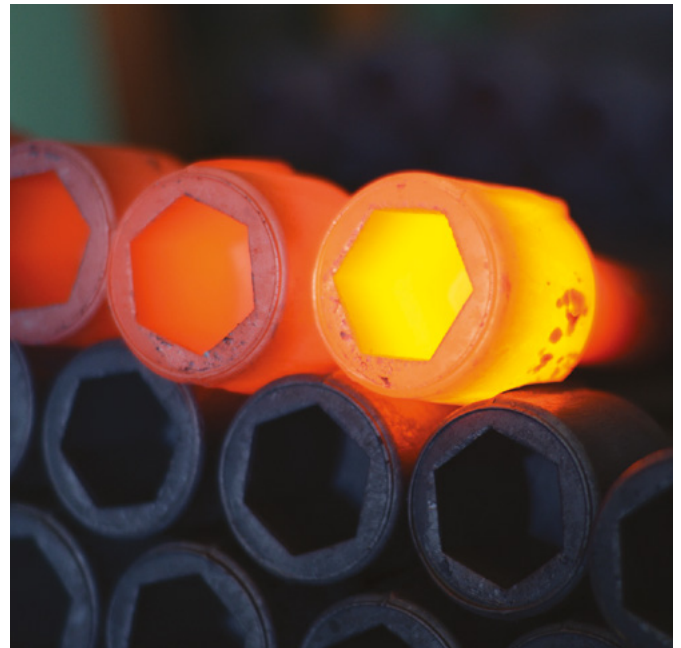

**1113**

1/2" Manyetik Lokma (mm)  
Socket Wrench 6 Points (mm)

TS ISO 2725 -1  
DIN 3124

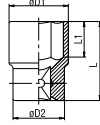
**1/2"**

Krom vanadyum, Krom kaplı  
Chrom vanadium, Chrom plated

KOD CODE	mm	ø D1 mm	ø D2 mm	L mm	g	TL/Ad.
★1113 06 3008	8	13.2	21.8	38	55	10, 14,35
★1113 06 3010	10	15	23.3	38	55	10, 20,90
★1113 06 3012	12	17.8	23.3	38	60	10, 20,90
★1113 06 3014	14	20.4	23.3	38	65	10, 25,50

**1113**

1/2" Manyetik Lokma Torx® Uç  
Magnetic Socket Wrench 6 Points - Torx® Bits

**1/2"**

Krom vanadyum, Krom kaplı  
Chrom vanadium, Chrom plated

KOD CODE	Torx® Uçlar Torx® Bits	Kullanılan Lokma For Dimensions	g	TL/Ad.
★1113 06 3120	T20	<b>8mm Manyetik Lokma Magnetic Socket Wrench</b>	9	10, 8,85
★1113 06 3125	T25		9	10, 8,85
★1113 06 3127	T27		9	10, 8,85
★1113 06 3130	T30		9.4	10, 8,85
★1113 06 3140	T40		10.2	10, 8,85
★1113 06 3145	T45		11	10, 10,80
★1113 06 3150	T50	11.7	10, 11,45	
★1113 06 3155	T55	<b>10mm Manyetik Lokma Magnetic Socket Wrench</b>	18.2	10, 12,35
★1113 06 3160	T60	<b>14mm Manyetik Lokma Magnetic Socket Wrench</b>	31.6	10, 13,35

**1113**

1/2" Manyetik Lokma Allen Uç (mm)  
Magnetic Socket Wrench 6 Points (mm) - Hex Bits

**1/2"**

Krom vanadyum, Krom kaplı  
Chrom vanadium, Chrom plated

KOD CODE	ALLEN UÇLAR HEX BITS	Kullanılan Lokma For Dimensions	g	TL/Ad.
★1113 06 3205	5mm	<b>8mm Manyetik Lokma Magnetic Socket Wrench</b>	12	10, 7,75
★1113 06 3206	6mm	<b>8mm Manyetik Lokma Magnetic Socket Wrench</b>	139	10, 7,75
★1113 06 3207	7mm		14	10, 7,75
★1113 06 3208	8mm		14	10, 8,50
★1113 06 3210	10mm		<b>10mm Manyetik Lokma Magnetic Socket Wrench</b>	24
★1113 06 3212	12mm	<b>12mm Manyetik Lokma Magnetic Socket Wrench</b>	37	10, 11,25
★1113 06 3214	14mm	<b>14mm Manyetik Lokma Magnetic Socket Wrench</b>	42	10, 12,55

**1113**

1/2" Manyetik Lokmalı Uç Takımı (20 Parça)  
Magnetic Hex Bit Sockets Torx® Bit Sockets Set (20 Pcs)



**1/2"**

KOD CODE	İÇERİK CONTENTS	TL/Ad.
★1113 00 3020	<b>Manyetik Lokma (1/2") Magnetic Socket Wrench</b> 8 -10 - 12 - 14 <b>Allen Uç</b> Hex Bit Socket 5-6-7-8-10-12-14 <b>Torx® Uç / Torx® Bits</b> T20 - T25 - T27 -T30 - T40 T45 - T50 - T55 - T60	20, 238,15

1800

**Kovan Anahtar İki Ağız (mm)**  
Double Ended Tubular  
Socket Wrench (mm)

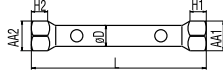
TS ISO 3793  
DIN 896  
TSE



Dikışsız çelik boru, Çinko kaplı  
Seamless steel tube, Zinc plated

KOD CODE	mm	L mm	AA1 mm	AA2 mm	H1 mm	H2 mm	g	TL/Ad.
★1800 07 2123	21x23	165	26.4	28.4	17	19	240	5, 40,85
★1800 07 2426	24x26	180	30.4	32.4	20	22	340	5, 53,00
★1800 07 2528	25x28	200	31.4	34.4	21	24	400	5, 62,40
★1800 07 2732	27x32	200	33.4	38.4	23	26	435	5, 72,60

2200

**Maşalı Boru Anahtarı (45°)**  
Pipe Wrench (45°)



Krom vanadyum, Dişler indüksiyonda sertleştirilmiş, Elektrostatik boyanmış  
Chrom vanadium, Teeth induction hardened, Electrostatically painted

KOD CODE	L mm	mm	ÖLÇÜ SIZE Inch	g	TL/Ad.
★2200 10 0005	255	22	1/2"	385	1, 148,70
★2200 10 0010	335	35	1"	720	1, 176,65
★2200 10 0015	470	46	1 1/2"	1345	1, 249,50
★2200 10 0020	630	65	2"	2470	1, 397,45

2202

**İsveç Tip Maşalı Boru Anahtarı**  
Pipe Wrench, Swedish Pattern

DIN 5234



Krom vanadyum, Dişler indüksiyonda sertleştirilmiş, Elektrostatik boyanmış  
Chrom vanadium, Teeth induction hardened, Electrostatically painted

KOD CODE	L mm	mm	ÖLÇÜ SIZE Inch	g	TL/Ad.
★2202 10 0010	320	40	1"	845	1, 179,60
★2202 10 0015	410	60	1 1/2"	1465	1, 259,65
★2202 10 0020	535	70	2"	2345	1, 400,50

2300

**Zincirli Boru Anahtarı**  
Chain Pipe Wrench Heavy Duty



Özel alaşımli çelik, Dişler indüksiyonda sertleştirilmiş, Elektrostatik boyanmış  
Special steel, Teeth induction hardened, Electrostatically painted

KOD CODE	L mm	A mm	A inch	g	TL/Ad.
★2300 10 0015	350	50	1 1/2"	1345	1, 432,05
★2300 10 0025	685	75	2 1/2"	3500	1, 766,55
★2300 10 0040	940	115	4"	6700	1, 1089,65
★2300 10 0060	1125	165	6"	12600	1, 2160,10
★2300 10 0080	1280	220	8"	17165	1, 2790,95
★2300 10 0120	1625	325	12"	24400	1, 5123,05

2300

**Zincirli Boru Anahtarı Yedek Zinciri**  
Spare Chain



KOD CODE	ÖLÇÜ FOR	g	TL/Ad.
★2300 10 1015	1 1/2"	240	1, 171,15
★2300 10 1025	2 1/2"	400	1, 274,25
★2300 10 1040	4"	600	1, 362,05
★2300 10 1080	8"	3285	1, 1205,50
★2300 10 1120	12"	4625	1, 1791,15

3225

**Kargaburun Eğri Uçlu Ergonomik**  
Nose Pliers (Bent)

TS 60 - TS ISO 5745



Özel alaşımli çelik, Kesici ağızlar indüksiyonda sertleştirilmiş, Krom kaplı  
Special steel, Cutters induction hardened, Chrom plated

KOD CODE	L mm	L inch	MODEL	g	TL/Ad.
★3225 13 5160	160	6 1/4"	ERGONOMİK	140	5, 88,80
★3225 13 5180	180	7 1/8"	ERGONOMİK	160	5, 98,85
★3225 13 5200	200	8"	ERGONOMİK	170	5, 108,80



### 3700

**Süper İzole Yan Keski**  
*Side Cutting Pliers, Super Insulated*

TS 60 - TS ISO 5749  
DIN ISO 5749



△ 1000 V  
E DIN EN 60900:2005



Özel alaşımlı çelik, Kesici ağızlar indüksiyonda sertleştirilmiş,  
Krom kaplı, Kalın PVC izoleli  
*Special steel, Cutters induction hardened,  
Chrom plated, Triple PVC insulated*

KOD CODE	L mm	L inch	g	TL/Ad.
★3700 16 0160	160	6 1/4"	275	5 107,35

### 3310

**Çakma Uçlu Dış Segman Pense (Eğri)**  
*Circlip Pliers, External Insert  
Tips (Bent)*



Krom vanadyum, Siyah oksit kaplı, PVC izoleli  
*Chrom vanadium, Black finish, PVC insulated*

KOD CODE	L mm	ÖLÇÜ	g	TL/Ad.
★3310 12 0170	170	19 - 60	190	5 80,20

### 3320

**Çakma Uçlu İç Segman Pense (Düz)**  
*Circlip Pliers, Inside Driven  
Tips (Flat)*



Krom vanadyum, Siyah oksit kaplı, PVC izoleli  
*Chrom vanadium, Black finish, PVC insulated*

KOD CODE	L mm	ÖLÇÜ	g	TL/Ad.
★3320 12 0140	140	8 - 25	100	5 62,70
★3320 12 0225	225	40 - 100	250	5 82,45

### 3330

**Çakma Uçlu İç Segman Pense (Eğri)**  
*Circlip Pliers, Internal Insert  
Tips (Bent)*



Krom vanadyum, Siyah oksit kaplı, PVC izoleli  
*Chrom vanadium, Black finish, PVC insulated*

KOD CODE	L mm	ÖLÇÜ	g	TL/Ad.
★3330 12 0170	170	19 - 60	185	5 71,00

### 3400

**Sübab Segman Pense**  
*Pliers for Valve Seals*



KOD CODE	L mm	L inch	g	TL/Ad.
★3400 12 0275	275	11"	350	5 176,55

### 3405

**Piston Segman Pense**  
*Piston Ring Pliers*



KOD CODE	L mm	ÖLÇÜ	g	TL/Ad.
★3405 12 0225	265	Ø60 - Ø160	200	5 123,40

### 3415

**Fren Yay Pensesi**  
*Brake Spring Pliers*



Krom vanadyum, Krom kaplı  
*Chrom vanadium, Chrom plated*

KOD CODE	L mm	L inch	g	TL/Ad.
★3415 12 0320	320	13"	430	5 175,00
★3415 12 0525	525	20"	1190	5 405,20

4100

**Kraft Seri Sngs Uzun Dz Ulu Tornovida**  
Screwdriver, Kraft, Flat, Long



**Krom vanadyum, Krom kaplı, Ucu siyah oksit, Selloz asetat saplı**  
Chrom vanadium, Chrom plated and blackened,  
Cellulose acetate handle.

KOD CODE	øDxL1 mm	⊖		L mm	g	TL/Ad.
		a mm	b mm			
★4100 17 3250	3x250	0.5	3	325	40	10
★4100 17 4250	4x250	0.8	4	335	65	10
★4100 17 5300	5x300	1.0	5.5	395	105	10

4110

**Kraft Seri Dz Ulu Topa Tornovida**  
Screwdriver, Kraft, Stubby, Flat

TS 59



**Krom vanadyum, Krom kaplı, Ucu siyah oksit, Selloz asetat saplı**  
Chrom vanadium, Chrom plated and blackened,  
Cellulose acetate handle

KOD CODE	øDxL1 mm	⊖		L mm	g	TL/Ad.
		a mm	b mm			
★ 4110 17 0425	4x25	0.8	4	70	40	5
★ 4110 17 0825	8x25	1.2	8	70	40	5

4551

**Tester Kontrol Kalemi (Dz Ulu)**  
A/C Tester (Flat)

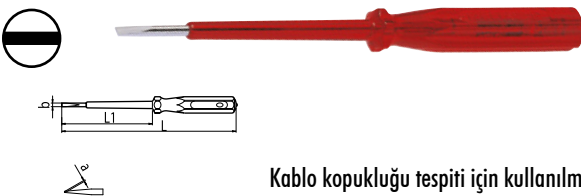

**Kablo kopukluu tespiti iin kullanılmaktadır.**  
is used for the detection of cable break

**Krom vanadyum, Krom kaplı, Őeffa selloz asetat saplı**  
Chrom vanadium, Chrom plated, Transparent cellulose acetate handle

KOD CODE	L mm	⊖		L1 mm	g	TL/Ad.
		a mm	b mm			
★4551 17 0190	190	0.8	4	100	40	10

4101

**Sngs İzoleli Dz Ulu Tornovida**  
Screwdriver, Electrician Blade,  
Insulated, Flat

TS 59



Δ 1000 V  
E DIN EN 60900:2005

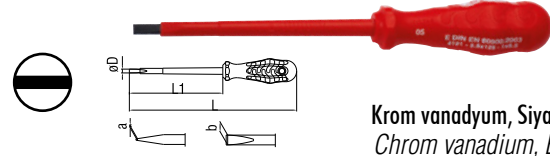

**Krom vanadyum, Siyah oksit kaplı**  
Chrom vanadium, Black finish

KOD CODE	øDxL1 mm	⊖		L mm	g	TL/Ad.
		a mm	b mm			
★4101 17 2575	2.5x75	0.4	2.5	150	25	10
★4101 17 4100	4x100	0.8	4	185	40	10
★4101 17 5512	5.5x125	1	5.5	220	70	10
★4101 17 6515	6.5x150	1.2	6.5	245	90	10

4121

**Sngs İzoleli Yıldız Ulu Tornovida**  
Screwdriver, Electrician Blade,  
Insulated, Phillips

TS 59



Δ 1000 V  
E DIN EN 60900:2005

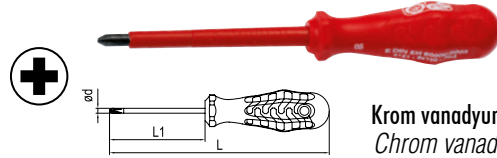

**Krom vanadyum, Siyah oksit kaplı**  
Chrom vanadium, Black finish

KOD CODE	øDxL1 mm	⊕	L mm	g	TL/Ad.
★4121 18 4580	4.5x80	Ph1	165	45	10
★4121 18 6100	6x100	Ph2	195	70	10

4101

**Sngs İzoleli Tornovida Seti (6 para)**  
Screwdriver, Electrician Blade, Insulated Set (6 pcs)



KOD CODE	İERİK CONTENTS	g	TL/Ad.
★4101 00 9106	2.5x75 - 4x100 5.5x125 - 6.5x150 Dz ulu / Flat 4.5x80 - 6x100 Yıldız ulu / Phillips	335	6

4370

Ergonomik Seri Yıldız Uçlu Tornavida  
Screwdriver, Ergonomic, Phillips

TS 59 - 5  
ISO 8764-1

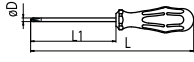

Krom vanadyum, Krom kaplı, Ucu siyah oksit, İki komponent saplı  
Chrome vanadium, Chrom plated and black tip  
Two component handle.

KOD CODE	ØDxL1 mm	+	L mm	g	TL/Ad.
★4370 18 5100	4.5x100	Ph1	185	50	10 18,45
★4370 18 5150	4.5x150	Ph1	235	70	10 20,95
★4370 18 6150	6x150	Ph2	245	150	10 24,55

4772

Süngüsü İzoleli Lokma Uçlu Tornavida  
Nut Spinner, Electrician Blade Insulated

DIN 3125

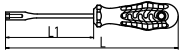

Krom vanadyum, PP saplı  
Chrome vanadium, PP handle

KOD CODE	Ø mm	L mm	L1 mm	g	TL/Ad.
★4772 19 0040	4	220	125	90	10 41,40
★4772 19 0050	5	220	125	90	10 41,40
★4772 19 0055	5.5	220	125	90	10 41,40
★4772 19 0060	6	220	125	90	10 41,40
★4772 19 0070	7	230	125	110	10 44,45
★4772 19 0080	8	230	125	120	10 44,45
★4772 19 0090	9	230	125	125	10 48,00
★4772 19 0100	10	230	125	125	10 48,00
★4772 19 0110	11	230	125	140	10 52,45
★4772 19 0120	12	230	125	145	10 56,30
★4772 19 0130	13	230	125	150	10 57,20
★4772 19 0140	14	230	125	150	10 67,05

Süngüsü İzoleli Lokma Uçlu Tornavida Seti (8 Parça)  
Nut Spinner, Electrician Blade Insulated Set (8 Pcs)

KOD CODE	İÇERİK CONTENTS	g	TL/Ad.
★4772 00 8108	6 - 7 - 8 - 9 - 10 - 11 - 12 - 13	2225	8 392,25

4782

Süngüsü İzoleli Manyetik Bits Tutucu Tornavida  
Screwdriver, Magnetic Bit Holder Insulated



KOD CODE	Ø mm	L mm	L1 mm	g	TL/Ad.
★4782 19 6120	6.3	230	120	115	10 48,60

4920

T Tipi Allen Anahtar (mm)  
Hex Key Wrench T - Handle (mm)



Molibden Vanadyum  
Molybdenum Vanadium

KOD CODE	Ø mm	L mm	L1 mm	g	TL/Ad.
★4920 22 0020	2	110	14	20	5 16,00

5700

Kayış Zimba  
Belt Punch

DIN 7200



Krom vanadyum, Elektrostatik boyanmış  
Chrome vanadium, Electrostatically painted

KOD CODE	ØD mm	L mm	g	TL/Ad.
★5700 24 1023	23	160	305	5 75,30
★5700 24 1024	24	160	320	5 80,20
★5700 24 1027	27	180	415	5 93,75
★5700 24 1029	29	190	465	5 101,10
★5700 24 1030	30	190	475	5 102,50
★5700 24 1032	32	190	500	5 108,40

6415

Nacak  
Hatchet



Özel alaşımli çelik, İndüksiyonda sertleştirilmiş, Elektrostatik boyanmış  
Special steel, Induction hardened, Electrostatically painted

KOD CODE	L mm	L1 mm	L2 mm	g	TL/Ad.
★6415 25 0700	380	140	86	700	965 1 204,25

05888

Çelik Gönye  
Square



Özel alaşımli çelikten yapılmış  
Made from special alloyed steel

KOD CODE	L cm	g	TL/Ad.
★05888 50 030	30	180	82,85

6235

Sübaap Ayar Tornavidası  
Valve Adjustment Spinner



KOD CODE	L mm	g	TL/Ad.
★6235 19 0220	220	90	27,90

6371

Üç Ayaklı Yağ Filtresi Sökeceği  
Oil Filter Hook 3 Arms Pattern



KOD CODE	Ø mm	g	TL/Ad.
★6371 26 3120	63 - 120	700	115,40

06376

Sac Yağ Filtresi Sökeceği  
Oil Filter Wrench



KOD CODE	Ø mm	inch	g	TL/Ad.
★06376 50 108	108	3/8"	240	40,25

06377

Yağ Filtresi Sökeceği Seti (30 Parça)  
30 Pcs. Cup type Oil Filter Wrench Kit



KOD CODE	Ø mm	İÇERİK CONTENTS	g	TL/Ad.
★06377 00 030	65 - 120	28 Parça Karartmalı Sac Yağ Filtresi Sökeceği Ø65 - 108 mm, 28 Pcs Oil Filter Wrench Ø65 - 108 mm, 1 Adet Üç Ayaklı Yağ Filtresi Sökeceği Ø65 120mm, Oil Filter Hooks 3 Arms 120 mm 1 Adet 1/2"Fx3/8"M Adaptör 1Pcs Adapter 1/2"Fx3/8"M	7350	910,55

07420

Basınçlı Hava Hortumu  
Compressed Airtube Reel



KOD CODE	ÖLÇÜ SIZE	BASINÇ BAR	g	TL/Ad.
★07420 50 020	20 m.	10	4760	616,25

**6209**

**Kaportacı Makası Profesyonel**  
*Punch Snip Professional*



Özel alaşımli çelik, Kesici ağızlar induksiyonda sertleştirilmiş  
*Special steel, Cutters induction hardened*

KOD CODE	L mm	L inch	g	TL/Ad.
★6209 27 0270	270	11"	465	5 290,65

**6760**

**Narenciye Makası**  
*Pruning Shears (Citrus)*



Özel alaşımli çelik, Kesici ağızlar induksiyonda sertleştirilmiş, PVC izoleli  
*Special steel, Cutters induction hardened, PVC insulated*

KOD CODE	L mm	L inch	g	TL/Ad.
★6760 27 0125	125	5"	125	5 72,45

**7124**

**Amortisör Çektirme**  
*Puller For Absorber*

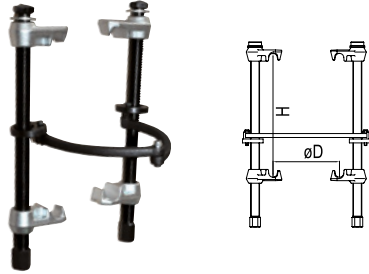

KOD CODE	KAPASİTE CAPACITY	øD mm	H mm	g	TL/Ad.
★7124 29 1118	110x180/240	110	180	2445	1 626,80

**7120**

**İç Rulman Çektirme Pensleri - Model A**  
*Internal Expansion Puller - Model A*

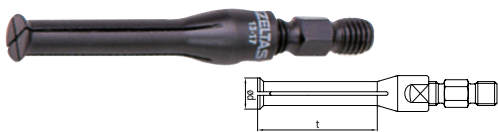

KOD CODE	øD mm	Kullanılan Kol / For	t mm	Adaptör vidası	g	TL/Ad.
★7120 29 4555	45 - 55	60 - 210	100	G3/8	600	1 448,50
★7120 29 5060	50 - 60	60 - 210	100	G3/8	700	1 485,40

**7120**

**İç Rulman Çektirme Pensleri - Model B**  
*Internal Expansion Puller - Model B*



KOD CODE	øD mm	Kullanılan Kol / For	t mm	Adaptör vidası	g	TL/Ad.
★7120 29 4075	40 - 75	60 - 210	100	G3/8	1200	1 618,00

**7125**

**Rotil Çektirme (Çatal)**  
*Ball Joint Separator*



KOD CODE	B mm	H mm	L mm	g	TL/Ad.
★7125 29 0018	18	22	330	785	1 236,40
★7125 29 0031	31	26	330	1060	1 336,25
★7125 29 0035	35	26	350	1150	1 340,10
★7125 29 0045	45	26	350	1155	1 435,55

**7128**

**Rotil Çektirme**  
*Extractor For Ball Joint*



KOD CODE	KAPASİTE CAPACITY mm	g	TL/Ad.
★7128 29 1822	18 - 22	830	1 285,50

**7130**

**Saplama Sökme - Model A**  
*Stud inserter And Remover Cam Type - Model A*



KOD CODE	KAPASİTE CAPACITY mm	øD mm	g	TL/Ad.
★7130 29 1019	10 - 19	19	365	1 285,85
★7130 29 1828	18 - 28	28	410	1 328,10

0341

**Cırcır Kombine Anahtar (mm)**  
Combination Wrench With Ratchet (mm)



Krom vanadyum, Krom kaplı  
Chrom vanadium, Chrom plated

KOD CODE	mm	L mm	a1 mm	a2 mm	øD mm	g	TL/Ad.	
★0341 02 0009	9	150	4.3	6.9	18.6	35	10	42,20
★0341 02 0011	11	165	5.2	7.7	22.2	60	10	44,95
★0341 02 0012	12	170	5.4	8.2	23.2	70	10	46,30
★0341 02 0014	14	190	6	9	27.6	105	10	50,60
★0341 02 0015	15	200	6.5	9.5	28.8	120	10	53,60
★0341 02 0018	18	235	7.9	10.8	33.1	195	10	63,45
★0341 02 0021	21	290	8.5	13	40.3	330	10	71,35

0701

**Çatal Çakma Anahtar (mm)**  
Slugging Open Jaw Wrench (mm)

TS 81  
DIN 133



Krom vanadyum  
Chrom vanadium

KOD CODE	mm	L mm	a1 mm	b mm	g	TL/Ad.	
★0701 05 0024	24	160	15	42	280	1	36,65
★0701 05 0027	27	180	16	45	385	1	45,55
★0701 05 0032	32	190	17	50	530	1	62,80
★0701 05 0042	42	230	19	62	930	1	106,55
★0701 05 0047	47	255	21	72	1320	1	136,95
★0701 05 0075	75	375	31	108	4460	1	416,10
★0701 05 0080	80	405	34	126	6115	1	529,15
★0701 05 0095	95	445	38	140	8160	1	769,65
★0701 05 0100	100	485	44	148	12355	1	1090,95

0751

**Yıldız Çakma Anahtar (mm)**  
Slugging Ring Wrench (mm)

TS 3794  
DIN 7444



Krom vanadyum  
Chrom vanadium

KOD CODE	mm	L mm	a1 mm	b mm	g	TL/Ad.	
★0751 05 0027	27	180	16	46	340	1	47,70
★0751 05 0038	38	205	19	59	540	1	88,65
★0751 05 0042	42	225	20	64	730	1	110,70
★0751 05 0047	47	240	22	73	985	1	127,70
★0751 05 0070	70	330	32	109	2890	1	312,35
★0751 05 0085	85	360	35	123	3635	1	534,30
★0751 05 0090	90	390	40	142	5545	1	657,20
★0751 05 0095	95	390	40	142	5555	1	741,00
★0751 05 0100	100	420	44	152	6880	1	884,35

1801

**Kovan Anahtar İki Ağız (mm)**  
Double Ended Tubular Socket Wrench (mm)

TS ISO 3793  
DIN 896

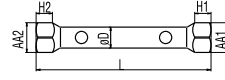

Dikişsiz çelik boru, Çinko kaplı  
Seamless steel tube, Zinc plated.

KOD CODE	mm	L mm	AA1 mm	AA2 mm	H1 mm	H2 mm	øD mm	g	TL/Ad.	
★1801 07 0607	6x7	105	8.6	9.6	7	8	8	25	5	14,30
★1801 07 2022	20x22	165	25.4	27.4	16	18	22	220	5	30,75
★1801 07 2123	21x23	165	26.4	28.4	17	19	24	240	5	34,45
★1801 07 2426	24x26	180	30.4	32.4	20	22	26	340	5	44,65
★1801 07 2528	25x28	200	31.4	34.4	21	24	28	400	5	52,55
★1801 07 2732	27x32	200	33.4	38.4	23	26	30	435	5	61,20

1875

**Ağır Tip Bijon Anahtar İki Ağız Uzun**  
Double Ended Rim Wrench (long)

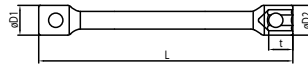

Özel alaşımli çelik, Çinko kaplı  
Special steel, Zinc plated

KOD CODE	mm	L mm	t mm	øD1 mm	øD2 mm	g	g	TL/Ad.	
★1875 09 2224	22x24	400	34.5	34	36	1060	2310	10	72,45
★1875 09 2227	22x27	400	34.5	34	40	1060	2310	10	73,15
★1875 09 2427	24x27	400	34.5	36	40	1060	2310	10	73,50
★1875 09 2730	27x30	400	34.5	40	44	1250	2495	10	78,90
★1875 09 3032	30x32	400	34.5	44	46	1380	2625	10	87,35
★1875 09 3233	32x33	400	34.5	46	47	1430	2675	10	96,95

1514

**1/2" U Kol**  
Speed brace with revolving rubber handle

TS ISO 3315  
DIN 3122



Krom vanadyum, Krom kaplı  
Chrom vanadium, Chrom plated

KOD CODE	L mm	g	TL/Ad.	
★1514 06 4420	420	510	5	70,20

## 1115

1/2" Altı Köşe Lokma Anahtar Takımı (18 Parça, mm)  
Socket Wrench Set 6 Points (18 pcs, mm)



1/2"

KOD CODE	LOKMALAR Sockets	AVADANLIKLAR Accessories	g		TL/ Ad.
★1115 00 6018	10 - 11 - 12 13 - 14 - 15 17 - 19 - 22 24 - 27 - 30 32	1/2" Cırcır Kolu Ratchet Handle 1/2" U Kol Speed Brace with Revolving Rubber Handle 1/2" T Kol Sliding T Handle 1/2" Mafsalsal Universal Joint 1/2" Ara Kol Extension Bar 250 mm	4775	18	525,55

## 1115

1/2" Altı Köşe Lokma Anahtar Takımı (24 Parça, mm)  
Socket Wrench Set 6 Points (24 pcs, mm)



1/2"

KOD CODE	LOKMALAR Sockets	AVADANLIKLAR Accessories	g		TL/ Ad.
★1115 00 6024	10 - 11 - 12 13 - 14 - 15 16 - 17 - 18 19 - 21 - 22 23 - 24 - 27 28 - 30 - 32	1/2" Cırcır Kolu Ratchet Handle 1/2" U Kol Speed Brace with Revolving Rubber Handle 1/2" Mafsalsal Universal Joint 1/2" T Kol Sliding T Handle 1/2" Ara Kol Extension Bar 125 mm 1/2" Ara Kol Extension Bar 250 mm	5400	24	604,10

## 1121

3/4" Altı Köşe Lokma Anahtar (mm)  
Socket Wrench 6 Points (mm)

TS ISO 2725  
DIN 3124

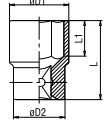

3/4"

Krom vanadyum, Krom kaplı  
Chrom vanadium, Chrom plated

KOD CODE	mm	σ D1 mm	σ D2 mm	L mm	L1 mm	g		TL/ Ad.
★1121 06 0022	22	33	36	52	16	220	5	23,95
★1121 06 0024	24	35	36	52	16	220	5	23,95
★1121 06 0027	27	38	36	52	19	235	5	24,40
★1121 06 0030	30	42	38	54	21	295	5	27,15
★1121 06 0034	34	47	42	58	24	400	5	40,95
★1121 06 0041	41	56	45	64	29	570	5	58,45
★1121 06 0046	46	62	48	68	33	725	1	63,05
★1121 06 0050	50	68	48	72	34	905	1	76,85
★1121 06 0055	55	76	48	76	37	1095	1	91,55
★1121 06 0060	60	80	48	78	38	1275	1	106,30

## 1521

3/4" Ara Kol  
Extension Bar

TS ISO 1174  
DIN 3123



3/4"

Krom vanadyum, Krom kaplı  
Chrom vanadium, Chrom plated

KOD CODE	L mm	g		TL/ Ad.
★1521 06 4200	200	730	5	89,90
★1521 06 4400	400	1380	5	159,80

## 1521

3/4" T Kol  
Sliding T - Handle

TS ISO 3315  
DIN 3122



3/4"

Krom vanadyum, Krom kaplı  
Chrom vanadium, Chrom plated

KOD CODE	L mm	g		TL/ Ad.
★1521 06 4500	500	1490	5	171,85

## 1115

1/2" Altı Köşe Havalı Lokma Anahtar (mm)  
Impact Socket Wrench 6 Points (mm)

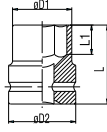

### 1/2"

Krom molibden, Fosfat kaplamalı  
Chrom molybdenum, Phosphate finish

KOD CODE	mm	Ø D1 mm	Ø D2 mm	L mm	g	TL/Ad.
★1115 06 7010	10	17	25	38	70	10
★1115 06 7011	11	18	25	38	70	10
★1115 06 7012	12	19	25	38	70	10
★1115 06 7013	13	20	25	38	70	10
★1115 06 7014	14	22	25	38	75	10
★1115 06 7015	15	23	30	38	110	10
★1115 06 7016	16	24	30	38	110	10
★1115 06 7017	17	26	30	38	115	10
★1115 06 7018	18	27	30	38	115	10
★1115 06 7019	19	28	30	38	120	10
★1115 06 7021	21	30	30	40	125	5
★1115 06 7022	22	32	30	40	145	5
★1115 06 7024	24	34	30	42	150	5
★1115 06 7027	27	38	30	44	175	5

## 1514

1/2" Havalı Lokma Mafsal  
Impact Socket Universal Joint



### 1/2"

Krom molibden, Fosfat kaplamalı  
Chrom molybdenum, Phosphate finish

KOD CODE	L mm	g	TL/Ad.
★1514 06 7065	75	220	5

## 1514

1/2" Havalı Lokma Ara Kol  
Impact Socket Extension Bar



### 1/2"

Krom molibden, Fosfat kaplamalı  
Chrom molybdenum, Phosphate finish

KOD CODE	L mm	g	TL/Ad.
★1514 06 7125	125	275	5
★1514 06 7250	250	450	5

## 1121

3/4" Altı Köşe Havalı Lokma Anahtar (mm)  
Impact Socket Wrench 6 Points (mm)

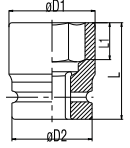

### 3/4"

Krom molibden, Fosfat kaplamalı  
Chrom molybdenum, Phosphate finish

KOD CODE	mm	Ø D1 mm	Ø D2 mm	L mm	L1 mm	g	TL/Ad.
★1121 06 7019	19	32	44	50	12	315	5
★1121 06 7021	21	35	44	50	15	340	5
★1121 06 7022	22	36	44	50	15	345	5
★1121 06 7024	24	38	44	50	16	350	1
★1121 06 7027	27	42	44	53	17	380	1
★1121 06 7030	30	46	44	53	20	410	1
★1121 06 7034	34	51	44	57	22	490	1
★1121 06 7041	41	59	44	58	24	580	1
★1121 06 7046	46	66	44	62	24	720	1

## 1521

3/4" Havalı Lokma Ara Kol  
Impact Socket Extension Bar



### 3/4"

Krom molibden, Fosfat kaplamalı  
Chrom molybdenum, Phosphate finish

KOD CODE	L mm	g	TL/Ad.
★1521 06 7175	175	865	5
★1521 06 7250	250	1155	5
★1521 06 7330	330	1425	5

## 1521

3/4" Havalı Lokma Mafsal  
Impact Socket Universal Joint



### 3/4"

Krom molibden, Fosfat kaplamalı  
Chrom molybdenum, Phosphate finish

KOD CODE	L mm	g	TL/Ad.
★1521 06 7108	108	735	1



### 3303

**Dış Segman Pense (Yaylı Düz)**  
*Circlip Pliers, External (Flat)*

TS 60

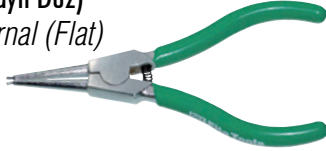

**Krom vanadyum, Krom kaplı, PVC izoleli**  
*Chrom vanadium, Chrom plated, PVC Insulated*

KOD CODE	L mm	⌀	g	□	TL/Ad.
★3303 12 0140	140	10 - 25	90	5	54,65

### 3304

**Dış Segman Pense (Yaylı Eğri)**  
*Circlip Pliers, External (Bent)*

TS 60



**Krom vanadyum, Krom kaplı, PVC izoleli**  
*Chrom vanadium, Chrom plated, PVC Insulated*

KOD CODE	L mm	⌀	g	□	TL/Ad.
★3304 12 0125	125	10 - 25	90	5	61,00
★3304 12 0170	170	19 - 60	160	5	64,35

### 3323

**İç Segman Pensi (Yaysız Düz)**  
*Circlip Pliers Internal (Flat)*

TS 60

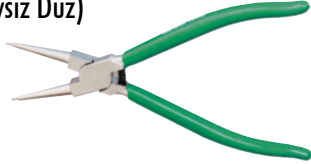

**Krom vanadyum, Krom kaplı, PVC izoleli**  
*Chrom vanadium, Chrom plated, PVC Insulated*

KOD CODE	L mm	⌀	g	□	TL/Ad.
★3323 12 0140	140	8 - 25	90	5	50,25
★3323 12 0230	230	40 - 100	300	5	74,70

### 3324

**İç Segman Pensi (Yaysız Eğri)**  
*Circlip Pliers Internal (Bent)*

TS 60

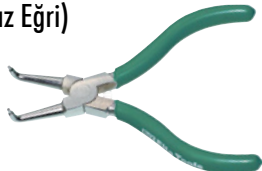

**Krom vanadyum, Krom kaplı, PVC izoleli**  
*Chrom vanadium, Chrom plated, PVC Insulated*

KOD CODE	L mm	⌀	g	□	TL/Ad.
★3324 12 0130	130	8 - 25	90	5	54,00
★3324 12 0170	170	19 - 60	140	5	56,90
★3324 12 0210	210	40 - 100	300	5	67,90

### 4150

**Opak Seri Düz Uçlu Tornavida**  
*Screwdriver, Opak, Flat*

TS ISO 2380 - 1

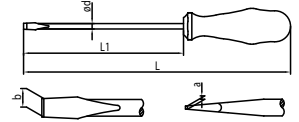

**Krom vanadyum, Krom kaplı, PP saplı**  
*Chrom vanadium, Chrom plated, PP handle.*

KOD CODE	⌀DxL1 mm	⌀		L mm	g	□	TL/Ad.
		a mm	b mm				
★4150 17 7125	7x125	1.2	8	260	110	10	14,70

### 4160

**Ergonom Seri Düz Uçlu Tornavida**  
*Screwdriver, Ergonom, Flat*

TS ISO 2380-1  
DIN ISO 2380-1

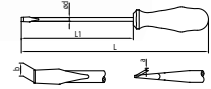

**Krom vanadyum, Krom kaplı, Ucu siyah oksit, İki komponent saplı**  
*Chrom vanadium, Chrom plated and black tips, Two component handle*

KOD CODE	⌀DxL1 mm	⌀		L mm	g	□	TL/Ad.
		a mm	b mm				
★4160 17 0380	3x80	0.5	3	160	25	10	7,60
★4160 17 0480	4x80	0.8	4	170	40	10	8,65
★4160 17 0580	5x80	1.0	5.5	180	45	10	9,60
★4160 17 4100	4x100	0.8	4	190	45	10	9,50
★4160 17 5100	5x100	1.0	5.5	200	60	10	11,50
★4160 17 6100	6x100	1.2	6.5	200	85	10	11,90
★4160 17 5125	5x125	1.0	5.5	225	65	10	13,30
★4160 17 6125	6x125	1.2	6.5	225	90	10	13,65
★4160 17 7125	7x125	1.2	8	235	100	10	13,80
★4160 17 5150	5x150	1.6	10	250	85	10	14,20
★4160 17 6150	6x150	1.2	6.5	250	90	10	14,90
★4160 17 7150	7x150	1.2	8	260	130	10	17,55
★4160 17 8150	8x150	1.6	10	260	135	10	19,35
★4160 17 7175	7x175	1.2	8	285	130	10	20,20

4180

Ergonom Seri Yıldız Uçlu Tornavida  
Screwdriver, Ergonom, Phillips

TS 59 -5 ISO 8764-1  
DIN ISO 8764



Krom vanadyum, Krom kaplı, Ucu siyah oksit, İki komponent saplı  
Chrom vanadium, Chrom plated and black tips,  
Two component handle.

KOD CODE	øDxL1 mm	+	L mm	g	TL/Ad.
★4180 18 0360	3x60	Ph0	140	25	10 8,85
★4180 18 4580	4.5x80	Ph1	170	40	10 11,55
★4180 18 4510	4.5x100	Ph1	190	60	10 12,95
★4180 18 6100	6x100	Ph2	200	70	10 13,90
★4180 18 6150	6x150	Ph2	250	110	10 17,40
★4180 18 8150	8x150	Ph3	260	130	10 26,55

4160

Ergonom Seri Tornavida Seti (6 Parça)  
Screwdriver Set, Ergonom (6 Pcs.)



KOD CODE	İÇERİK CONTENTS	g	TL/Ad.
★4160 00 8106	4x80 - 5x100 6x125 - 7x150 Düz uçlu / Flat 4.5x80 - 6x100 Yıldız uçlu / Phillips	600	6 76,80

Ergonom Seri Tornavida Seti (7 Parça)  
Screwdriver Set, Ergonom (7 Pcs.)

KOD CODE	İÇERİK CONTENTS	g	TL/Ad.
★4160 00 8107	3x80 - 4x80 - 4x100 5x125 - 6x150 Düz uçlu / Flat 4.5x80 - 6x100 Yıldız uçlu / Phillips	670	7 79,40

4181

Değişken Uçlu Tornavida Ergonom  
Screwdriver - Reversible



Krom vanadyum, Krom kaplı, İki komponent saplı  
Chrom vanadium, Chrom plated, Two component handle.

KOD CODE	øDxL1 mm	axb mm	+	L mm	g	TL/Ad.
★4181 17 0680	6x80	6x1.2	Ph2	180	70 10	12,55

4552

Elektrik Kontrol Kalemi  
Voltage Tester

TS 13108

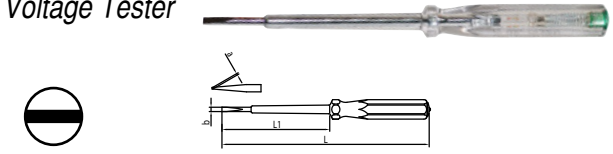

Krom vanadyum, Krom kaplı, Selüloz asetat saplı  
Chrom vanadium, Chrom plated, Cellulose acetate handle

KOD CODE	L mm	a mm	b mm	L1 mm	g	TL/Ad.
★4552 17 0190	190	0.8	4	100	35 10	12,95

4501

Elektronikçi Tip (Klemens) Düz Uçlu Tornavida  
Electronic Screwdriver, Flat

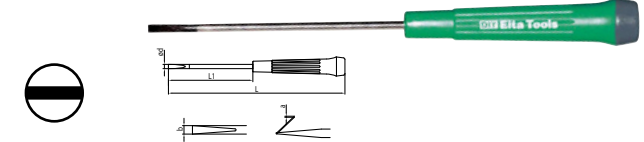

Krom vanadyum, Krom kaplı, Ucu siyah oksit, PP saplı  
Chrom vanadium, Chrom plated and black tips, PP handle

KOD CODE	øDxL1 mm	a mm	b mm	L mm	g	TL/Ad.
★4501 17 3150	3x150	0.5	3	230	20 10	11,50
★4501 17 4150	4x150	0.8	4	230	25 10	12,20

4771

Lokma Uçlu Tornavida (mm)  
Nut Spinner (mm)

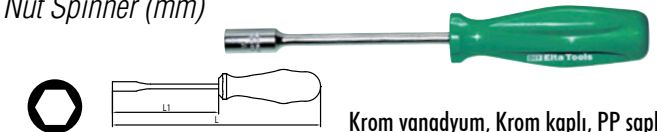

Krom vanadyum, Krom kaplı, PP saplı  
Chrom vanadium, Chrom plated, PP handle

KOD CODE	mm	L mm	L1 mm	g	TL/Ad.
★4771 19 0090	9	235	125	115 10	23,90

## 4811

Düz Bits  
Slotted Bit



KOD CODE	☉	L mm	g	□	TL/Ad.
★4811 20 0645	0.6x4.5	25	5	10	1,50
★4811 20 0855	0.8x5.5	25	5	10	1,50
★4811 20 1265	1.2x6.5	25	5	10	1,50
★4811 20 5645	0.6x4.5	50	10	10	2,30
★4811 20 5855	0.8x5.5	50	10	10	2,30
★4811 20 5265	1.2x6.5	50	10	10	2,30

## 4821

Yıldız Bits  
Phillips Bit



KOD CODE	⊕	L mm	g	□	TL/Ad.
★4821 21 0001	Ph1	25	5	10	1,30
★4821 21 0002	Ph2	25	5	10	1,30
★4821 21 0003	Ph3	25	5	10	1,30
★4821 21 0011	Ph1	50	10	10	2,80
★4821 21 0013	Ph3	50	10	10	2,80

## 4831

Torx® Bits  
Torx® Bit



KOD CODE	★	L mm	g	□	TL/Ad.
★4831 21 0025	T25	25	5	10	1,85
★4831 21 0027	T27	25	5	10	1,85
★4831 21 0030	T30	25	5	10	1,85
★4831 21 0040	T40	25	5	10	1,85
★4831 21 0125	T25	50	10	10	3,15
★4831 21 0127	T27	50	10	10	3,15
★4831 21 0130	T30	50	10	10	3,15
★4831 21 0140	T40	50	10	10	3,15

## 4908

Allen Anahtar Altı Köşe (mm)  
Hex Key Wrench (mm)

TS ISO 2936  
DIN ISO 2936

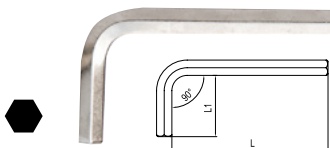

Krom vanadyum, Nikel Kaplı  
Chrom vanadium, Nickel finish

KOD CODE	mm	L mm	L1 mm	g	□	TL/Ad.
★4908 22 0140	14	137	53	250	5	20,00
★4908 22 0170	17	155	60	425	5	35,25

## 4911

Torx® Allen Anahtar  
Torx® Key Wrench

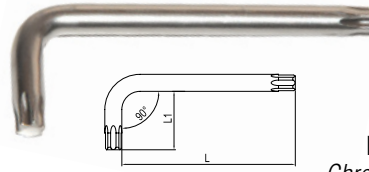

Krom vanadyum, Cinko kaplı  
Chrom vanadium, Zinc Plated

KOD CODE	★	L mm	L1 mm	g	□	TL/Ad.
★4911 22 0006	T6	42	16	2	10	6,75
★4911 22 0007	T7	48	16	2	10	6,75
★4911 22 0008	T8	48	16	3	10	6,75
★4911 22 0009	T9	48	16	3	10	7,45
★4911 22 0020	T20	57	19	5	10	8,00
★4911 22 0027	T27	64	21	15	10	8,00
★4911 22 0030	T30	70	24	20	10	8,65
★4911 22 0045	T45	83	29	40	10	11,25
★4911 22 0050	T50	95	32	60	10	12,80
★4911 22 0055	T55	108	35	125	10	17,85
★4911 22 0060	T60	120	38	185	10	24,60

## 5501

Düz Keski  
Flat Cold Chisel

TS 492  
DIN ISO 6450

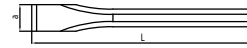

Krom vanadyum, Elektrostatik boyanmış  
Chrom vanadium, Electrostatically painted

KOD CODE	L mm	a mm	mm	g	□	TL/Ad.
★5501 23 0150	150	14	12	140	5	27,60
★5501 23 0175	175	18	12	170	5	31,10
★5501 23 0250	250	22	16	370	5	48,85
★5501 23 0300	300	24	20	645	5	78,30

## 5521

Tırnak Keski  
Cross Cut Chisel

TS 492/1



Krom vanadyum, Elektrostatik boyanmış  
Chrom vanadium, Electrostatically painted

KOD CODE	L mm	a mm	mm	g	□	TL/Ad.
★5521 23 0125	125	5	10	70	10	18,00
★5521 23 0150	150	6	12	110	10	24,05

## 5546

### Konik Pim Zimba Drift Punch

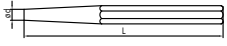

TS 2338  
DIN 6448

Krom vanadyum, Elektrostatik boyanmış  
Chrom vanadium, Electrostatically painted

KOD CODE	L mm	L inch	øD mm	mm	g	TL/Ad.
★5546 24 0002	120	4 3/4"	2	10	55	10
★5546 24 0003	120	4 3/4"	3	10	60	10
★5546 24 0004	120	4 3/4"	4	10	60	10
★5546 24 0005	120	4 3/4"	5	10	65	10
★5546 24 0006	120	4 3/4"	6	10	65	10
★5546 24 0007	120	4 3/4"	7	12	100	10
★5546 24 0008	120	4 3/4"	8	12	100	10
★5546 24 0009	120	4 3/4"	9	12	105	10
★5546 24 0010	120	4 3/4"	10	12	105	10

## 5551

### Düz Pim Zimba Split Pin Punch

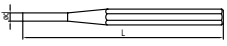

TS 2338  
DIN 6450

Krom vanadyum, Elektrostatik boyanmış  
Chrom vanadium, Electrostatically painted

KOD CODE	L mm	øD mm	g	TL/Ad.
★5551 24 0002	115	2	30	5
★5551 24 0006	180	6	125	5
★5551 24 0008	200	8	155	5
★5551 24 0010	215	10	190	5

## 5701

### Kayış Zimba Belt Punch



DIN 7200

Krom vanadyum, Elektrostatik boyanmış  
Chrom vanadium, Electrostatically painted

KOD CODE	ØD mm	L mm	g	TL/Ad.
★5701 24 0003	3	105	35	10
★5701 24 0004	4	105	45	10
★5701 24 0005	5	110	55	10
★5701 24 0006	6	110	60	10
★5701 24 0007	7	115	70	10
★5701 24 0008	8	115	80	10
★5701 24 0009	9	120	100	10
★5701 24 0010	10	120	115	10
★5701 24 0011	11	125	130	5
★5701 24 0012	12	125	145	5
★5701 24 0013	13	130	160	5
★5701 24 0014	14	130	170	5
★5701 24 0015	15	135	250	5
★5701 24 0016	16	135	300	5
★5701 24 0017	17	140	345	5
★5701 24 0019	19	145	410	5
★5701 24 0020	20	145	440	5

## 5801

### Tesviye Çekiç Machinist Hammer

TS 5  
DIN 1041



Özel alaşımli çelik, İndüksiyonda sertleştirilmiş  
Special steel, Induction hardened

KOD CODE	L mm	L1 mm	g	g	TL/Ad.
★5801 25 0100	260	82	100	145	10
★5801 25 0200	280	95	200	245	10
★5801 25 0500	320	118	500	565	5
★5801 25 1000	360	135	1000	1145	5
★5801 25 1500	380	145	1500	1615	5
★5801 25 2000	400	150	2000	2300	5

## 5851

### Plastik Çekiç Plastic Hammer

TS 5

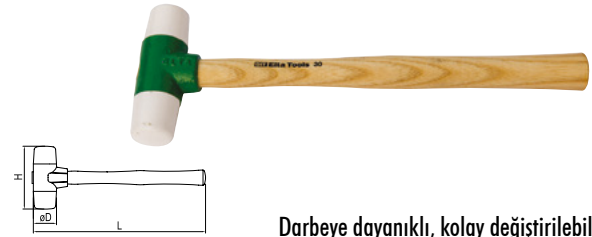

Darbeye dayanıklı, kolay değiştirilebilir başlık  
Durable and easily changeable heads

KOD CODE	L mm	øD mm	H mm	g	TL/Ad.
★5851 25 0030	300	30	100	335	5
★5851 25 0050	350	50	120	1030	5

### Başlık / Head

KOD CODE	ØD mm	g	TL/Ad.
★5851 25 0130	30	35	10
★5851 25 0140	40	70	10

## 6196

### Perçin Tabancası Riveting Pliers



KOD CODE	ÖLÇÜ SIZE	CAPACITY mm	g	TL/Ad.
6196 26 0260	260	2.5 - 3.2 - 4 - 4.8	545	1



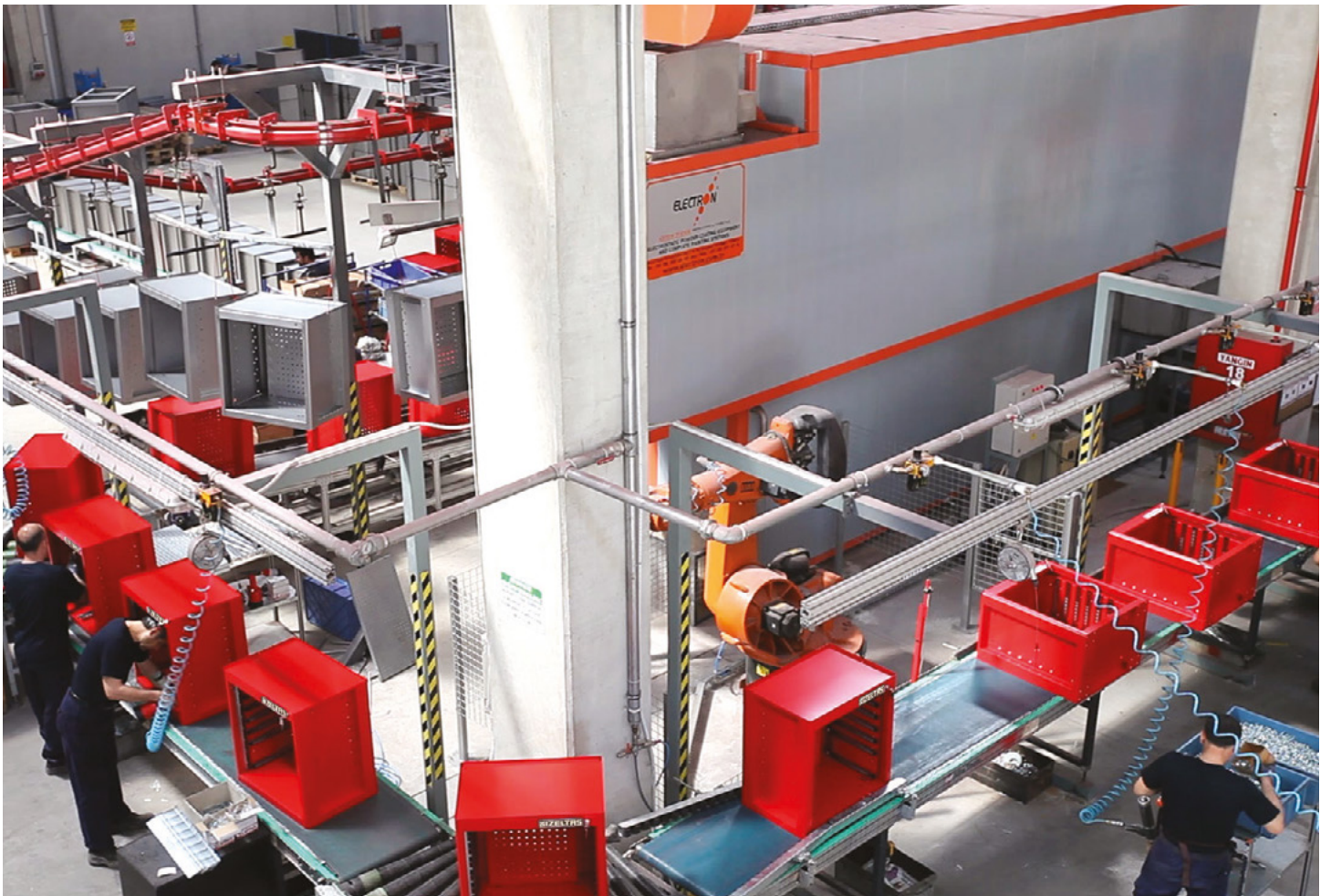

# 15

## Teknik Bilgiler Technical Informations



### Teknik Bilgiler Technical Informations

Do not use any extension that the torque exerted may  
grasp from the handle.  
Do not overload by applying torque exceeds rated  
capacity.

## Güvenlik Uyarıları/Safety Recommendations



### Risk almayın, tedbir alın

İzeltaş El Aletleri, işinizi daha da kolaylaştırmak için her zaman yanınızda olan, özel olarak tasarlanmış en iyi iş arkadaşlarınız. Gelin, onları iş güvenliği kurallarına uyarak, alınacak tedbirleri ihmal etmeyerek kullanalım, sağlığımızı tehlikeye atmayalım.

### Don't take risk, just take the necessary measures

İzeltaş Hand Tools are your best work-friends, specially designed for facilitating your job. Let us use them within taking care of the necessary rules, and do not endanger our lives.



Elektrikle bağlantılı işlerde çalışırken mutlaka VDE 1000V aletlerini kullanınız. Diğer plastik saplar izolasyon amaçlı tasarlanmamıştır.

Use VDE 1000 V tools only while you are working with live components. Other plastic handles of the tools are not designed to insulate.



İşin türüne göre gereken, iş güvenliği ekipmanlarını kullanınız.

Use necessary protection materials according to the specification of the job.



Sıkma ve sökme işlemi daima çekerek yapılmalı.

Tightening and extracting applications must be always do as pulling.



Doğru duruşla, doğru hareketi yapın ve uygun olan aleti kullanın.

Make sure that you are well balanced, doing the right motion and use the suitable tools.



## GÜVENLİK UYARILARI / Safety Recommendations

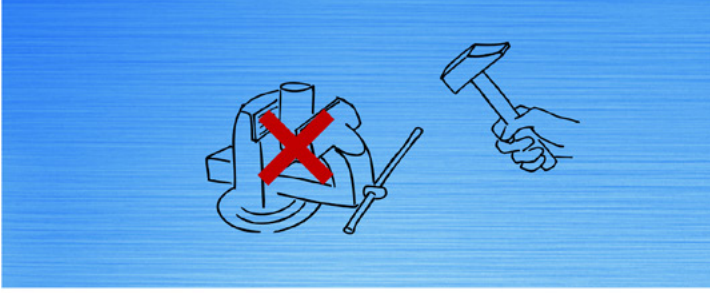

Mengene, işkence türü aletlerin sıkma işleminde çekiç ve uzatma kolu kullanmayınız.

Do not use hammer and extension bar while using kinds of clamping tools.

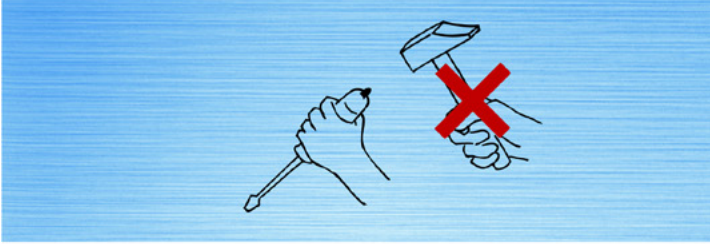

Tornavidanızı keski, punta veya levye yerine kesinlikle kullanmayınız.

Do not use a screwdriver as a chisel or lever.

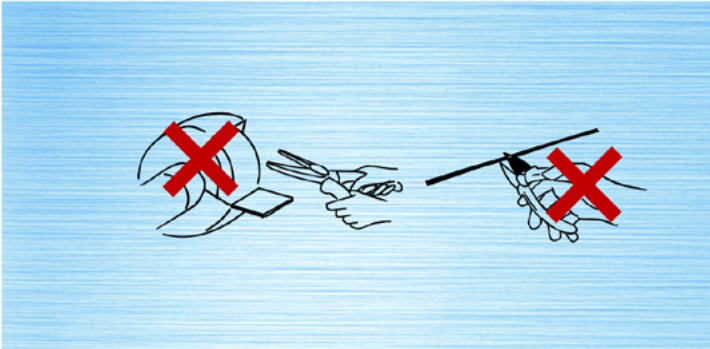

Kesme için uç yerine mafsala yakın yeri kullanınız. Somun ve civata üzerinde kullanmayınız. Çekiç gibi kullanmayınız. Ayarlı (kilitlenebilir) penseleri uzun süre kilitli bırakmayınız, asla basamak gibi kullanmayınız, elemanlar oynayabilir. Asla orijinali bozmayınız.

Use the throat rather than tip of cutting edge. Do not use for bolts and nuts. Do not use like a hammer. Grip pliers should not be used as a permanent clamp, parts can move. Do not modify products.

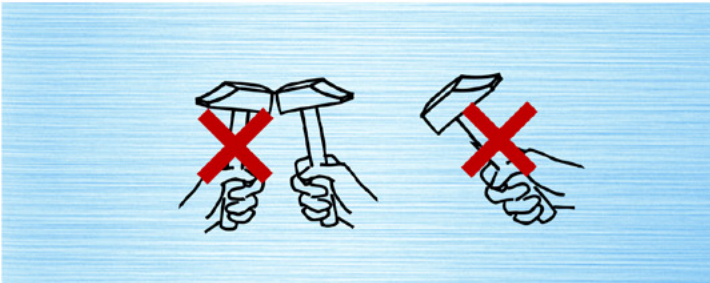

Eşit sertlikteki veya daha sert yüzeylere çekiçle vurmaktan sakınız. Çekiğin çarpma yüzeyinin vurulan alandan geniş olmasına özen gösteriniz (Çekiç kafasının çapı vurulan yüzeyden yaklaşık 10 mm daha geniş olmalıdır). Arızalı, gevşek veya çatlak çekiçleri kesinlikle kullanmayınız.

Never hit on equal or harder surfaces. A hammer should have a diameter approx. 10 mm larger than the surface to hit. Do not use loose, cracked head hammers.

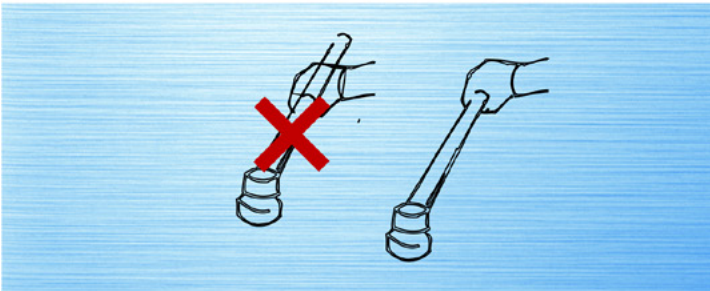

Tork anahtarı ile birlikte asla uzatma kullanmayınız. Doğru ölçümler için daima sap yerinden tutunuz. Kapasitesinin üzerinde yük uygulamayınız. Tork anahtarını sökme amaçlı kullanmayınız.

Do not use any extension with the torque wrenches. Always grasp from the handle. Do not overload by applying torque exceeds rated capacity. Do not use the torque wrench to loosen.

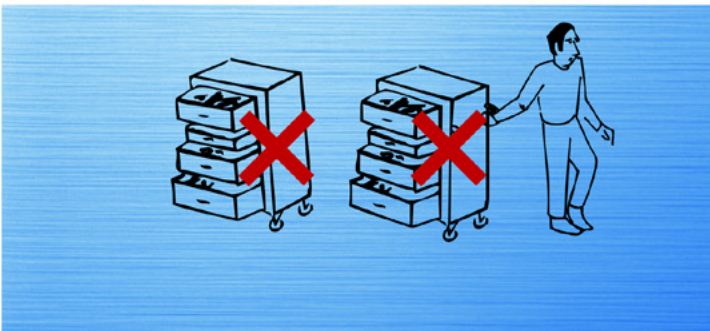

Sabit kullanımda birden fazla çekmece açmayınız. Hareket halinde bütün çekmeceler ve kapılar kapalı olmalı ve üzerinde bir şey bulunmamalıdır.

Do not open more than one drawer during your usage. While moving all drawers, doors must be locked.

## Semboller / Symbols

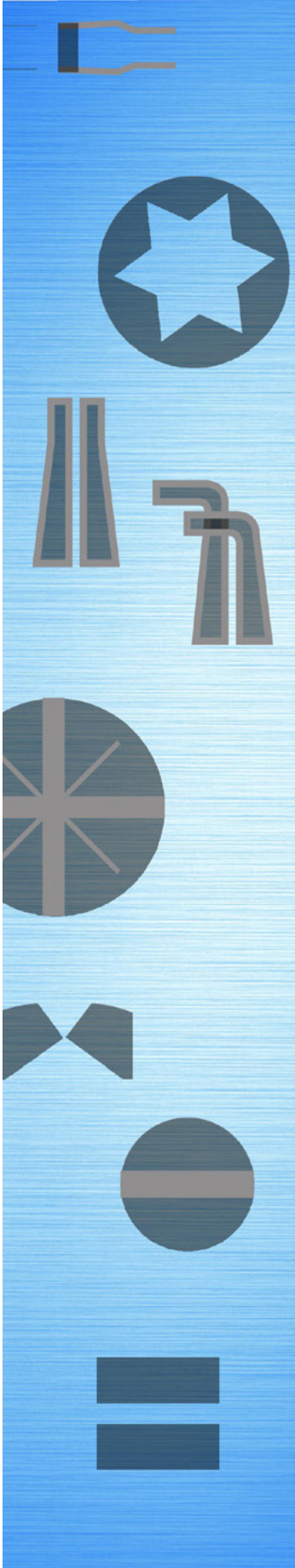

Anahtar Ağız  
Size



Ağız Açıklığı  
Opening Limit of Jaws



Altı Köşe Lokma Bijon  
Anahtar Ağız  
Six Point Sockets



Sekiz Köşe Anahtar Ağız  
Eight Point Wrench



On iki Köşe Anahtar Ağız  
Twelve Point Wrench



Kare Adaptör  
Square Adapter



Kovan Anahtar  
Tubular Socket Wrench



Bir Ağız Bijon Anahtar  
Single Ended Rim Wrench



TORX® Lokma Anahtar  
TORX Socket



Düz Uç  
Flat Tip



Yıldız Uç  
PHILLIPS® Tip



POZIDRIV® Yıldız Uç  
POZIDRIV® Tip



TORX® Uç  
TORX® Tip



Delikli TORX® Uç  
TORX® with hole



Bits Tutucular  
Bit Holders



Allen Anahtar  
Hexagonal Allen Keys



Segman  
Circlip



Gövde Ağırlık  
Weight of Body



Tapa Anahtar  
Wrench for Carter Case



İşkençe  
Screw Clamp



Çektirme  
Puller

# SIKMA / TEST TORK DEĞERLERİ TIGHTENING / TEST TORQUE VALUES

Önerilen (Bağlayıcı olmayan) cıvata sıkma torkları Nm (Newton Metre)  
Suggested (Not Compulsory) Bolt Tightening Torque in Nm (Newton Meter)

**Kalite Sınıfı DIN 267'ye Göre Sıkma Değerleri**  
Tightening Torques Values According to Quality Class DIN 267

	4.6	5.6	6.9	8.8	10.9	12.9
M 2	0,123	0,162	0,314	0,373	0,520	0,628
M 2,2	0,196	0,265	0,510	0,598	0,843	1,010
M 2,5	0,284	0,373	0,726	0,863	1,206	1,451
M 3	0,441	0,588	1,128	1,344	1,883	2,256
M 3,5	0,677	0,902	1,736	2,060	2,893	3,481
M 4	1,000	1,344	2,599	3,040	4,315	5,148
M 5	1,916	2,648	5,099	6,031	8,483	10,200
M 6	3,432	4,511	8,728	10,300	14,710	17,652
M 7	5,590	7,453	14,220	17,162	24,517	28,439
M 8	8,238	10,787	21,575	25,497	35,304	42,168
M 10	16,67	21,575	42,168	50,014	70,608	85,317
M 12	28,44	38,246	73,550	87,279	122,60	147,10
M 14	45,11	60,801	116,70	138,30	194,20	235,40
M 16	69,63	93,163	178,5	210,80	299,10	357,90
M 18	95,12	127,50	245,20	289,3	411,90	490,30
M 20	135,3	180,45	384,10	411,90	578,60	696,30
M 22	182,4	245,16	470,70	559,00	784,50	941,40
M 24	230,5	308,91	598,20	711,00	1000	1196
M 27	343,2	460,90	887,50	1049	1481	1775
M 30	465,8	622,72	1206	1422	2010	2403
M 33	632,5	848,30	1628	1932	2716	3266
M 36	814,0	1089	2099	2481	3491	4197
M 39	1059	1412	2716	3226	4531	5443
M 42	1304	1746	3364	3991	5609	6727
M 45	1638	2177	4207	4992	7012	8414
M 48	1981	2638	5080	6021	8473	10150
M 52	2540	3393	6541	7747	10885	13092
M 56	3168	4227	8149	9650	13582	16279
M 60	3932	5247	10101	11964	16867	20202
M 64	4737	6306	12160	14416	20300	24320

## Ölçü Birimleri Measuring Units

Giga	G	1.000.000.000	=10 <sup>9</sup>	1GW= 1 Milyar Watt
Mega	M	1.000.000	=10 <sup>6</sup>	1 MW= 1 Milyon Watt
Kilo	k	1.000	=10 <sup>3</sup>	1 kW= Bin Watt
Milli	m	0.001	=10 <sup>-3</sup>	1 mm= Binde Bir Watt
Mikro	m	0.000001	=10 <sup>-6</sup>	1 mm= 1 Milyonda Bir Watt
Nano	n	0.000000001	=10 <sup>-9</sup>	1 nm= 1 Milyarda Bir Watt

## Önemli Ölçülerin Değişim Tablosu Conversion Table For Essential Measuring Units

Uzunluk Length	Metre	m		
Kütle Weight	Kilogram	kg		
Zaman Time	Saniye	s		
Kuvvet Force	Newton	N	=kg m/s <sup>2</sup>	1 N= 0.102 kp
Döndürme Mom. Torque	Newtonmetre			9.81 Nm= 1kpm
İş Enerjisi Work	Joule	J	=Nm	
Isı Enerjisi Heat	Joule	J		1 J= 0.239 cal
Güç Power	Watt	W	=Nm/s	1 kW= 1.36 PS=860 kcal/h
Basınç Pressure	Pascal	Pa	=N/m <sup>2</sup>	100.000 Pa=1 bar=10 mWS
Elektrik Akımı Electricity Current	Amper	A		
Sıcaklık Temperature	Kelvin	K		1K= -272.15 °C

## Döndürme Momenti Dönüşüm Tablosu Conversion Table For Bending Moments

Var Olan Ölçüler/ present units	İstenen Ölçüler / Wanted Units					
	=Ncm	=Nm	=kpcm	=kpm	=lbf.in.	=lbf.ft.
Ncm	1	0.01	0.10197	0.00102	0.0885	0.00738
Nm	100	1	10.197	0.10197	8.851	0.7376
kpcm	9.807	0.09807	1	0.01	0.868	0.0723
kpm	980.07	9.807	100	1	86.796	7.233
lbf.in.	11.298	0.11298	1.152	0.01152	1	0.0833
lbf.ft.	135.58	1.3558	13.825	0.13825	12	1

## Newton-Metre ve Librefoot Dönüşüm Tablosu Conversion Table Of Newton-Meter And Librefoot (1 Nm=0.738 lbf.ft.)

Nm	ft.,lbs.									
	0	1	2	3	4	5	6	7	8	9
0	0	0.74	1.48	2.21	2.95	3.69	4.43	5.17	5.90	6.64
10	7.38	8.12	8.86	9.59	10.33	11.07	11.81	12.54	13.28	14.02
20	14.76	15.50	16.2	16.97	17.71	18.45	19.19	19.93	20.65	21.40
30	22.14	22.88	23.62	24.35	25.10	25.83	26.57	27.31	28.04	28.78
40	29.52	30.26	31.00	31.73	32.47	33.21	33.95	34.69	35.42	36.16
50	36.90	37.64	38.38	39.11	39.85	40.59	41.33	42.07	42.80	43.54
60	44.28	45.02	45.76	46.49	47.23	47.97	48.71	49.45	50.18	50.92
70	51.66	52.40	53.14	53.87	54.61	55.35	56.09	56.83	57.56	58.30
80	59.04	59.78	60.52	61.25	62.00	62.73	63.47	64.21	64.94	65.68
90	66.42	67.16	67.90	68.63	69.37	70.11	70.85	71.59	72.32	73.06
100	73.80	74.54	75.28	76.01	76.75	77.49	78.23	78.97	79.70	80.44

## Librefoot ve Newton-Metre Dönüşüm Tablosu Conversion Table Of Librefoot And Newton-Meter (1 lbf.ft.=1.356 Nm)

ft.- lbs.	Nm									
	0	1	2	3	4	5	6	7	8	9
0	0	1.36	2.71	4.07	5.42	6.78	8.14	9.49	10.85	12.20
10	13.56	14.92	16.27	17.63	18.98	20.34	21.70	23.05	24.41	25.76
20	27.12	28.48	29.83	31.19	32.54	33.90	35.26	36.61	37.97	39.32
30	40.68	42.04	43.39	44.75	46.10	47.46	48.82	50.17	51.53	52.88
40	54.24	55.60	56.95	58.31	59.66	61.02	62.38	63.73	65.09	66.44
50	67.80	69.16	70.51	71.87	73.22	74.58	75.94	77.29	78.65	80.00
60	81.36	82.72	84.07	85.43	86.78	88.14	89.50	90.85	92.21	93.56
70	94.92	96.28	97.63	98.99	100.34	101.70	103.06	104.41	105.77	107.12
80	108.48	109.84	111.19	112.55	113.90	115.26	116.62	117.97	119.33	120.68
90	122.04	123.40	124.75	126.11	127.46	128.82	130.18	131.53	132.89	134.24
100	135.60	136.96	138.31	139.67	141.02	142.38	143.74	145.09	146.45	147.80

## Newton-Metre ve Kilopound-Metre Dönüşüm Tablosu Conversion Table Of Newton-Meter and Kilopound-Meter (1 Nm=0.102 kpm)

Nm	kpm									
	0	1	2	3	4	5	6	7	8	9
0	0.00	1.02	2.04	3.06	4.08	5.10	6.12	7.14	8.16	9.18
100	10.20	11.22	12.24	13.26	14.28	15.30	16.31	17.33	18.35	19.37
200	20.39	21.41	22.43	23.45	24.47	25.49	26.51	27.53	28.55	29.57
300	30.59	31.61	32.63	33.65	34.67	35.69	36.71	37.73	38.75	39.77
400	40.79	41.81	42.83	43.85	44.87	45.89	46.91	47.93	48.95	49.97
500	50.99	52.01	53.02	54.04	55.06	56.08	57.10	58.12	59.14	60.16
600	61.18	62.20	63.22	64.24	65.26	66.28	67.30	68.32	69.34	70.36
700	71.38	72.40	73.42	74.44	75.46	76.48	77.50	78.52	79.54	80.56
800	81.58	82.60	83.62	84.64	85.66	86.68	87.70	88.71	89.73	90.75
900	91.77	92.79	93.81	94.83	95.85	96.87	97.89	98.91	99.93	100.95
1000	101.97	102.99	104.01	105.03	106.05	107.07	108.09	109.11	110.13	111.15

## Sertlik Dönüşüm Tablosu

### Hardness Conversion Table

Vickers Sertlik Hardness	Brinell Sertlik Hardness	Rockwell Sertlik Hardness		Çekme dayanımı Tensile Strength
HV 30	HB 30	HRB	HRC	sB N/mm2
80	80.7	36.4	-	270
85	85	42.4	-	290
90	90	47.4	-	310
95	95	52.00	-	320
100	100	56.4	-	340
105	105	60.0	-	360
110	110	63.4	-	380
115	115	66.4	-	390
120	120	69.4	-	410
125	125	72.0	-	420
130	130	74.4	-	440
135	135	76.4	-	460
140	140	78.4	-	470
145	145	80.4	-	490
150	150	82.2	-	500
155	155	83.8	-	520
160	160	85.4	-	540
165	165	86.8	-	550
170	170	88.2	-	570
175	175	89.6	-	590
180	180	90.8	-	600
185	185	91.8	-	620
195	190	91.5	-	640
200	195	94.0	-	660
200	200	95.0	-	670
205	205	95.8	-	680
210	210	96.6	-	710
215	215	97.4	-	720
220	220	98.2	-	730
225	225	99.0	-	750
230	230	-	19.2	760
235	235	-	20.2	780
240	240	-	21.2	800
245	245	-	22.1	820
250	250	-	23.0	830
255	255	-	23.8	850
260	260	-	24.6	870
265	265	-	25.4	880
280	280	-	27.1	900
275	275	-	26.9	920
280	280	-	27.6	940
285	285	-	28.3	950
290	290	-	29.0	970
295	295	-	29.6	990
300	300	-	30.3	1010
310	310	-	31.5	1040
320	320	-	32.7	1080
330	330	-	33.8	1110

Vickers Sertlik Hardness	Brinell Sertlik Hardness	Rockwell Sertlik Hardness		Çekme dayanımı Tensile Strength
HV 30	HB 30	HRB	HRC	sB N/mm2
340	340	-	34.9	1140
350	350	-	36.0	1170
360	359	-	37.0	1200
370	368	-	38.0	1260
380	376	-	38.9	1260
390	385	-	39.8	1290
400	392	-	40.7	1320
410	400	-	41.5	1350
420	408	-	42.4	1380
440	423	-	44.0	1430
450	430	-	44.8	1460
460	-	-	45.6	-
470	-	-	46.3	-
480	-	-	47.0	-
490	-	-	47.7	-
500	-	-	48.3	-
510	-	-	49.1	-
520	-	-	49.7	-
530	-	-	50.4	-
540	-	-	51.0	-
550	-	-	51.6	-
560	-	-	52.2	-
570	-	-	52.8	-
580	-	-	53.3	-
590	-	-	53.9	-
600	-	-	54.4	-
610	-	-	55.0	-
620	-	-	55.5	-
630	-	-	56.0	-
640	-	-	56.5	-
650	-	-	57.0	-
660	-	-	57.5	-
670	-	-	58.0	-
680	-	-	58.5	-
690	-	-	59.0	-
700	-	-	59.5	-
720	-	-	60.4	-
740	-	-	61.2	-
760	-	-	62.0	-
780	-	-	62.8	-
800	-	-	63.6	-
820	-	-	64.3	-
840	-	-	65.0	-
860	-	-	65.7	-
880	-	-	66.3	-
900	-	-	66.9	-
920	-	-	67.5	-
940	-	-	68.0	-

in.	dec.in.	0"	1"	2"	3"	4"	5"	6"	7"	8"	9"	10"	11"
millimeters (mm)													
0	0	0	25.400 0	50.800 0	76.200 0	101.600 0	127.000 0	152.400 0	177.800 0	203.200 0	228.600 0	254.000 0	279.400 0
1/64	0.015 625	0.396 9	25.796 9	51.196 9	76.596 9	101.996 9	127.396 9	152.796 9	178.196 9	203.596 9	228.996 9	254.396 9	279.796 9
1/32	0.031 25	0.793 8	26.193 8	51.593 8	76.993 8	102.393 8	127.793 8	153.193 8	178.593 8	203.993 8	229.393 8	254.793 8	280.193 8
3/64	0.046 875	1.190 6	26.590 6	51.990 6	77.390 6	102.790 6	128.190 6	153.590 6	178.990 6	204.390 6	229.790 6	255.190 6	280.590 6
1/16	0.062 5	1.587 5	26.987 5	52.387 5	77.787 5	103.187 5	128.587 5	153.987 5	179.387 5	204.787 5	230.187 5	255.587 5	280.987 5
5/64	0.078 125	1.984 4	27.384 4	52.784 4	78.184 4	103.584 4	128.984 4	154.384 4	179.784 4	205.184 4	230.584 4	255.984 4	281.384 4
3/32	0.093 75	2.381 2	27.781 2	53.181 2	78.581 2	103.981 2	129.381 2	154.781 2	180.181 2	205.581 2	230.981 2	256.381 2	281.781 2
7/64	0.109 375	2.778 1	28.178 1	53.578 1	78.978 1	104.378 1	129.778 1	155.178 1	180.578 1	205.978 1	231.378 1	256.778 1	282.178 1
1/8	0.125	3.175 0	28.575 0	53.975 0	79.375 0	104.775 0	130.175 0	155.575 0	180.975 0	206.375 0	231.775 0	257.175 0	282.575 0
9/64	0.140 625	3.571 9	28.971 9	54.371 9	79.771 9	105.171 9	130.571 9	155.971 9	181.371 9	206.771 9	232.171 9	257.571 9	282.971 9
5/32	0.156 25	3.968 8	29.368 8	54.768 8	80.168 8	105.568 8	130.968 8	156.368 8	181.768 8	207.168 8	232.568 8	257.968 8	283.368 8
11/64	0.171 875	4.365 6	29.765 6	55.165 6	80.565 6	105.965 6	131.365 6	156.765 6	182.165 6	207.565 6	232.965 6	258.365 6	283.765 6
3/16	0.187 5	4.762 5	30.162 5	55.562 5	80.962 5	106.362 5	131.762 5	157.162 5	182.562 5	207.962 5	233.362 5	258.762 5	284.162 5
13/64	0.203 125	5.159 4	30.559 4	55.959 4	81.359 4	106.759 4	132.159 4	157.559 4	182.959 4	208.359 4	233.759 4	259.159 4	284.559 4
7/32	0.218 75	5.556 2	30.956 2	56.356 2	81.756 2	107.156 2	132.556 2	157.956 2	183.356 2	208.756 2	234.156 2	259.556 2	284.956 2
15/64	0.234 375	5.953 1	31.353 1	56.753 1	82.153 1	107.553 1	132.953 1	158.353 1	183.753 1	209.153 1	234.553 1	259.953 1	285.353 1
1/4	0.25	6.350 0	31.750 0	57.150 0	82.550 0	107.950 0	133.350 0	158.750 0	184.150 0	209.550 0	234.950 0	260.350 0	285.750 0
17/64	0.265 625	6.746 9	32.146 9	57.546 9	82.946 9	108.346 9	133.746 9	159.146 9	184.546 9	209.946 9	235.346 9	260.746 9	286.146 9
9/32	0.281 25	7.143 8	32.543 8	57.943 8	83.343 8	108.743 8	134.143 8	159.543 8	184.943 8	210.343 8	235.743 8	261.143 8	286.543 8
19/64	0.296 875	7.540 6	32.940 6	58.340 6	83.740 6	109.140 6	134.540 6	159.940 6	185.340 6	210.740 6	236.140 6	261.540 6	286.940 6
5/16	0.312 5	7.937 5	33.337 5	58.737 5	84.137 5	109.537 5	134.937 5	160.337 5	185.737 5	211.137 5	236.537 5	261.937 5	287.337 5
21/64	0.328 125	8.334 4	33.734 4	59.134 4	84.534 4	109.934 4	135.334 4	160.734 4	186.134 4	211.534 4	236.934 4	262.334 4	287.734 4
11/32	0.343 75	8.731 2	34.131 2	59.531 2	84.931 2	110.331 2	135.731 2	161.131 2	186.531 2	211.931 2	237.331 2	262.731 2	288.131 2
23/64	0.359 375	9.128 1	34.528 1	59.928 1	85.328 1	110.728 1	136.128 1	161.528 1	186.928 1	212.328 1	237.728 1	263.128 1	288.528 1
3/8	0.375	9.525 0	34.925 0	60.325 0	85.725 0	111.125 0	136.525 0	161.925 0	187.325 0	212.725 0	238.125 0	263.525 0	288.925 0
25/64	0.390 625	9.921 9	35.321 9	60.721 9	86.121 9	111.521 9	136.921 9	162.321 9	187.721 9	213.121 9	238.521 9	263.921 9	289.321 9
13/32	0.406 25	10.318 8	35.718 8	61.118 8	86.518 8	111.918 8	137.318 8	162.718 8	188.118 8	213.518 8	238.918 8	264.318 8	289.718 8
27/64	0.421 875	10.715 6	36.115 6	61.515 6	86.915 6	112.315 6	137.715 6	163.115 6	188.515 6	213.915 6	239.315 6	264.715 6	290.115 6
7/16	0.437 5	11.112 5	36.512 5	61.912 5	87.312 5	112.712 5	138.112 5	163.512 5	188.912 5	214.312 5	239.712 5	265.112 5	290.512 5
29/64	0.453 125	11.509 4	36.909 4	62.309 4	87.709 4	113.109 4	138.509 4	163.909 4	189.309 4	214.709 4	240.109 4	265.509 4	290.909 4
15/32	0.468 75	11.906 2	37.306 2	62.706 2	88.106 2	113.506 2	138.906 2	164.306 2	189.706 2	215.106 2	240.506 2	265.906 2	291.306 2
31/64	0.484 375	12.303 1	37.703 1	63.103 1	88.503 1	113.903 1	139.303 1	164.703 1	190.103 1	215.503 1	240.903 1	266.303 1	291.703 1
1/2	0.5	12.700 0	38.100 0	63.500 0	88.900 0	114.300 0	139.700 0	165.100 0	190.500 0	215.900 0	241.300 0	266.700 0	292.100 0
33/64	0.515 625	13.096 9	38.496 9	63.896 9	89.296 9	114.696 9	140.096 9	165.496 9	190.896 9	216.296 9	241.696 9	267.096 9	292.496 9
17/32	0.531 25	13.493 8	38.893 8	64.293 8	89.693 8	115.093 8	140.493 8	165.893 8	191.293 8	216.693 8	242.093 8	267.493 8	292.893 8
35/64	0.546 875	13.890 6	39.290 6	64.690 6	90.090 6	115.490 6	140.890 6	166.290 6	191.690 6	217.090 6	242.490 6	267.890 6	293.290 6
9/16	0.562 5	14.287 5	39.687 5	65.087 5	90.487 5	115.887 5	141.287 5	166.687 5	192.087 5	217.487 5	242.887 5	268.287 5	293.687 5
37/64	0.578 125	14.684 4	40.084 4	65.484 4	90.884 4	116.284 4	141.684 4	167.084 4	192.484 4	217.884 4	243.284 4	268.684 4	294.084 4
19/32	0.593 75	15.081 2	40.481 2	65.881 2	91.281 2	116.681 2	142.081 2	167.481 2	192.881 2	218.281 2	243.681 2	269.081 2	294.481 2
39/64	0.609 375	15.478 1	40.878 1	66.278 1	91.678 1	117.078 1	142.478 1	167.878 1	193.278 1	218.678 1	244.078 1	269.478 1	294.878 1
5/8	0.625	15.875 0	41.275 0	66.675 0	92.075 0	117.475 0	142.875 0	168.275 0	193.675 0	219.075 0	244.475 0	269.875 0	295.275 0
41/64	0.640 625	16.271 9	41.671 9	67.071 9	92.471 9	117.871 9	143.271 9	168.671 9	194.071 9	219.471 9	244.871 9	270.271 9	295.671 9
21/32	0.656 25	16.668 8	42.068 8	67.468 8	92.868 8	118.268 8	143.668 8	169.068 8	194.468 8	219.868 8	245.268 8	270.668 8	296.068 8
43/64	0.671 875	17.065 6	42.465 6	67.865 6	93.265 6	118.665 6	144.065 6	169.465 6	194.865 6	220.265 6	245.665 6	271.065 6	296.465 6
11/16	0.687 5	17.462 5	42.862 5	68.262 5	93.662 5	119.062 5	144.462 5	169.862 5	195.262 5	220.662 5	246.062 5	271.462 5	296.862 5
45/64	0.703 125	17.859 4	43.259 4	68.659 4	94.059 4	119.459 4	144.859 4	170.259 4	195.659 4	221.059 4	246.459 4	271.859 4	297.259 4
23/32	0.718 75	18.256 2	43.656 2	69.056 2	94.456 2	119.856 2	145.256 2	170.656 2	196.056 2	221.456 2	246.856 2	272.256 2	297.656 2
47/64	0.734 375	18.653 1	44.053 1	69.453 1	94.853 1	120.253 1	145.653 1	171.053 1	196.453 1	221.853 1	247.253 1	272.653 1	298.053 1
3/4	0.75	19.050 0	44.450 0	69.850 0	95.250 0	120.650 0	146.050 0	171.450 0	196.850 0	222.250 0	247.650 0	273.050 0	298.450 0
49/64	0.765 625	19.446 9	44.846 9	70.246 9	95.646 9	121.046 9	146.446 9	171.846 9	197.246 9	222.646 9	248.046 9	273.446 9	298.846 9
25/32	0.781 25	19.843 8	45.243 8	70.643 8	96.043 8	121.443 8	146.843 8	172.243 8	197.643 8	223.043 8	248.443 8	273.843 8	299.243 8
51/64	0.796 875	20.240 6	45.640 6	71.040 6	96.440 6	121.840 6	147.240 6	172.640 6	198.040 6	223.440 6	248.840 6	274.240 6	299.640 6
13/16	0.812 5	20.637 5	46.037 5	71.437 5	96.837 5	122.237 5	147.637 5	173.037 5	198.437 5	223.837 5	249.237 5	274.637 5	300.037 5
53/64	0.828 125	21.034 4	46.434 4	71.834 4	97.234 4	122.634 4	148.034 4	173.434 4	198.834 4	224.234 4	249.634 4	275.034 4	300.434 4
27/32	0.843 75	21.431 2	46.831 2	72.231 2	97.631 2	123.031 2	148.431 2	173.831 2	199.231 2	224.631 2	250.031 2	275.431 2	300.831 2
55/64	0.859 375	21.828 1	47.228 1	72.628 1	98.028 1	123.428 1	148.828 1	174.228 1	199.628 1	225.028 1	250.428 1	275.828 1	301.228 1
7/8	0.875	22.225 0	47.625 0	73.025 0	98.425 0	123.825 0	149.225 0	174.625 0	200.025 0	225.425 0	250.825 0	276.225 0	301.625 0
57/64	0.890 625	22.621 9	48.021 9	73.421 9	98.821 9	124.221 9	149.621 9	175.021 9	200.421 9	225.821 9	251.221 9	276.621 9	302.021 9
29/32	0.906 25	23.018 8	48.418 8	73.818 8	99.218 8	124.618 8	150.018 8	175.418 8	200.818 8	226.218 8	251.618 8	277.018 8	302.418 8
59/64	0.921 875	23.415 6	48.815 6	74.215 6	99.615 6	125.015 6	150.415 6	175.815 6	201.215 6	226.615 6	252.015 6	277.415 6	302.815 6
15/16	0.937 5	23.812 5	49.212 5	74.612 5	100.012 5	125.412 5	150.812 5	176.212 5	201.612 5	227.012 5	252.412 5	277.812 5	303.212 5
61/64	0.953 125	24.209 4	49.609 4	75.009 4	100.409 4	125.809 4	151.209 4	176.609 4	202.009 4	227.409 4	252.809 4	278.209 4	303.609 4
31/32	0.968 75	24.606 2	50.006 2	75.406 2	100.								



“50 yıldır aileden biri”



## YASAL UYARI

Bu katalog, önceki baskıların yerine geçer.

Katalog içeriğinde yer alan ürünlerin teknik özellikleri, görünümü, ölçüleri mevcut şartları temsil etmektedir. Firmanın, gerektiğinde ürünlerle ilgili değişiklik yapma hakkı saklıdır.

Ürün kataloğu ve içeriğindeki tüm görsellerin telif hakkı İZELTAŞ İzmir El Aletleri Sanayi ve Ticaret A.Ş.'ye aittir. İzinsiz kullanılması ve çoğaltılması yasaktır.

Kullanıcı, katalogdaki ürünlerle ilgili güvenlik uyarılarına uymakla yükümlüdür. Bu uyarılara uyulmaması durumunda ortaya çıkacak zararlardan firma sorumlu tutulamaz

**Grafik Tasarım ve Düzenleme**

**İZELTAŞ İzmir El Aletleri Sanayi ve Ticaret A.Ş.**

**İZELTAS®**

[www.izeltas.com.tr](http://www.izeltas.com.tr)



**IZELTAS**  
İZMİR EL ALETLERİ SANAYİ VE TİCARET A.Ş.

Kemalpaşa Caddesi No: 303 Işıkkent İzmir - TÜRKİYE

**İNTERNET ADRESİMİZ / WEB ADDRESS**

www.izeltas.com.tr info@izeltas.com.tr

**SİPARİŞ TEL / PHONE FOR ORDERS**

Direkt: +90.232 472 13 92  
Santral Tel: +90.232 472 13 75  
Fax: +90.232 472 13 78

**ANKARA BÖLGE MÜDÜRLÜĞÜ:  
ANKARA OFFICE:**

Alinteri Bulvarı Alinteri Plaza 23 / 3  
OSTİM ANKARA  
Tel: +90.312 385 24 83 - 385 24 28  
Fax: +90.312 385 04 13

**İSTANBUL BÖLGE MÜDÜRLÜĞÜ:  
İSTANBUL OFFICE:**

Tel: +0533 603 4181 - 0535 461 5487